



UR32

Industrial Cellular Router

Quick Start Guide



Welcome

Thank you for choosing Ursalink UR32 industrial cellular router.

This guide describes how to install the UR32 and how to log in the Web GUI to configure the device. Once you complete the installation, refer to the Ursalink UR32 User Guide for instructions on how to perform configurations on the device.

Related Documents

This Start Guide only explains the installation of Ursalink UR32 router. For more functionality and advanced settings, please refer to the relevant documents as below.

Document	Description
Ursalink UR32 Datasheet	Datasheet for the Ursalink UR32 industrial cellular router.
Ursalink UR32 User Guide	Users could refer to the guide for instruction on how to log in the web GUI, and how to configure all the settings.

The related documents are available on Ursalink website: <http://www.ursalink.com>.

Declaration of Conformity

UR32 are in conformity with the essential requirements and other relevant provisions of the CE, FCC, and RoHS.

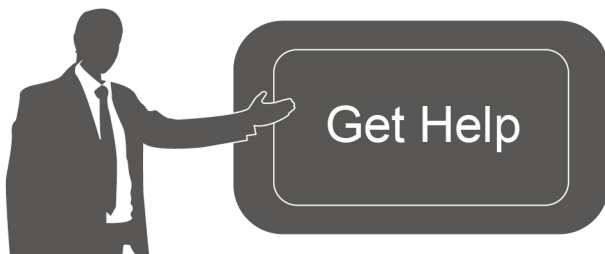

For assistance, please contact
Ursalink technical support:
Email: support@ursalink.com
Tel: 86-592-5023060
Fax: 86-592-5023065

1. Packing List

Before you begin to install the UR32 router, please check the package contents to verify that you have received the items below.

1.1 Package Contents

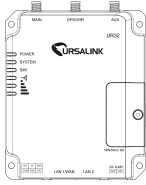

1 × UR32

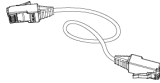

1 × Ethernet Cable

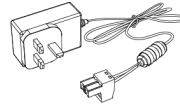

1 × Power Adapter



2 × Magnetic Cellular Antennas



1 × 6-Pin Pluggable Terminal

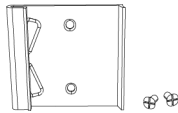

1 × DIN Rail Kit

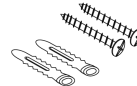

4 × Setscrews



1 × Warranty Card



2 × Stubby Cellular Antennas (Optional)



1 × Stubby Wi-Fi Antenna (Wi-Fi Version Only)



1 × GPS Antenna (GPS Version Only)



If any of the above items is missing or damaged, please contact your Ursalink sales representative.

2. Hardware Introduction

2.1 Overview

A. Front Panel

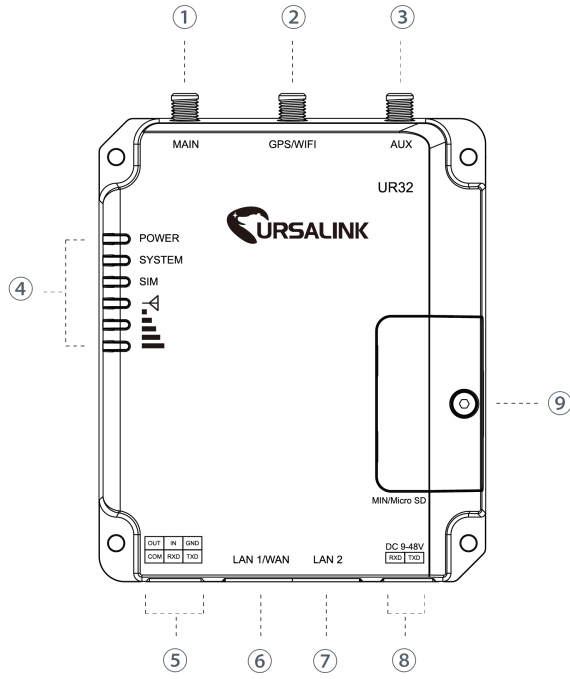

- ① Main Cellular Antenna Connector
- ② GPS/WIFI Antenna Connector
- ③ AUX Cellular Antenna
- ④ LED Indicator Area
 POWER: Power Indicator
 SYSTEM: Status Indicator
 SIM : Status Indicator
 ∇: Signal Strength Indicator
- ⑤ Serial Port & I/O
- ⑥ Ethernet LAN1/WAN Port
- ⑦ Ethernet LAN2 Port
- ⑧ Power Connector
- ⑨ SIM and Reset Button Holder

2.2 Dimensions (mm)

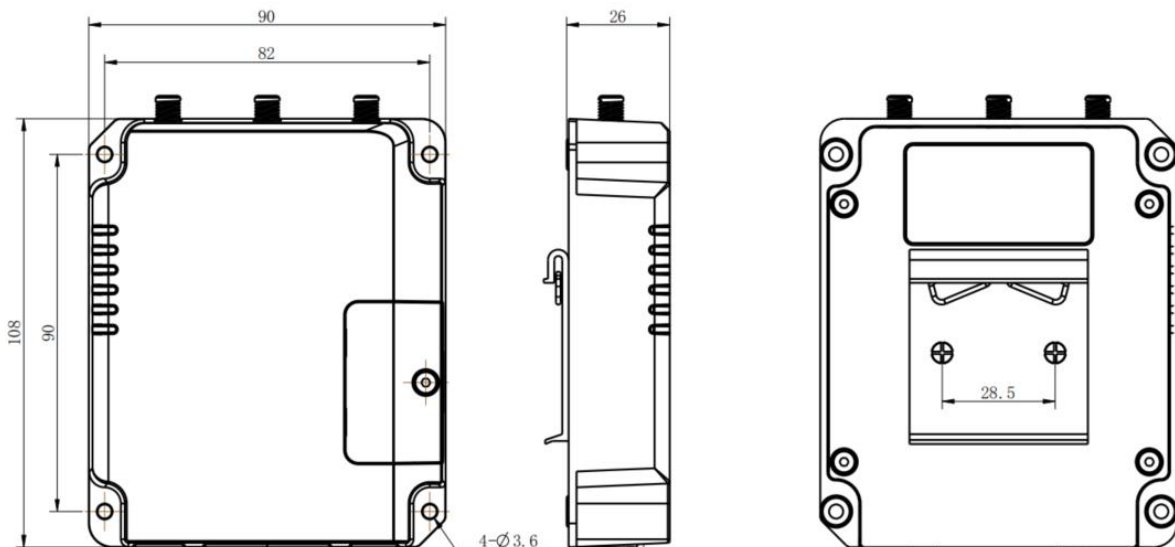

2.3 Pinouts

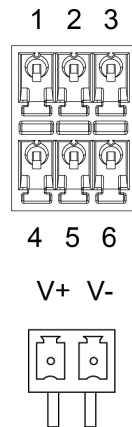

PIN	RS232	DI	DO	Description
1	---	---	OUT	Digital Output
2	---	IN	---	Digital Input
3	GND	---	---	Ground
4	---	COM	COM	Common Ground
5	RXD	---	---	Receive Data
6	TXD	---	---	Transmit Data

PIN	Description
7	Positive
8	Negative

2.4 LED Indicators

LED	Indication	Status	Description
POWER	Power Status	Off	The power is switched off
		On	The power is switched on
SYSTEM	System Status	Green Light	Static: Start-up Blinking slowly: the system is running properly
		Red Light	The system goes wrong
SIM	SIM Card Status	Off	SIM1 or SIM2 is registering or fails to register (or there are no SIM cards inserted)
		Green Light	Blinking slowly: SIM1 has been registered and is ready for dial-up
			Blinking rapidly: SIM1 has been registered and is dialing up now
			Static: SIM1 has been registered and dialed up successfully
		Orange Light	Blinking slowly: SIM2 has been registered and is ready for dial-up
			Blinking rapidly: SIM2 has been registered and is dialing up now
Static: SIM2 has been registered and dialed up successfully			
Signal Strength	Signal 1/2/3	Off	No signal
		Green Light	Static/Off/Off: weak signals with 1-10 ASU (please check if the antenna is installed correctly, or move the antenna to a suitable location to get better signal)
			Static/Static/Off: normal signals with 11-20 ASU (average signal strength)
			Static/Static/Static: strong signals with 21-31 ASU (signal is good)

2.5 Reset Button

Function	Description	
	SYSTEM LED	Action
Reset	Blinking	Press and hold the reset button for more than 5 seconds.
	Static Green → Rapidly Blinking	Release the button and wait.
	Off → Blinking	The router is now reset to factory defaults.

2.6 Ethernet Port Indicator

Indicator	Status	Description
Link Indicator (Orange)	On	Connected
	Blinking	Transmitting data
	Off	Disconnected

3. Hardware Installation

Environmental Requirements

- Power Input: 9-48 VDC
- Power Consumption: Typical 1.9W (Max 2.4 W)
- Operating Temperature: -40°C to 70°C (-40°F -158°F)
- Relative Humidity: 0% to 95% (non-condensing) at 25°C/77°F

3.1 SIM Card/Micro SD Card Installation

A. Unscrew the cover of the SIM card then take it off.

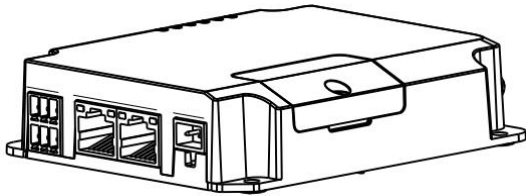

B. Put SIM card/Micro SD into the slot and screw it up.

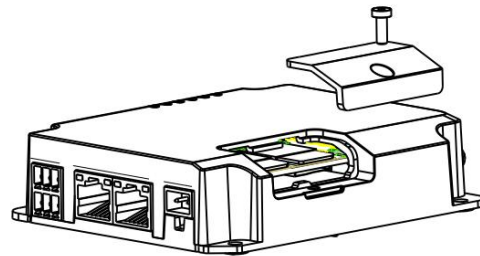

3.2 Antenna Installation

Rotate the antenna into the antenna connector accordingly.

The external antenna should be installed vertically always on a site with a good signal.

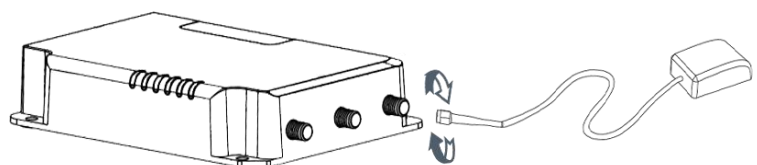
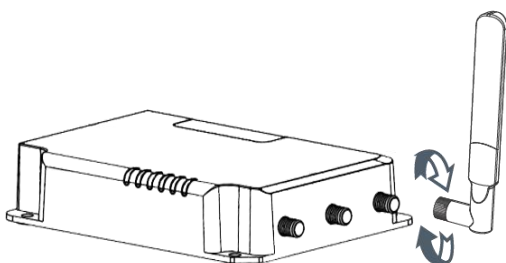

3.3 Connect the Router to a Computer

Please connect PC to LAN port of UR32 router.

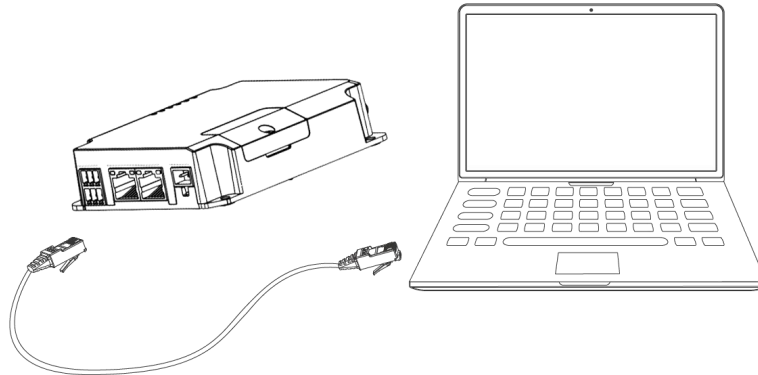

3.4 Mount the Router

The router can be placed on a desktop or mounted to a wall or a DIN rail.

3.4.1 Wall Mounting (Measured in mm)

Use 4 pcs of M3 × 6 flat head Phillips screws to fix the router on the wall.



Recommended torque for mounting is 1.0 N·m, and the maximum allowed is 1.2 N·m.

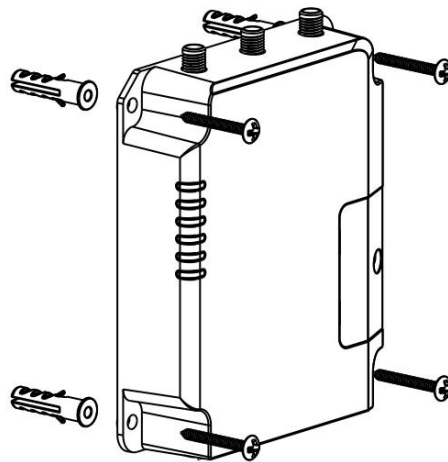

3.4.2 DIN Rail Mounting (Measured in mm)

Use 2 pcs of M3 × 6 flat head Phillips screws to fix the DIN rail to the router, and then hang the DIN rail on the mounting bracket. It is necessary to choose a standard bracket.



Recommended torque for mounting is 1.0 N·m, and the maximum allowed is 1.2 N·m.

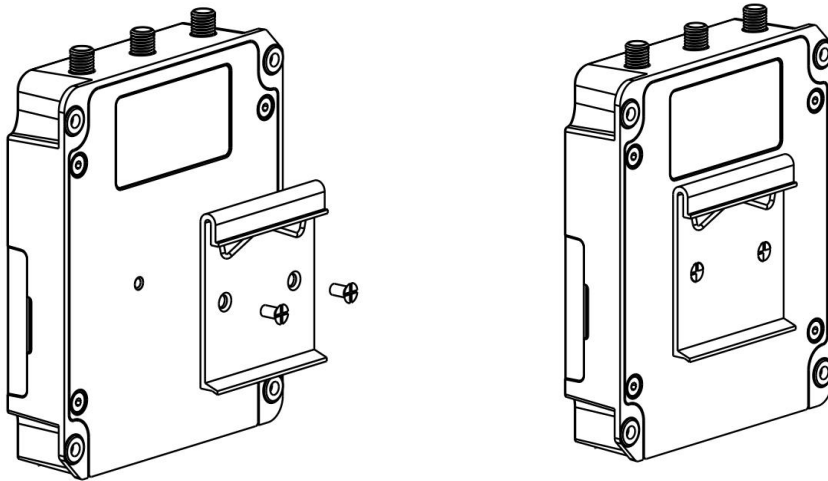

3.5 Power Supply Installation

- A. Take out the terminal from the router and unscrew the bolt on the terminal.
- B. Screw down the bolt after inserting power cable into the terminal.

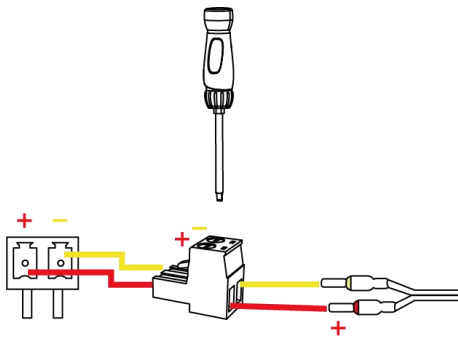

Connecting the Power Cable

Color	Polarity
Red	+
Yellow	-



If you insert wires into the reverse holes, the router will not start and you must switch the wires into the correct holes.

Getting Started

4. PC Configuration for Web GUI Accessing to Router

Please connect PC to LAN port of UR32 router. PC can obtain an IP address, or you can configure a static IP address manually. The following steps are based on Windows 10 operating system for your reference. (Note: As remote access is disabled by default, you can't access to the router's Web GUI if you connect PC to WAN port of the router. But it will function properly if you enable it on Web GUI.)

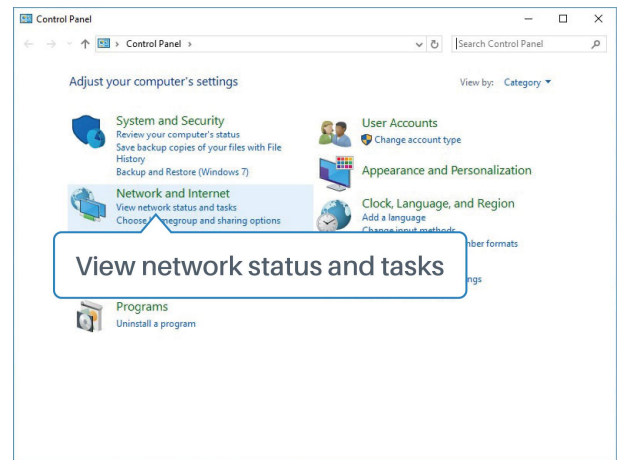
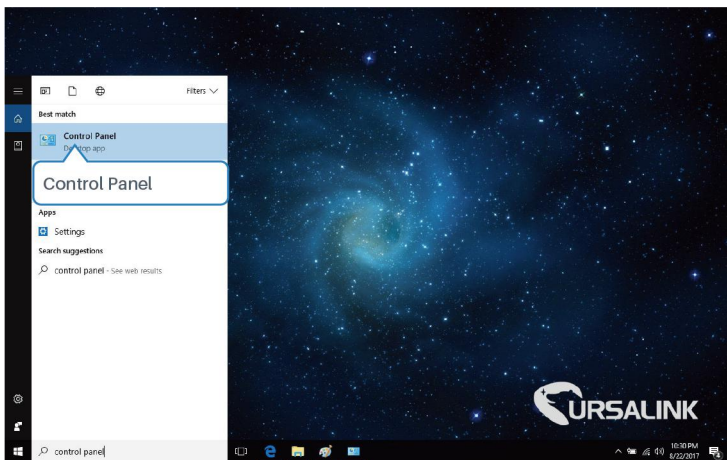

① Click “Search Box” to search “Control Panel” on the Windows 10 taskbar.

② Click “Control Panel” to open it, and then click “View network status and tasks”.

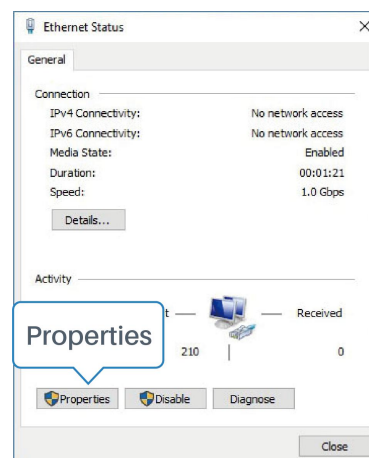
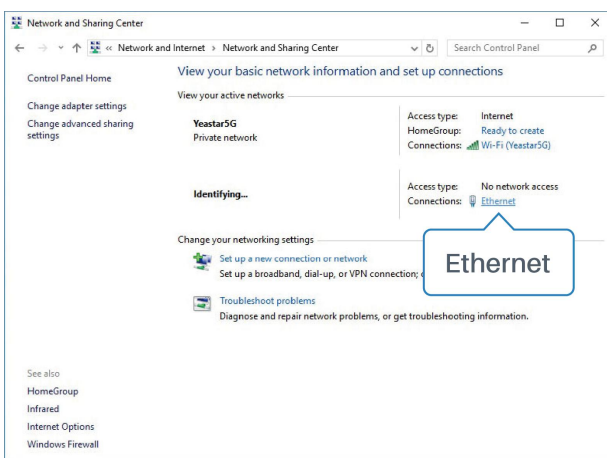

③ Click “Ethernet” (May have different names).

④ Click “Properties”.

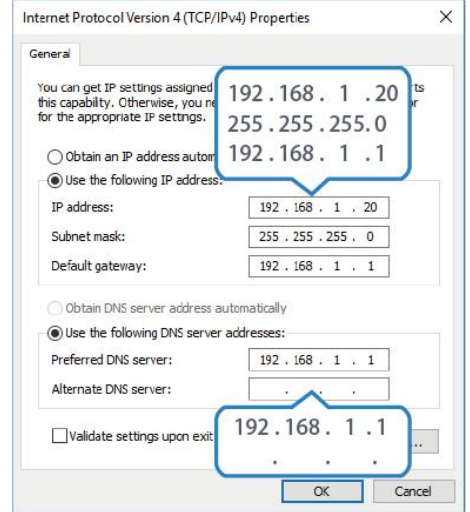
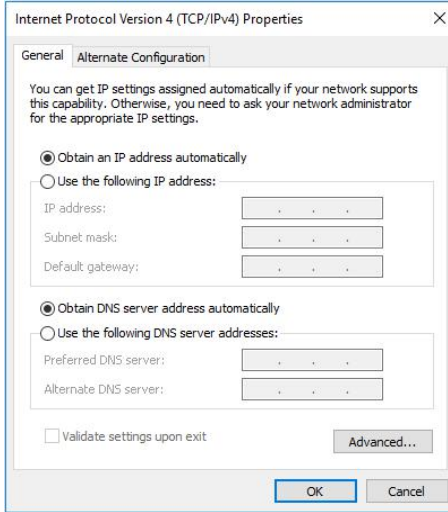
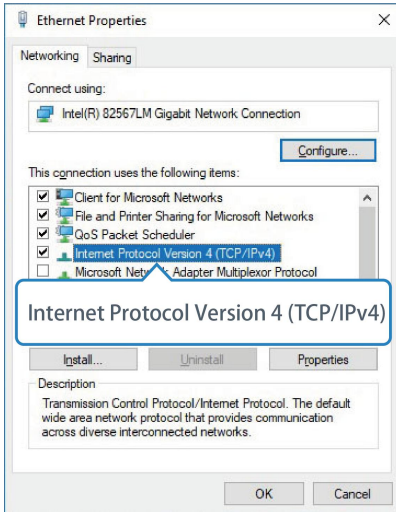

⑤ Double Click “Internet Protocol Version 4 (TCP/IPv4)” to configure IP address and DNS server.

⑥ Method 1: click “Obtain an IP address automatically”;

Method 2: click “Use the following IP address” to assign a static IP manually within the same subnet of the router.

(Note: Remember to click “OK” to finish configuration.)

5. Access to Web GUI of Router for Network Connection

This chapter explains how to log in UR32 router’s Web GUI, and connect the router to network. Ursalink router provides Web-based configuration interface for management. If this is the first time you configure the router, please use the default settings below:

IP Address: **192.168.1.1**

Username: **admin**

Password: **password**

5.1 Log in the Router

 **Make sure your PC is connected to the same network as the router as per [Section 4](#).**

- A. Start a Web browser on your PC (Chrome and IE are recommended), type in the IP address, and press Enter on your keyboard.
- B. Enter the username and password, click “Login”.

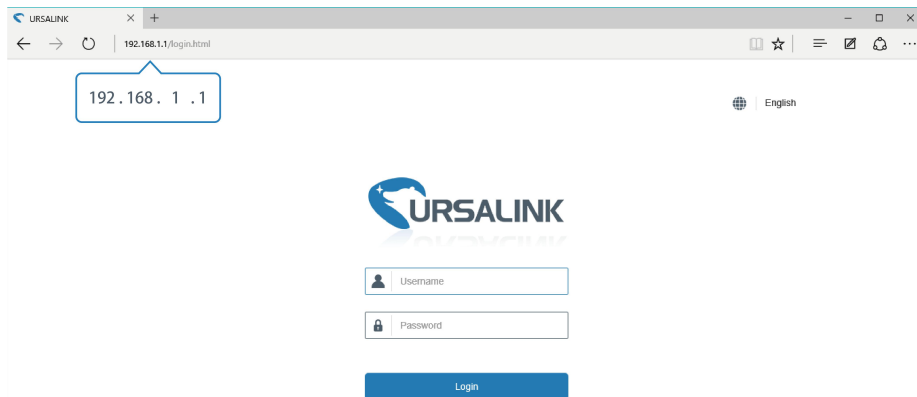

 **If you enter the username or password incorrectly more than 5 times, the login page will be locked for 10 minutes.**

C. When you log in with the default username and password, you will be asked to modify the password. It’s suggested that you change the password for the sake of security. Click “Cancel” button if you want to modify it later.

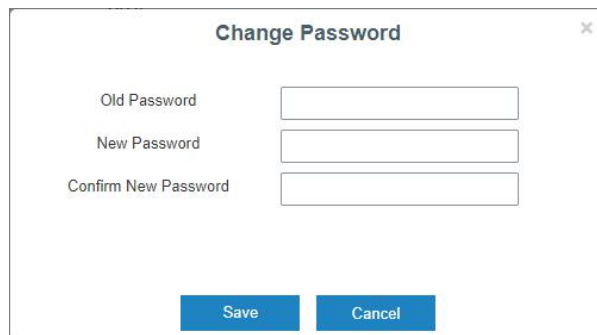

D. After you log in the Web GUI, you can view system information and perform configuration on the router.

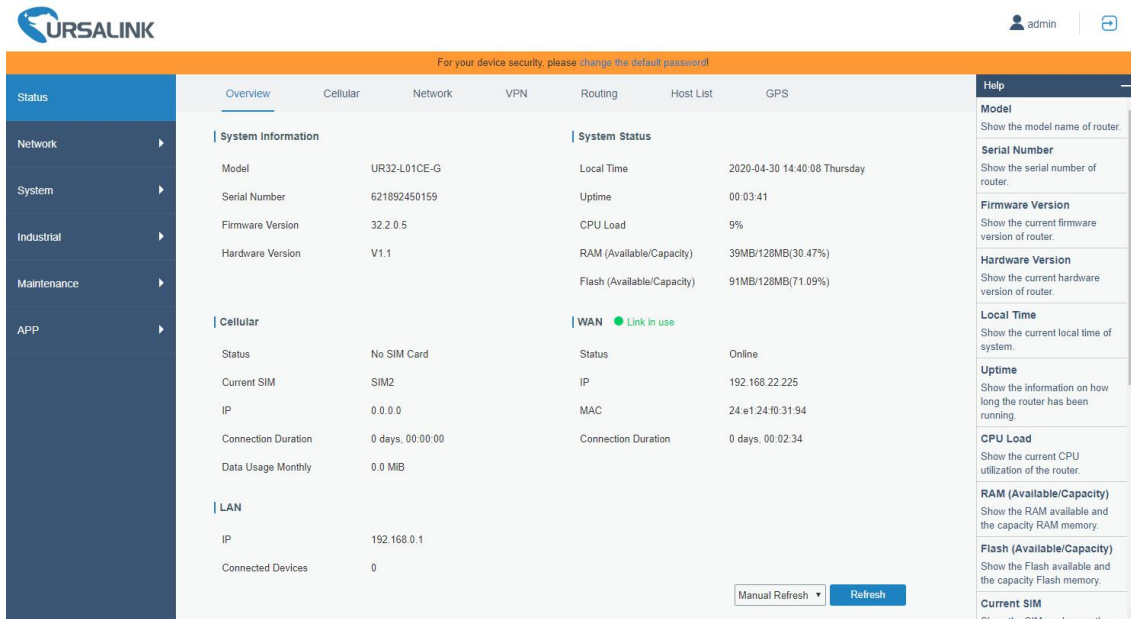

5.2 Configure the Cellular Connection

Take inserting SIM card into SIM1 slot as an example; please refer to the following detailed operations.

- Click “Network > Interface > Cellular > Cellular Setting” to configure the cellular info, like APN and network type.
- Click “Save” and “Apply” for configuration to take effect.

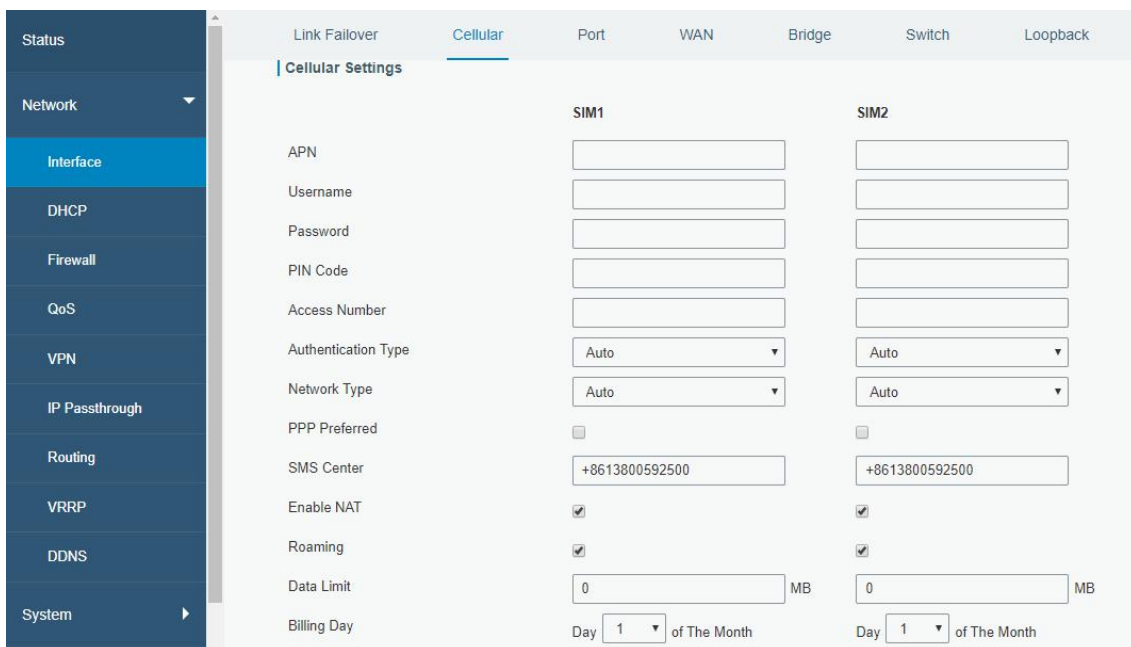

If you select “Auto”, the router will obtain ISP information from SIM card to set APN, Username, and Password automatically. This option will only be taken effect when the SIM card is issued from a well-known ISP.

- Go to “Network > Interface > Link Failover” to enable SIM1 and rise link priority of SIM1.

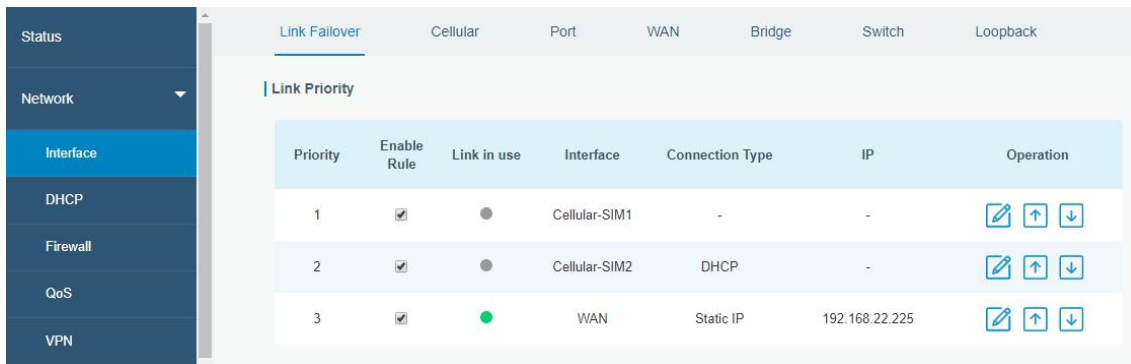

D. Click to configure ICMP ping detection information.

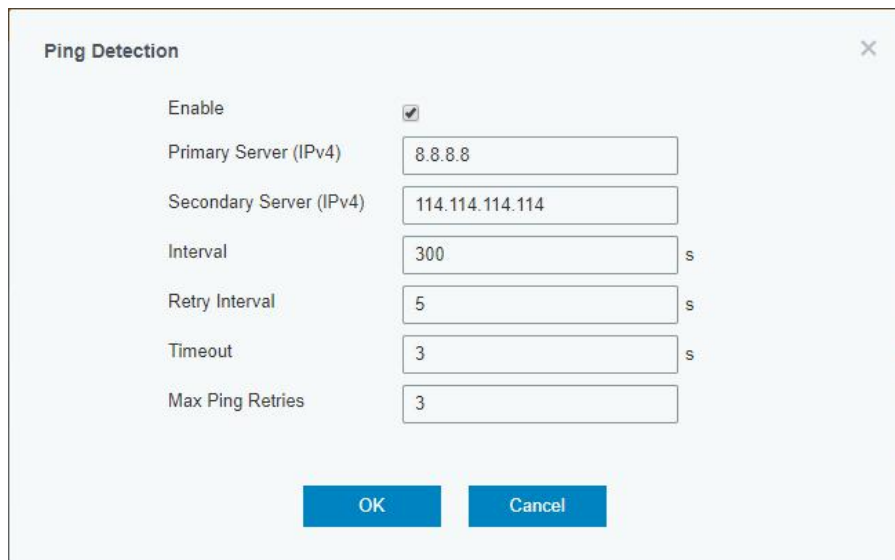

E. Click “Status > Cellular” to view the status of the cellular connection. If it shows “Connected”, it means SIM1 has dialed up successfully.

On the other hand, you can check the status of SIM indicator. If it keeps on green light statically, it means SIM1 has dialed up successfully.

Overview	Cellular	Network	VPN	Routing	Host List	GPS	
Modem		Network					
Status	Ready	Status	Connected				
Model	EC25	IP Address	10.2.25.74				
Current SIM	SIM1	Netmask	255.255.255.240				
Signal Level	29asu (-55dBm)	Gateway	10.2.25.73				
Register Status	Registered (Home network)	DNS	211.136.17.107				
IMEI	861585042050250	Connection Duration	0 days, 00:00:34				
IMSI	460045927703654	Data Usage Monthly					
ICCID	89860439101880723654	SIM-1	RX: 0.0 MiB TX: 0.0 MiB ALL: 0.0 MiB				
ISP	CHINA MOBILE	SIM-2	RX: 0.0 MiB TX: 0.0 MiB ALL: 0.0 MiB				
Network Type	FDD LTE						
PLMN ID	46000						
LAC	592f						
Cell ID	271f848						

F. Open your preferred browser on PC, then type any available web address into address bar and see if it is able to visit Internet via UR32 router.

5.3 Ethernet WAN Connection

A. Go to “Network > Interface > WAN” to configure WAN parameters.

Take static IP configuration as an example. DHCP client and PPPoE type are optional according to your requirements.

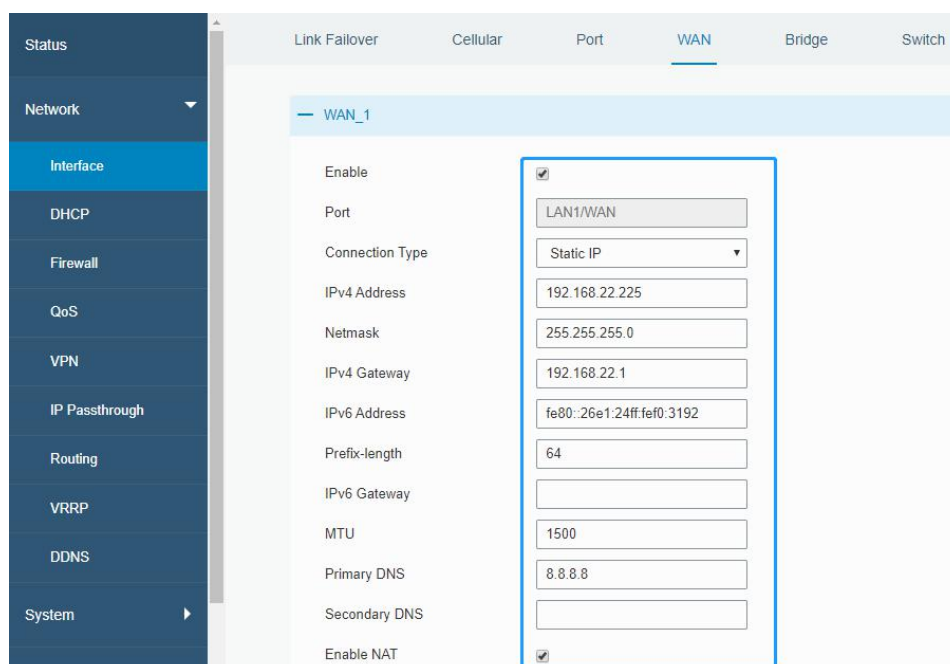

Click “Save & Apply” button to make the changes take effect.

B. Go to “Network > Interface > Link Failover” to rise the WAN priority to 1.

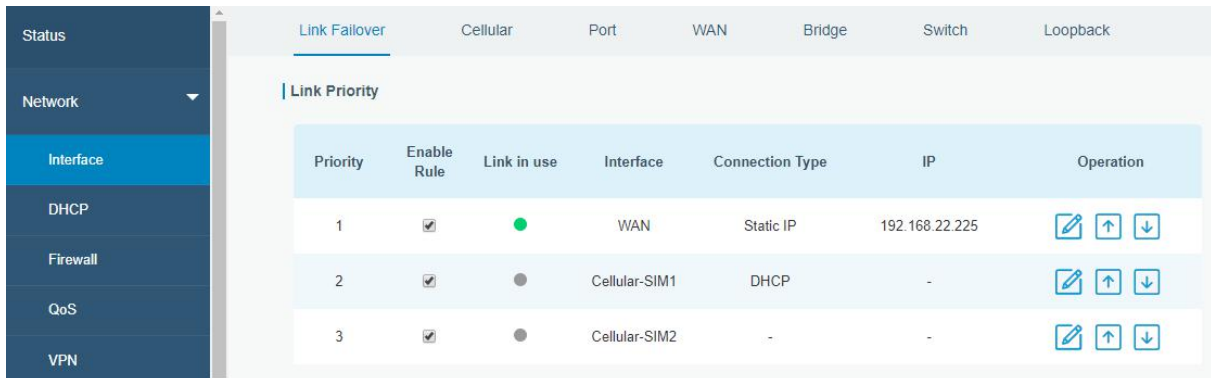

Priority	Enable Rule	Link in use	Interface	Connection Type	IP	Operation
1	<input checked="" type="checkbox"/>	●	WAN	Static IP	192.168.22.225	
2	<input checked="" type="checkbox"/>	●	Cellular-SIM1	DHCP	-	
3	<input checked="" type="checkbox"/>	●	Cellular-SIM2	-	-	

C. Go to “Status > Network” to check if status is “up”.



Port	Status	Type	IP	Netmask	Gateway	DNS	Connection Duration
LAN1/WAN	up	Static	192.168.22.225	255.255.255.0	192.168.22.1	8.8.8.8	08h 22m 29s

D. Open your preferred browser on PC, then type any available web address into address bar and see if it is able to visit Internet via UR32 router.

[END]