



TAOGLAS®



Datasheet

Guardian 8 in 1 Antenna

Part No:
MA9908.A.002.wm

Description:

Guardian X 1m 8in1 1*Active GNSS 4*LTE/5GNR MIMO 3*Wi-Fi MIMO

Features:

Low-profile Housing with Wall Mount

4* LTE/5G NR 600MHz – 6GHz MIMO

3* Wi-Fi MIMO 2.4GHz/5.8 GHz

1* GPS-GLONASS-Galileo Antenna

Sub 6GHz 5G NR/FR1

Worldwide 4G Bands including 3G and 2G

IP67 Waterproof Enclosure

Dimensions: 360mm * 160mm * 16.5mm

1m Low Loss TGC-200 and RG-174 with SMA(M)/RP-SMA(M) connectors

Custom Cables and Connectors Available

RoHS & REACH Compliant

1. Introduction	3
2. Specifications	4
3. Active Antenna Characteristics	9
4. Antenna Characteristics	15
5. Radiation Patterns	20
6. Mechanical Drawing	67
7. Packaging	68
Changelog	69

Taoglas makes no warranties based on the accuracy or completeness of the contents of this document and reserves the right to make changes to specifications and product descriptions at any time without notice. Taoglas reserves all rights to this document and the information contained herein. Reproduction, use or disclosure to third parties without express permission is strictly prohibited. Copyright © Taoglas Ltd.



1. Introduction



The Taoglas GuardianX MA9908.A.002.wm is a low profile heavy duty, fully IP67 waterproof external antenna. Combining 8 elements into one antenna, 1 GPS/GLONASS/Galileo, 4* LTE MIMO (600MHz to 6GHz) and 3* Dual-band Wi-Fi MIMO 2.4-5.8GHz.

Typical applications include:

- Passenger Bus / Rail / Air Applications.
- Automotive and Heavy Equipment Vehicle Tracking and Telematics
- Remote Asset and Pipeline Monitoring
- HD Video over LTE
- First Responder and Emergency Services
- M2M Applications/IoT

LTE 4G applications demand high speed data uplink and downlink. High efficiency and high gain MIMO antennas are necessary to achieve the required signal to noise ratio and throughput required to solve these challenges. Taoglas also takes care to have high isolation between the two MIMO antennas to prevent self-interference. Low loss cables are used to keep efficiency high over long cable lengths. In contrast, smaller MIMO antennas with poorer quality thinner cables will have much reduced efficiency and isolation, which would lead to a large drop in system throughput, increased number of drops, and may indeed not make a system connection at all.

Cable length and connector types are customizable. Contact your regional Taoglas customer support team for installation guidelines or further information.

2. Specifications

GNSS Frequency Bands Covered							
GPS/QZSS	L1 1575.42MHz	L2 1227.6MHz	L5 1176.45MHz	L6 1278.75MHz			
	■	□	□	□			
GLONASS	L5R 1176.45MHz	L3PT 1201.5MHz	L2PT 1246MHz	L1CR 1575.42MHz	L1PT 1602MHz		
	□	□	□	■	■		
Galileo	E5a 1176.45MHz	E5b 1201.5MHz	E4 1215MHz	E3 1256MHz	E6 1278.75MHz	E2 1561MHz	L1 1575.42MHz
	□	□	□	□	□	□	■
BeiDou	B1 1561MHz	B2 1207.14MHz	B3 1268.52MHz				
	□	□	□				
Compass	E5B(B2)/ E6(B3) 1268.56MHz	E2(B1) 1561MHz					
	□	□					
SBAS	Omnistar 1542.5MHz	WAAS/EGN OS 1575.42MHz					
	□	■					

GNSS Electrical		
Frequency (MHz)	1575.42	1602
VSWR (max.)	2.0:1	2.0:1
Passive Antenna Efficiency (%) (Without cable loss)	67	71
Passive Antenna Gain at Zenith (dBic) (Without cable loss)	1.5	0
Axial Ratio (dB)	6	14
Polarization	RHCP	
Impedance	50Ω	
Cable	RG-174	
Connector	SMA(M)	

LNA and Filter Electrical Properties

Frequency (MHz)	1575.42	1602
VSWR (max.)	2.0:1	2.0:1
Gain@1.8V (dBic)	25	25
Gain@3.0V (dBic)	31	31
Gain@5.5V (dBic)	34	34
Noise@1.8V (dB)	3	3
Noise@3.0V (dB)	3	3
Noise@5.5V (dB)	3.3	3.3
Power consumption@1.8V (mA)	5	
Power consumption@3.0V (mA)	10	
Power consumption@5.5V (mA)	23	

Total Specification (Through Antenna, SAW Filter and LNA)

Frequency (MHz)	1575.42	1602
Gain@3V (dBic)	31 ± 3	30 ± 3
Output Impedance	50 Ω	

LTE Antenna											
Frequency (MHz)		5G NR Band 71	LTE700	GSM 850/900	5G NR Band	DCS	PCS	UMTS1	LTE2600	5G NR Band 77, 78	LTE5200/Wi-Fi 5800
		617 ~698	698 ~824	824 ~960	1427~ 1518	1710 ~1880	1850 ~1990	1920 ~2170	2300 ~2690	3300 ~3800	5150 ~5925
Efficiency (%)											
MIMO 1	1m	53.81	55.84	54.90	82.93	65.97	56.44	54.58	53.00	36.06	55.55
MIMO 2	1m	36.81	62.84	52.98	52.48	81.76	68.11	62.85	50.79	39.94	46.69
MIMO 3	1m	38.76	67.44	54.38	56.51	79.93	71.07	65.48	50.44	34.06	50.07
MIMO 4	1m	52.17	50.57	55.14	77.95	77.05	55.01	56.91	62.88	26.87	55.11
Average Gain (dB)											
MIMO 1	1m	-2.69	-2.53	-2.60	-0.81	-1.81	-2.48	-2.63	-2.76	-4.43	-2.55
MIMO 2	1m	-4.34	-2.02	-2.76	-2.80	-0.87	-1.67	-2.02	-2.94	-3.99	-3.31
MIMO 3	1m	-4.12	-1.71	-2.65	-2.48	-0.97	-1.48	-1.84	-2.97	-4.68	-3.00
MIMO 4	1m	-2.83	-2.96	-2.59	-1.08	-1.13	-2.60	-2.45	-2.01	-5.71	-2.59
Peak Gain (dBi)											
MIMO 1	1m	2.71	2.27	3.51	3.84	3.87	4.07	5.20	5.10	2.44	3.84
MIMO 2	1m	1.27	1.91	1.66	3.72	4.69	3.14	3.64	3.96	3.05	5.97
MIMO 3	1m	0.70	2.78	1.68	3.24	4.10	3.58	3.58	4.98	3.03	5.66
MIMO 4	1m	3.61	3.30	3.45	3.51	4.63	3.14	3.41	4.83	1.79	5.45
Impedance		50 Ω									
Polarization		Linear									
Radiation Pattern		Omni									
Max. input power		2W									

Wi-Fi MIMO			
Frequency (MHz)		2400~2500	5150~5850
Efficiency (%)			
MIMO1	1m	71.50	59.78
MIMO2	1m	79.81	59.22
MIMO3	1m	79.96	59.13
Average Gain (dB)			
MIMO1	1m	-1.46	-2.23
MIMO2	1m	-0.98	-2.28
MIMO3	1m	-0.97	-2.28
Peak Gain (dBi)			
MIMO1	1m	4.08	3.47
MIMO2	1m	4.53	4.47
MIMO3	1m	4.89	5.71
Impedance		50 Ω	
Polarization		Linear	
Radiation Pattern		Omni	
Max. input power		2W	

Mechanical	
Height	16.5mm
Planner Dimension	360mm * 160mm
Casing	Material
Cable	1M TGC-200 for LTE/Wi-Fi – Fully Customizable 1M RG-174 for GNSS – Fully Customizable
Connector	LTE: SMA-Plug – Fully Customizable Wi-Fi: RP-SMA-Plug – Fully Customizable GNSS: SMA-Plug – Fully Customizable
Sealant	Rubber Stopper
Cable Pull	RG-174 4Kg / TGC-200 9Kg
Weight	750 g (Not Included Cable and Package)
Environmental	
Protection	IP67
Temperature Range	-40°C to 85°C
Humidity	Non-condensing 65°C 95% RH

LTE/5G NR Bands			
Band Number	5G NR/FR1/LTE / LTE-Advanced / WCDMA / HSPA / HSPA+ / TD-SCDMA		
	Uplink	Downlink	Covered
1	UL: 1920 to 1980	DL: 2110 to 2170	✓
2	UL: 1850 to 1910	DL: 1930 to 1990	✓
3	UL: 1710 to 1785	DL: 1805 to 1880	✓
4	UL: 1710 to 1755	DL: 2110 to 2155	✓
5	UL: 824 to 849	DL: 869 to 894	✓
7	UL: 2500 to 2570	DL: 2620 to 2690	✓
8	UL: 880 to 915	DL: 925 to 960	✓
9	UL: 1749.9 to 1784.9	DL: 1844.9 to 1879.9	✓
11	UL: 1427.9 to 1447.9	DL: 1475.9 to 1495.9	✓
12	UL: 699 to 716	DL: 729 to 746	✓
13	UL: 777 to 787	DL: 746 to 756	✓
14	UL: 788 to 798	DL: 758 to 768	✓
17	UL: 704 to 716	DL: 734 to 746 (LTE only)	✓
18	UL: 815 to 830	DL: 860 to 875 (LTE only)	✓
19	UL: 830 to 845	DL: 875 to 890	✓
20	UL: 832 to 862	DL: 791 to 821	✓
21	UL: 1447.9 to 1462.9	DL: 1495.9 to 1510.9	✓
22	UL: 3410 to 3490	DL: 3510 to 3590	✓
23	UL: 2000 to 2020	DL: 2180 to 2200 (LTE only)	✓
24	UL: 1625.5 to 1660.5	DL: 1525 to 1559 (LTE only)	✓
25	UL: 1850 to 1915	DL: 1930 to 1995	✓
26	UL: 814 to 849	DL: 859 to 894	✓
27	UL: 807 to 824	DL: 852 to 869 (LTE only)	✓
28	UL: 703 to 748	DL: 758 to 803 (LTE only)	✓
29	UL: -	DL: 717 to 728 (LTE only)	✓
30	UL: 2305 to 2315	DL: 2350 to 2360 (LTE only)	✓
31	UL: 452.5 to 457.5	DL: 462.5 to 467.5 (LTE only)	✗
32	UL: -	DL: 1452 to 1496	✓
35		1850 to 1910	✓
38		2570 to 2620	✓
39		1880 to 1920	✓
40		2300 to 2400	✓
41		2496 to 2690	✓
42		3400 to 3600	✓
43		3600 to 3800	✓
48		3550 to 3700	✓
71		617 to 698	✓
74/75/76		1427 to 1518	✓
78		3300 to 3800	✓
79		4400 to 5000	✓

*Covered bands represent an efficiency greater than 20%

3. Active Antenna Characteristics

3.1 Block Diagram (Active antenna)

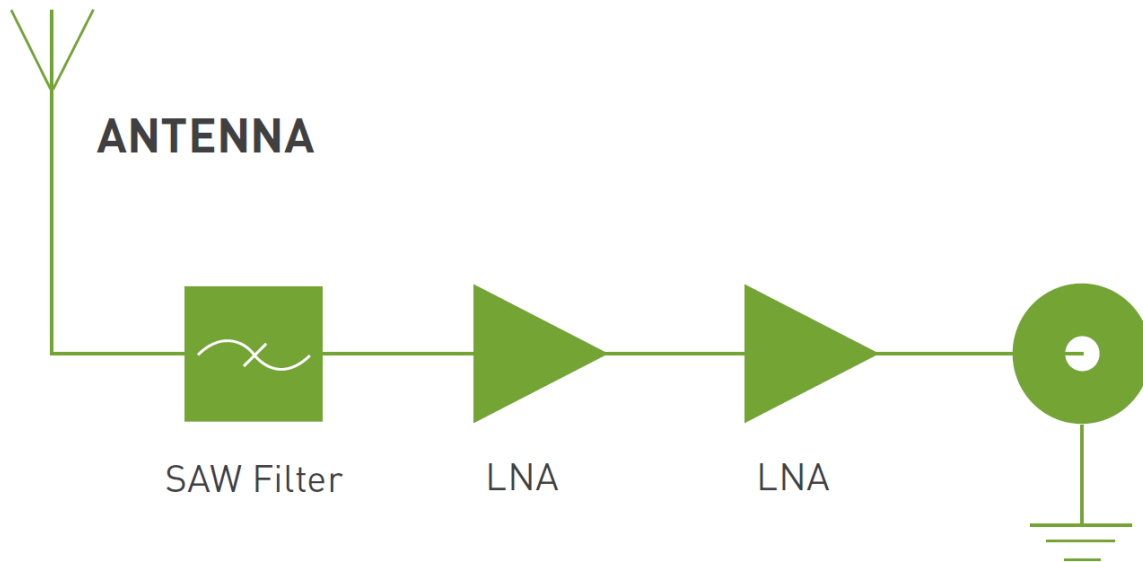

3.2 Passive Antenna Return Loss

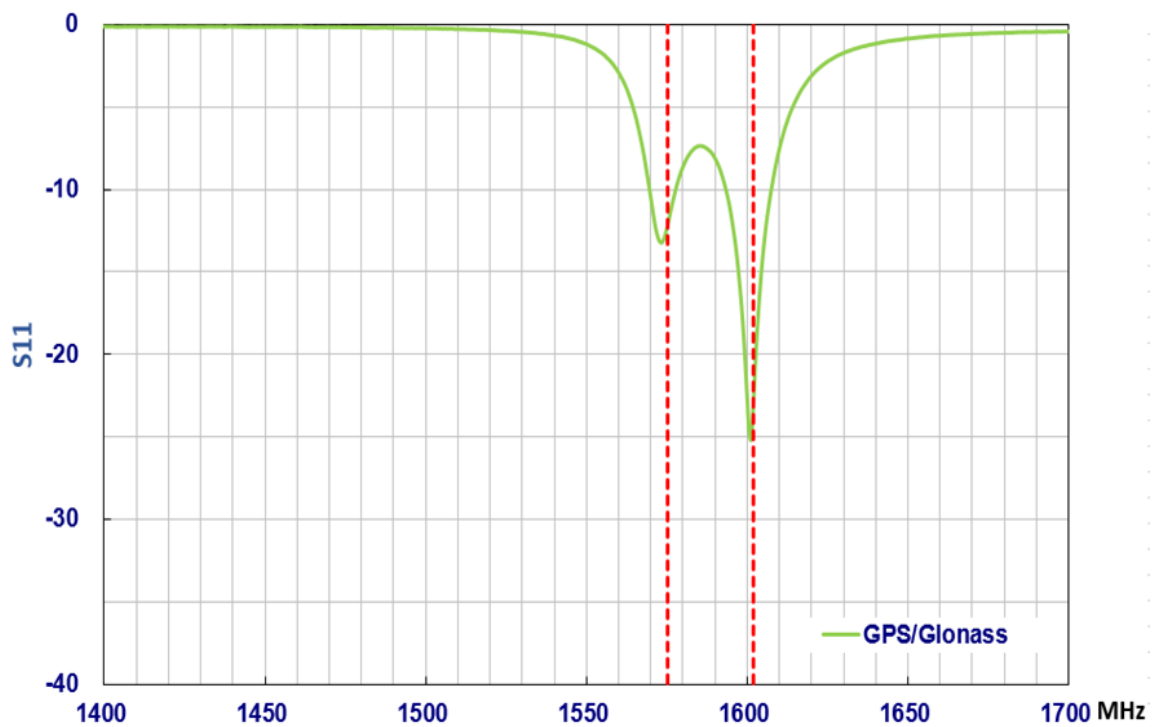

3.3 Passive Antenna Efficiency

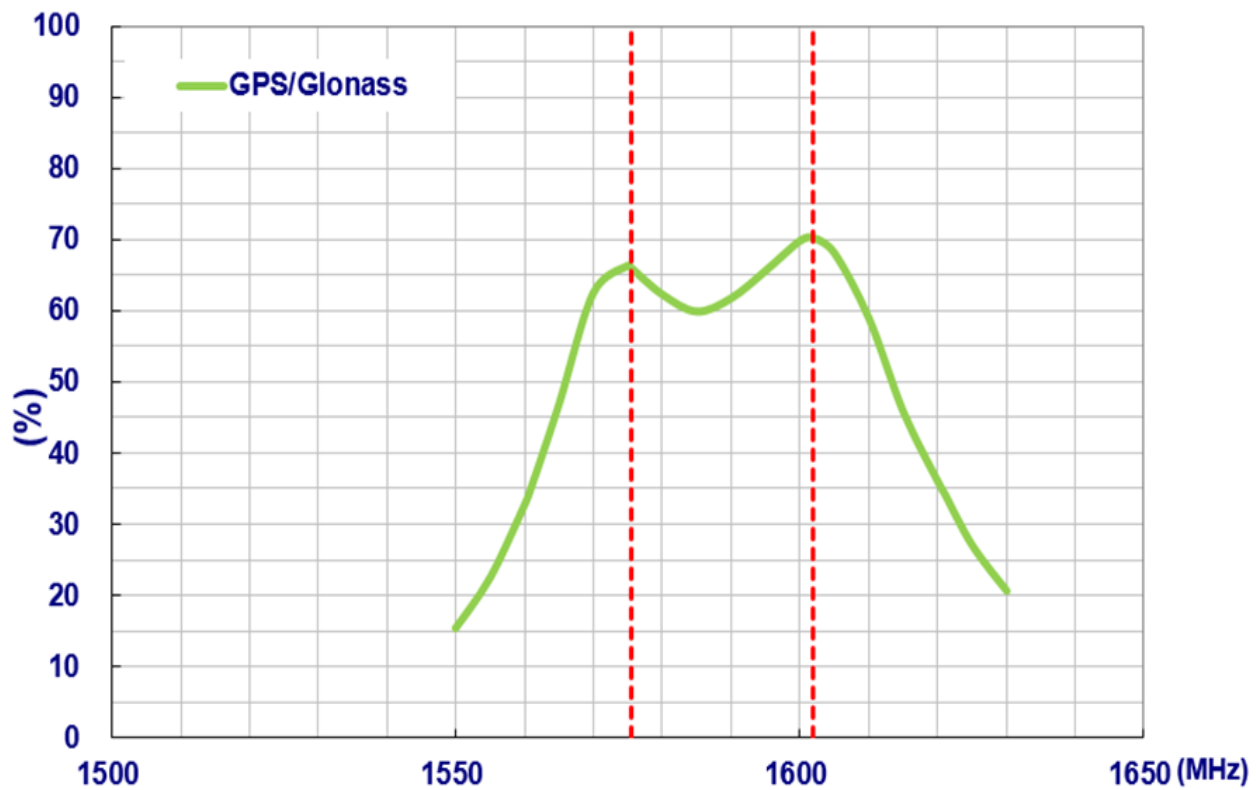

3.4 Passive Antenna Average Gain

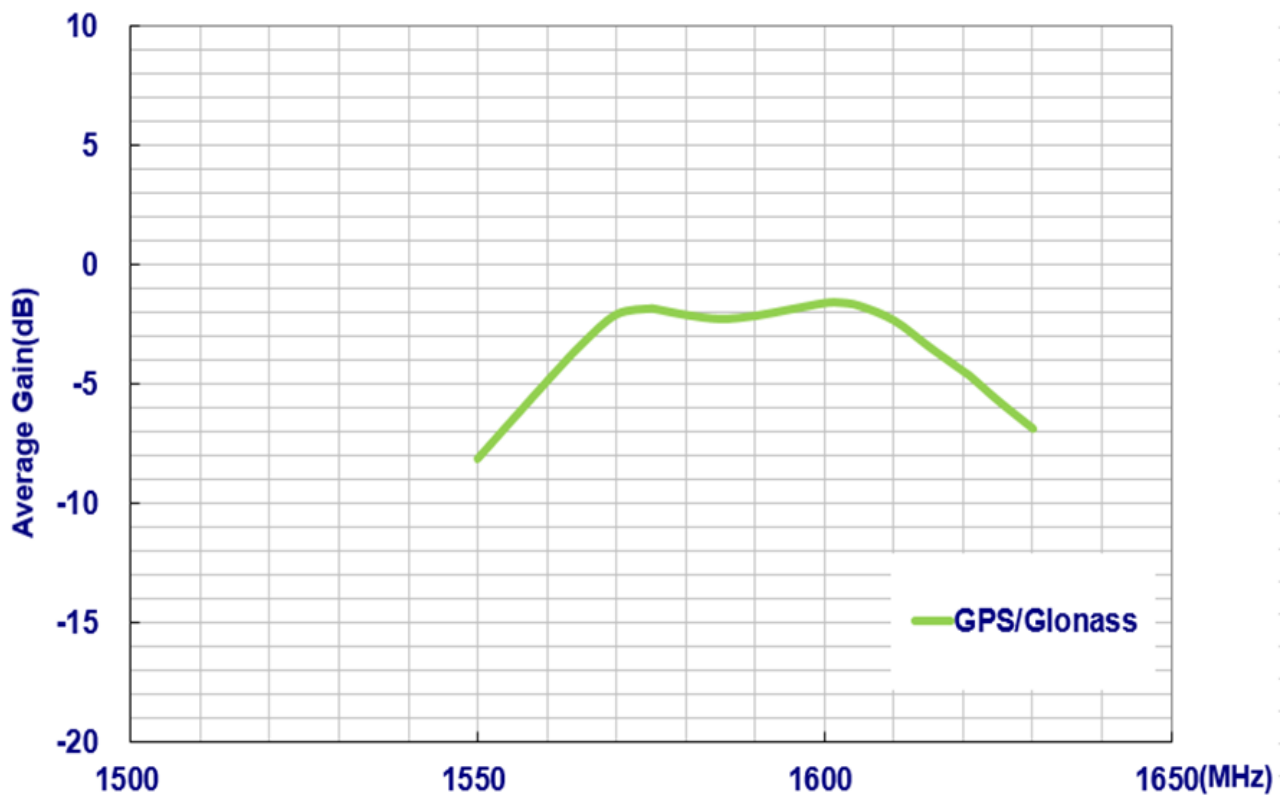

3.5 Passive Antenna Peak Gain

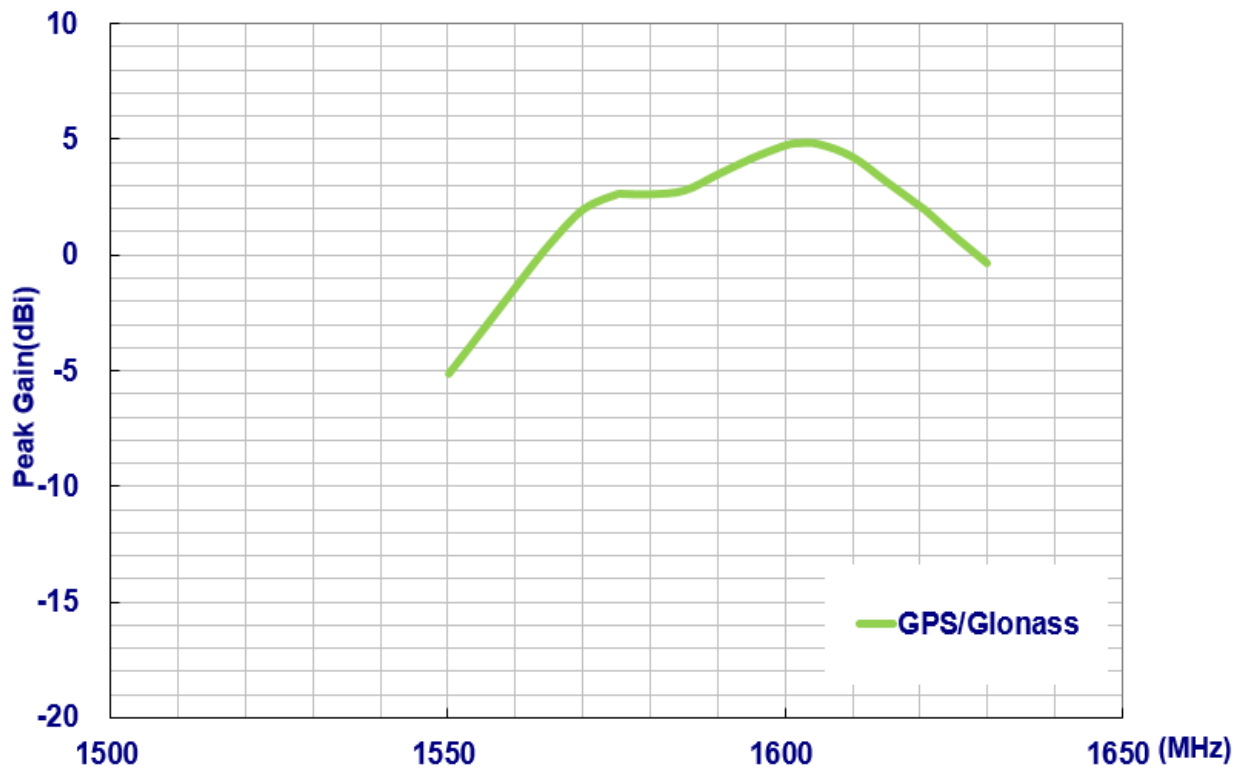

3.6 Passive Antenna Axial Ratio (Zenith is at 0°)

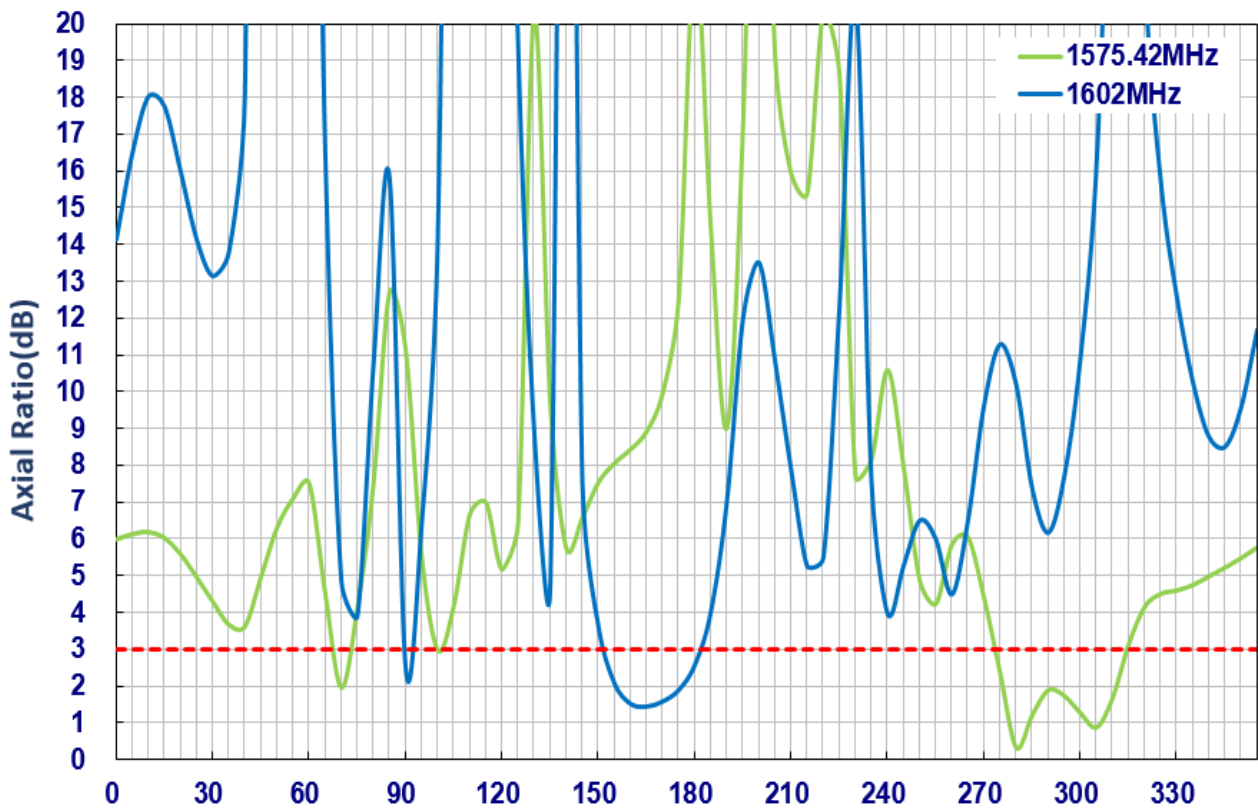

3.7 Active measurements

LNA Gain @ 3.0V

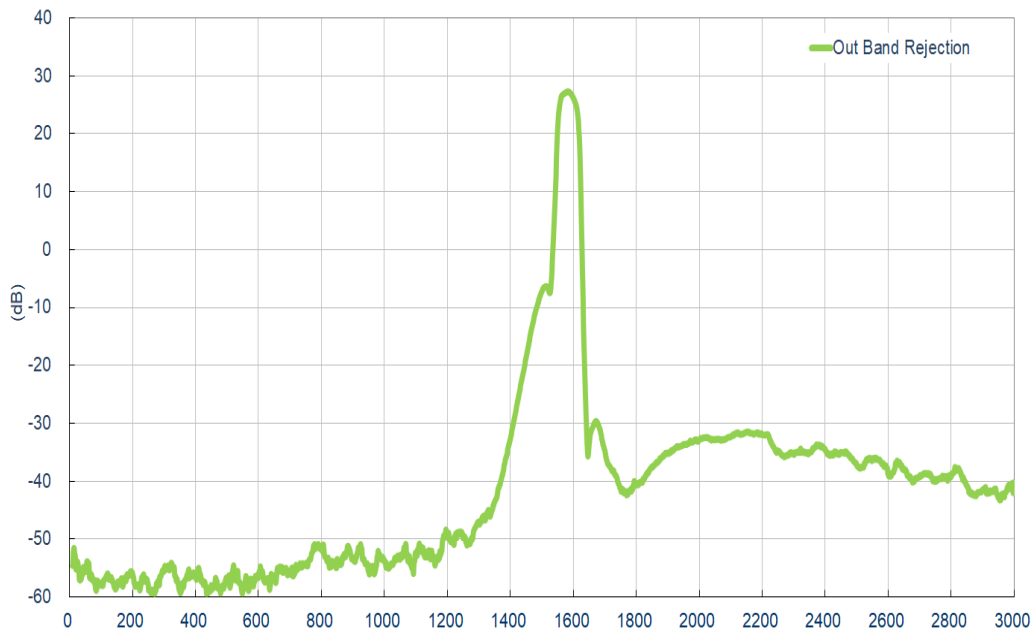

Noise Figure @ 3.0V

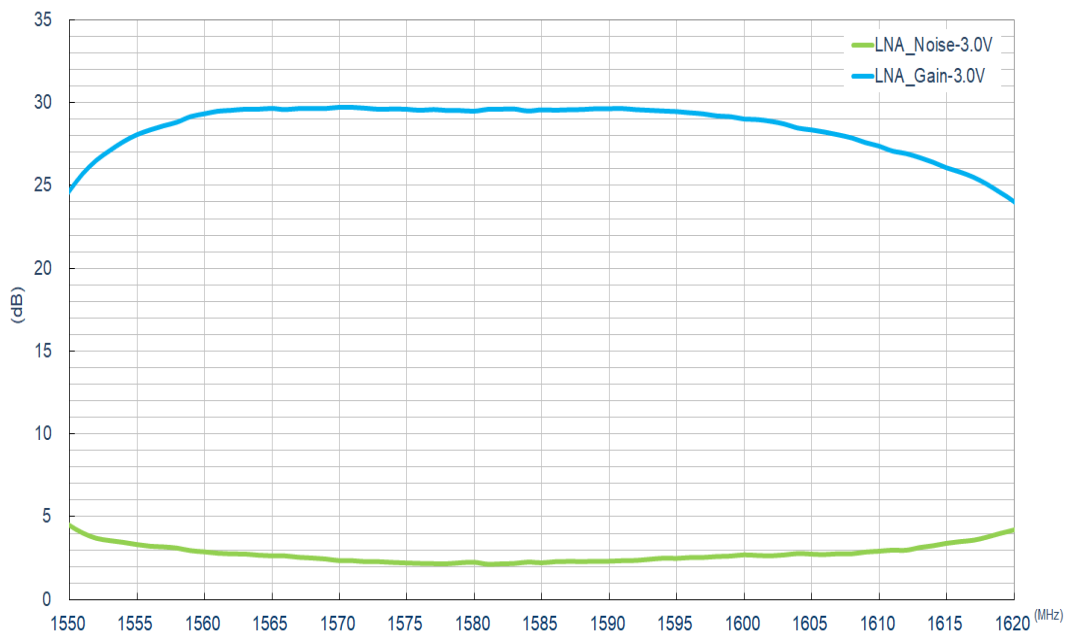

3.8 GNSS Radiation Pattern

1575.42MHz

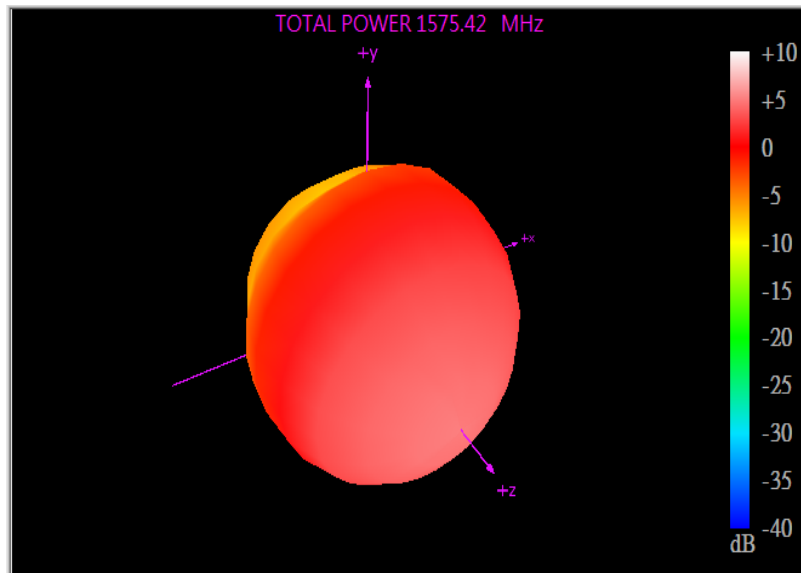

XY Plane	XZ Plane	YZ Plane
----------	----------	----------

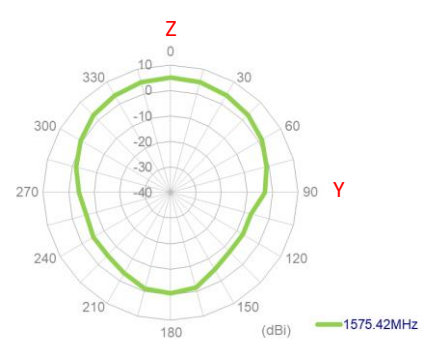
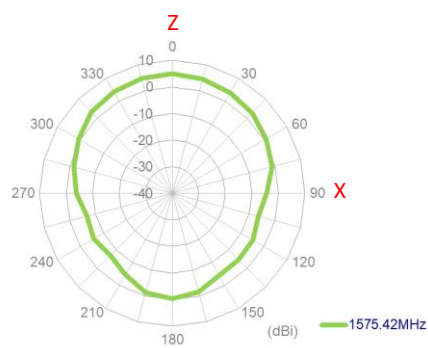
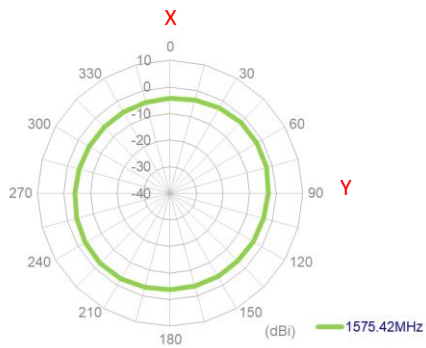

1602MHz

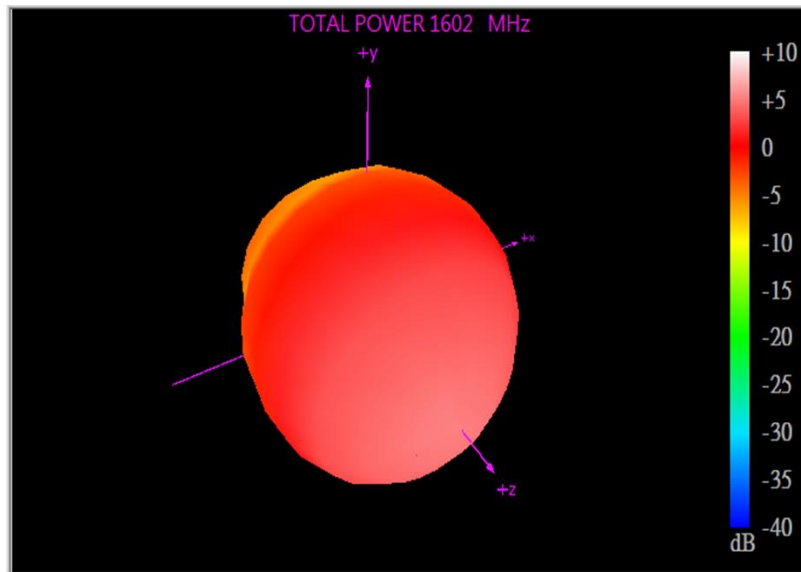

XY Plane XZ Plane YZ Plane

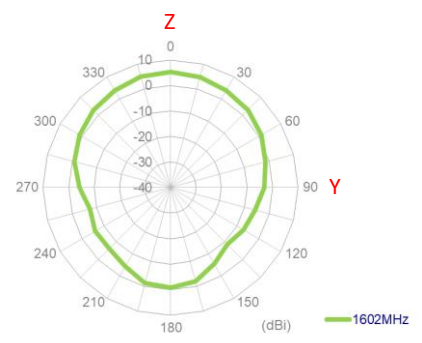
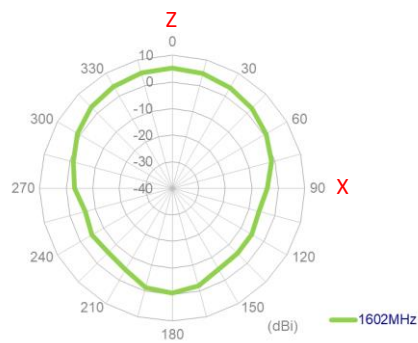
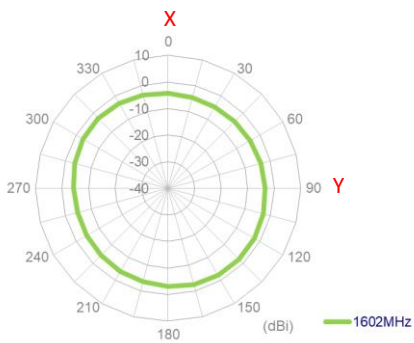

4. Antenna Characteristics

4.1 Return Loss

LTE MIMO

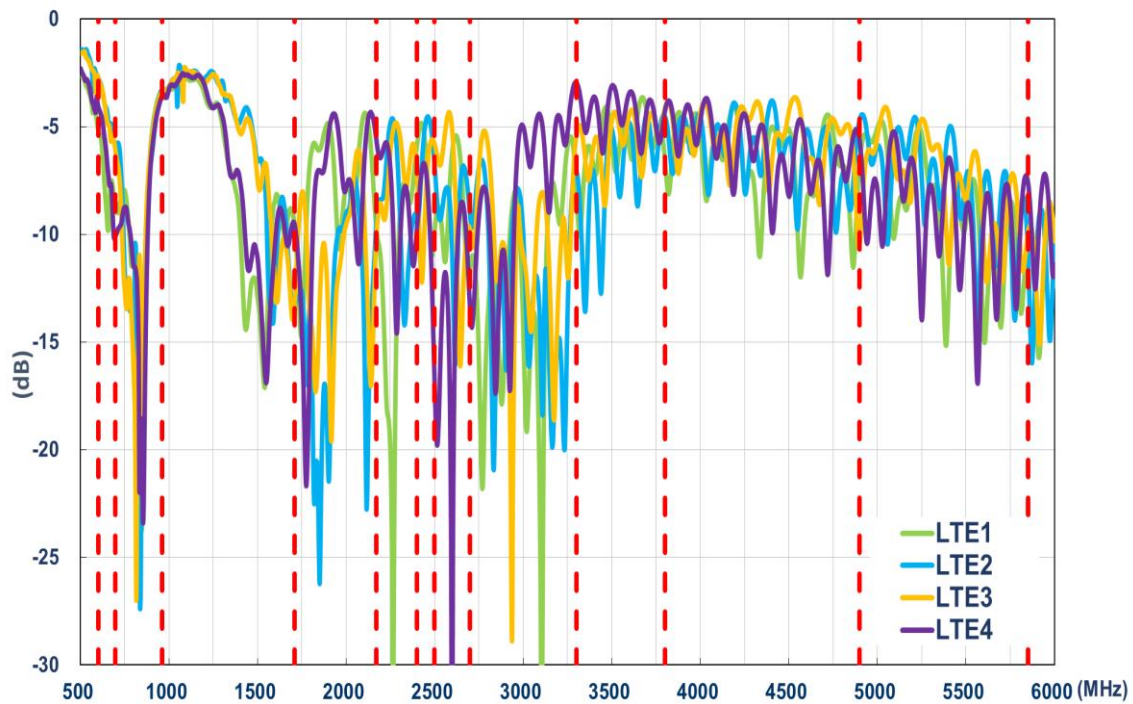

Wi-Fi MIMO

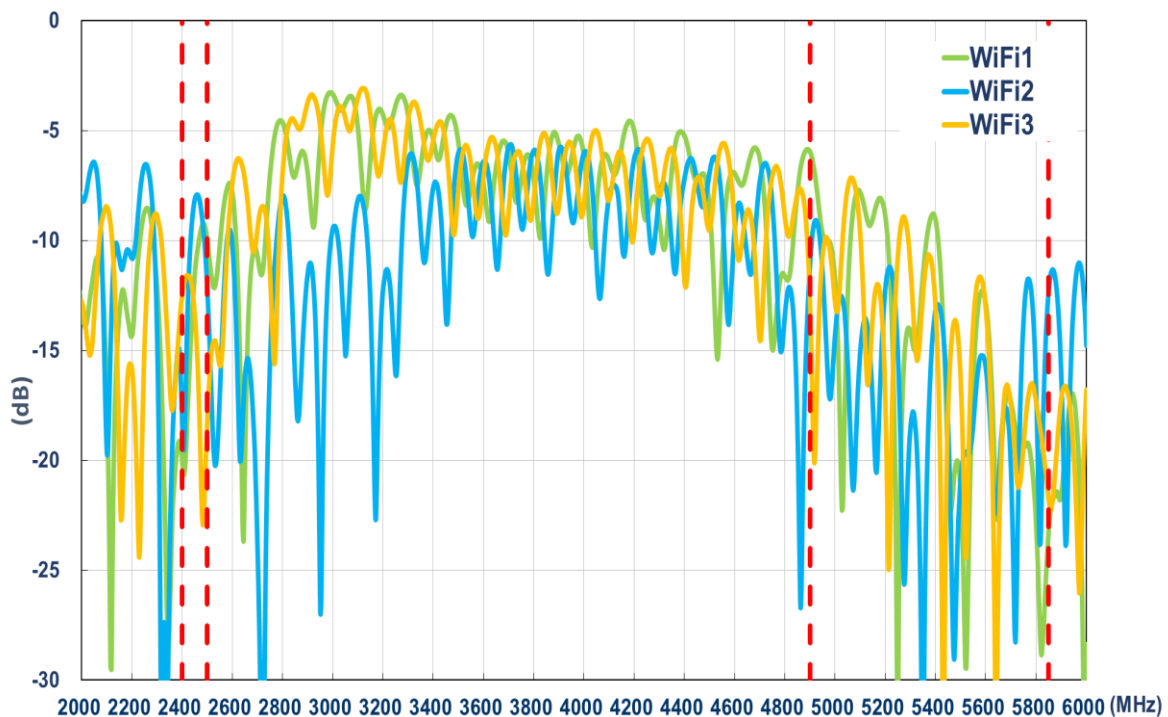

4.2 Isolation

LTE and Wi-Fi MIMO

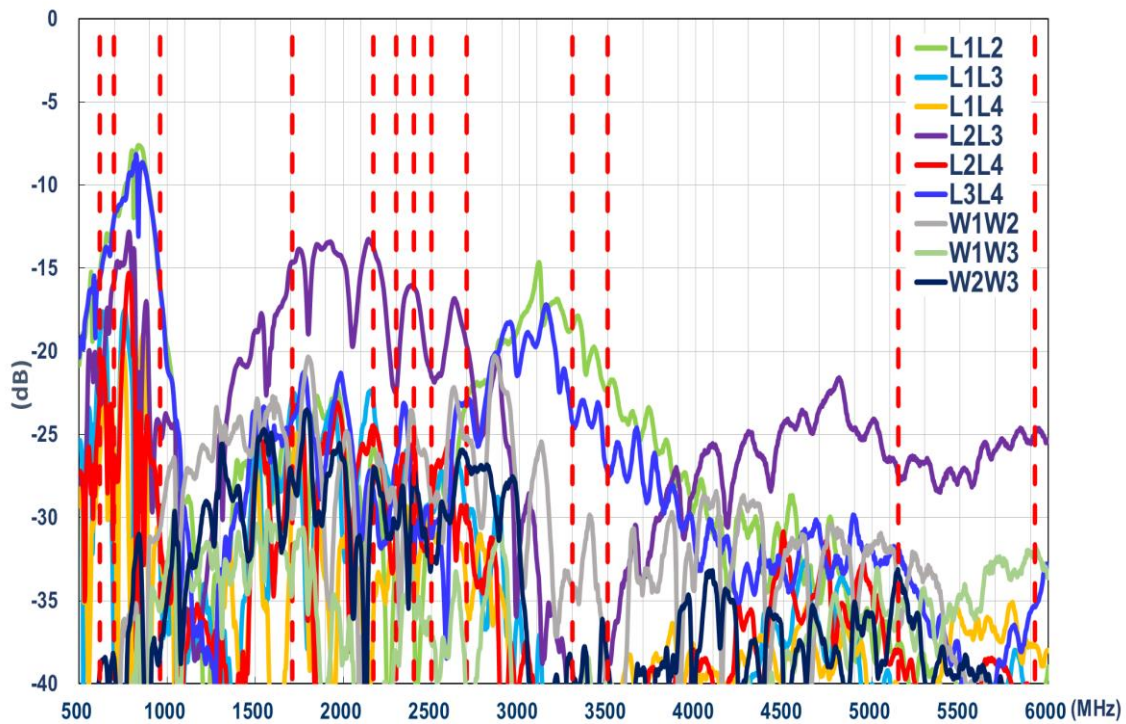

LTE vs Wi-Fi

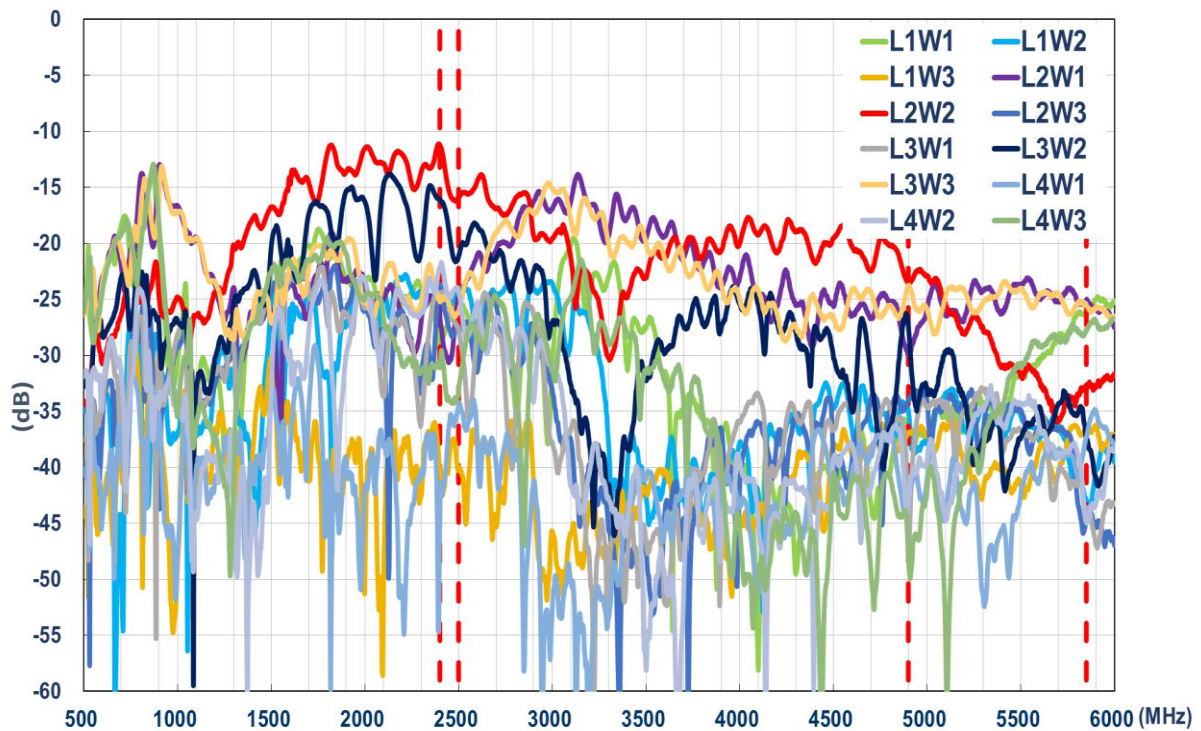

4.3 Efficiency

LTE MIMO

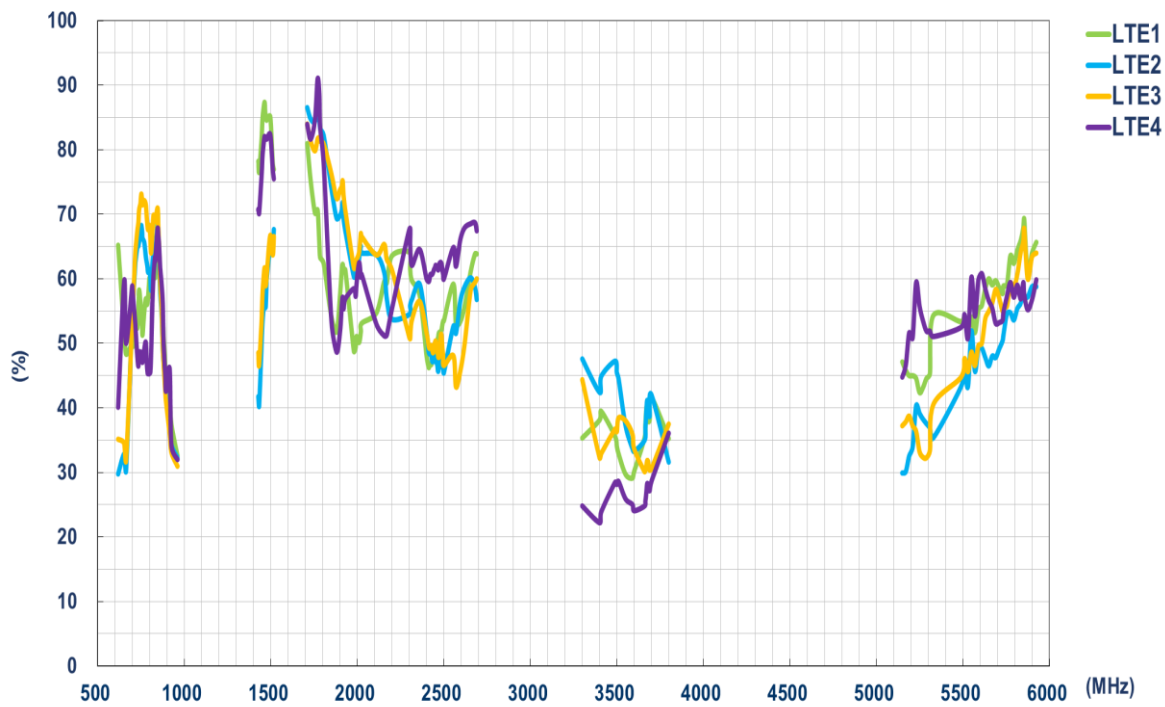

Wi-Fi MIMO

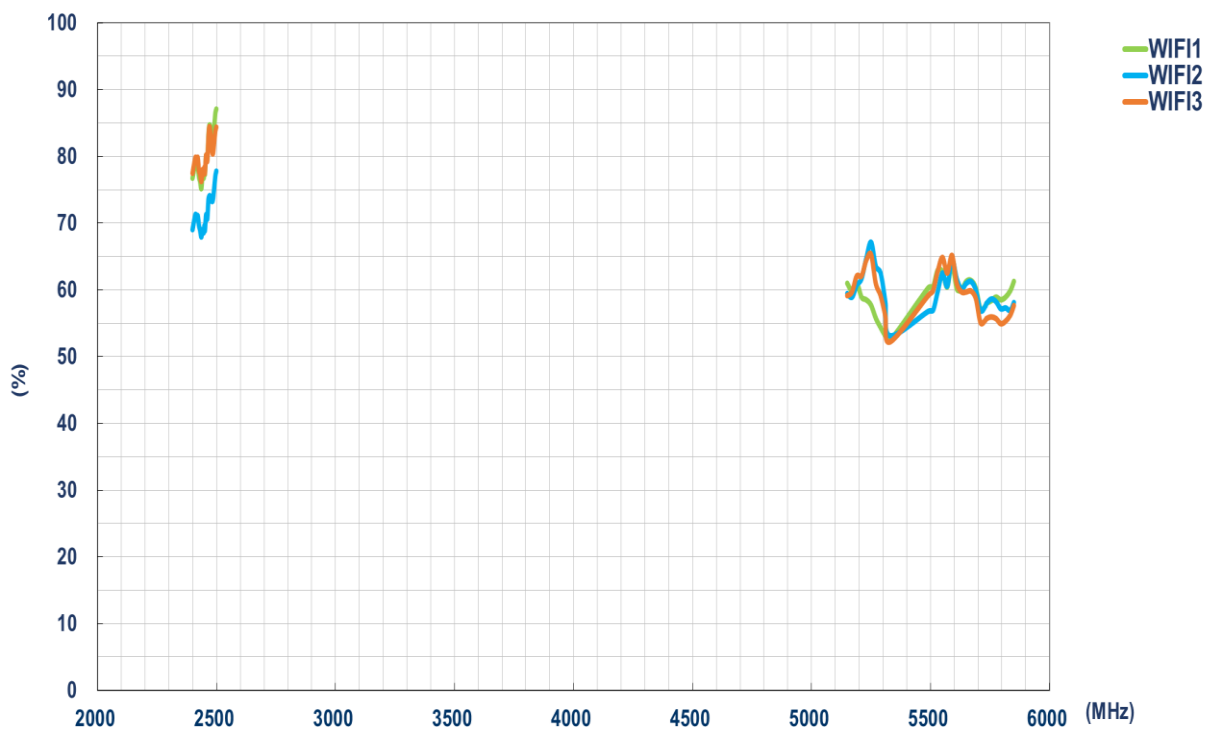

4.4 Average Gain

LTE MIMO

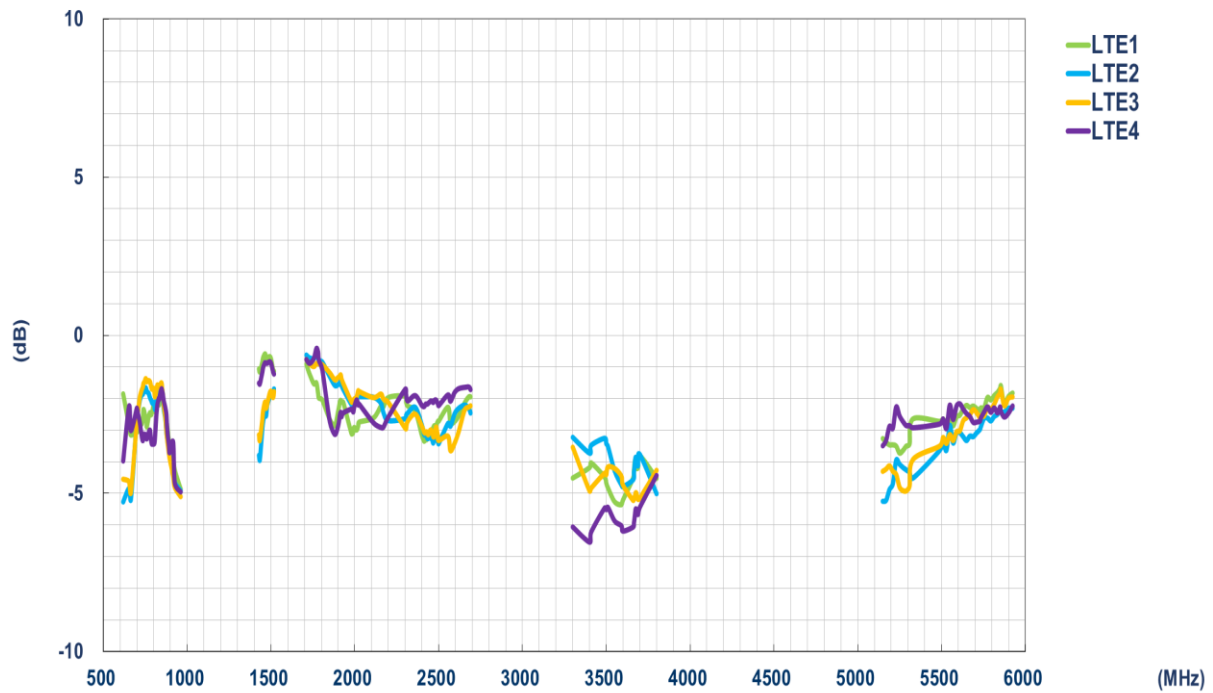

Wi-Fi MIMO

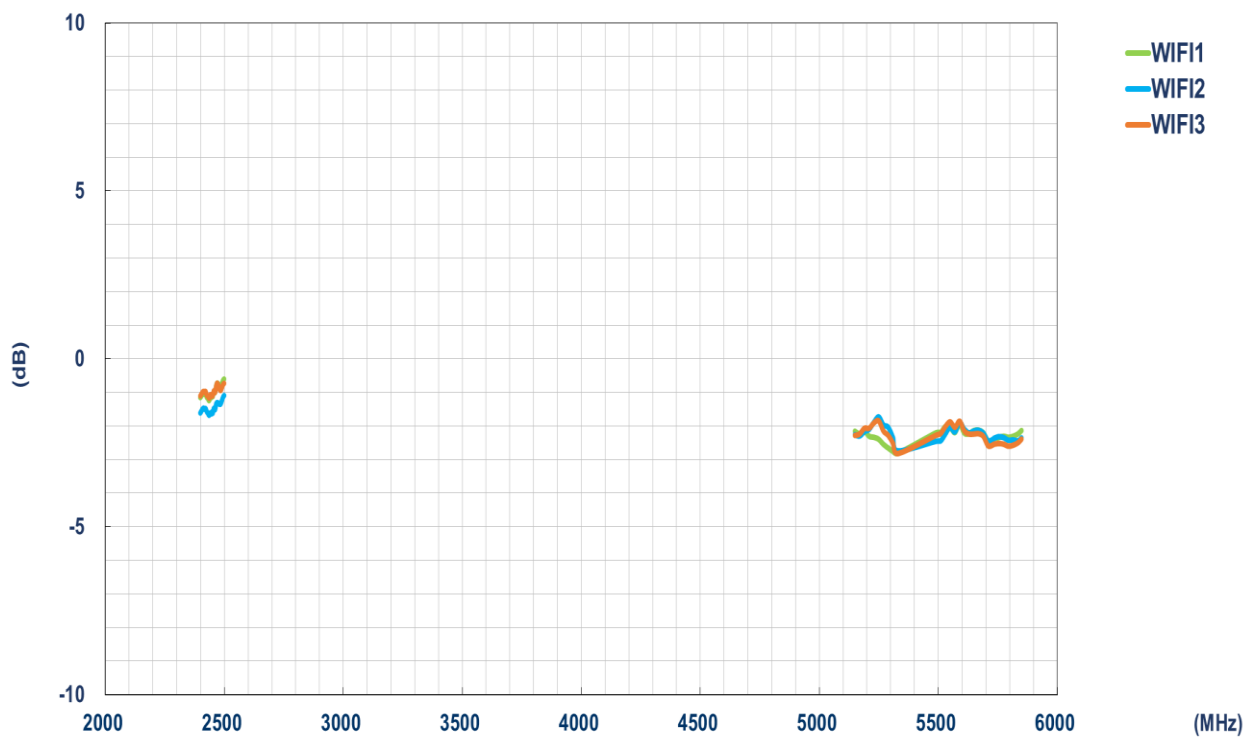

4.5 Peak Gain

LTE MIMO

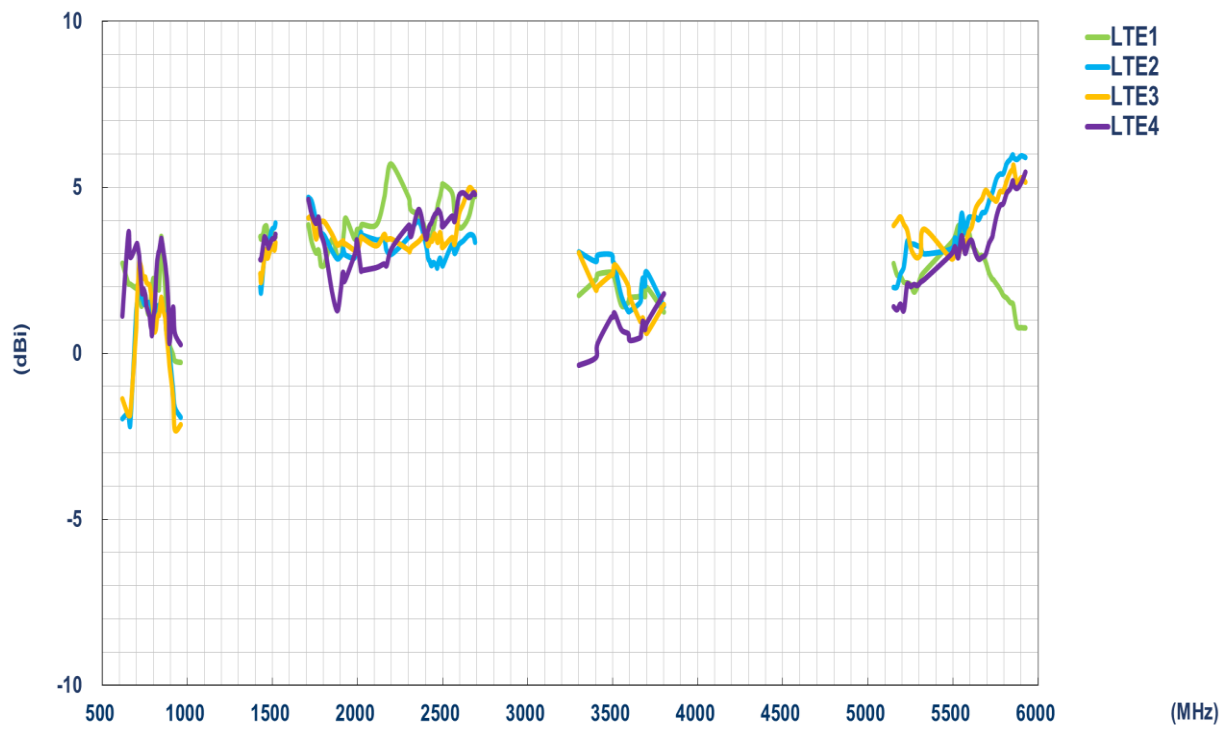

Wi-Fi MIMO

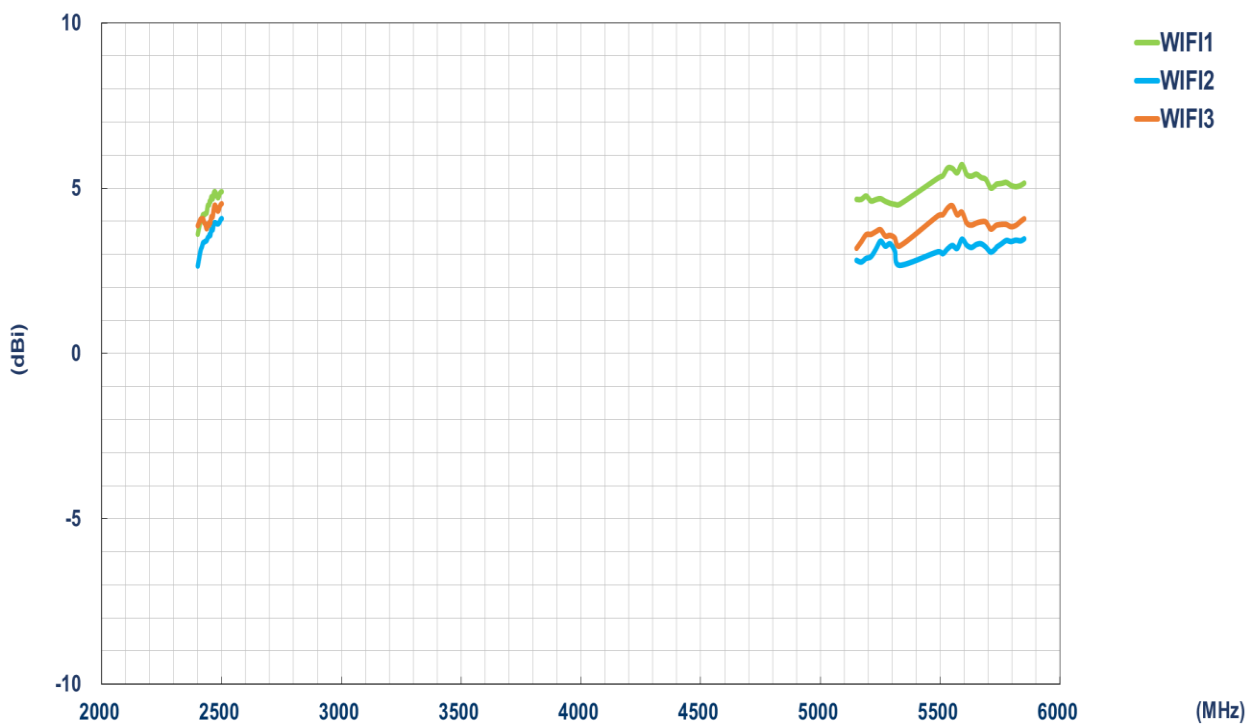

5. Radiation Patterns

5.1 Test Setup

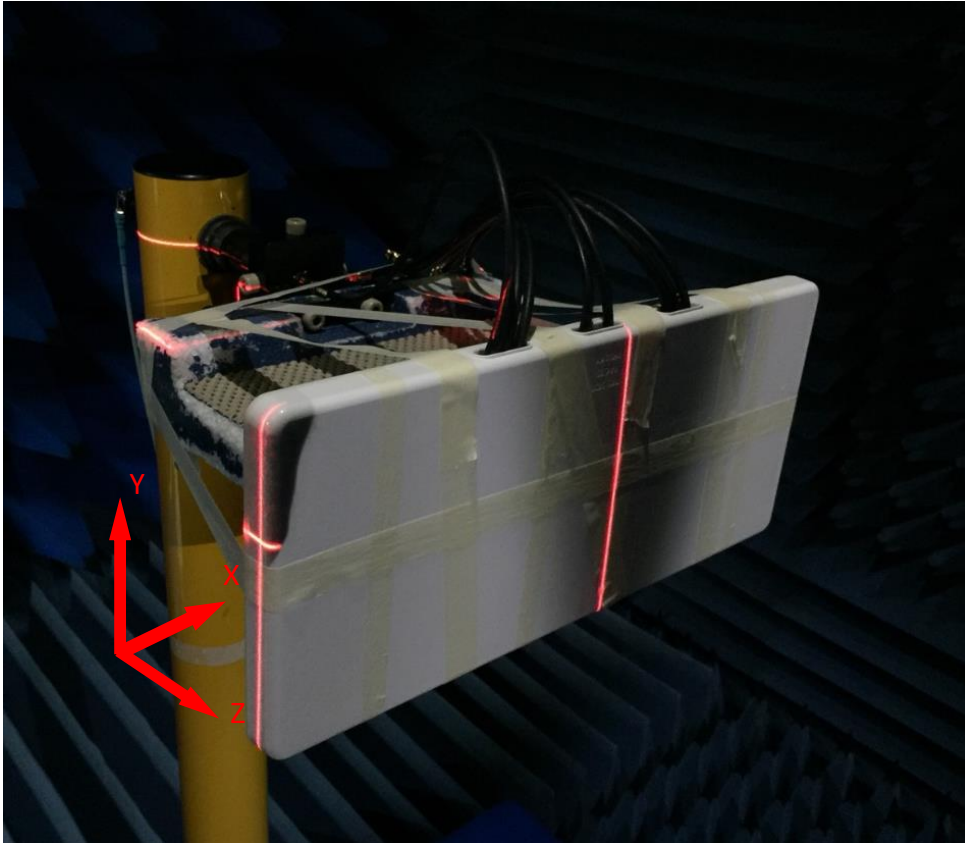

Free space

5.2 LTE MIMO 1 Radiation Pattern

652MHz

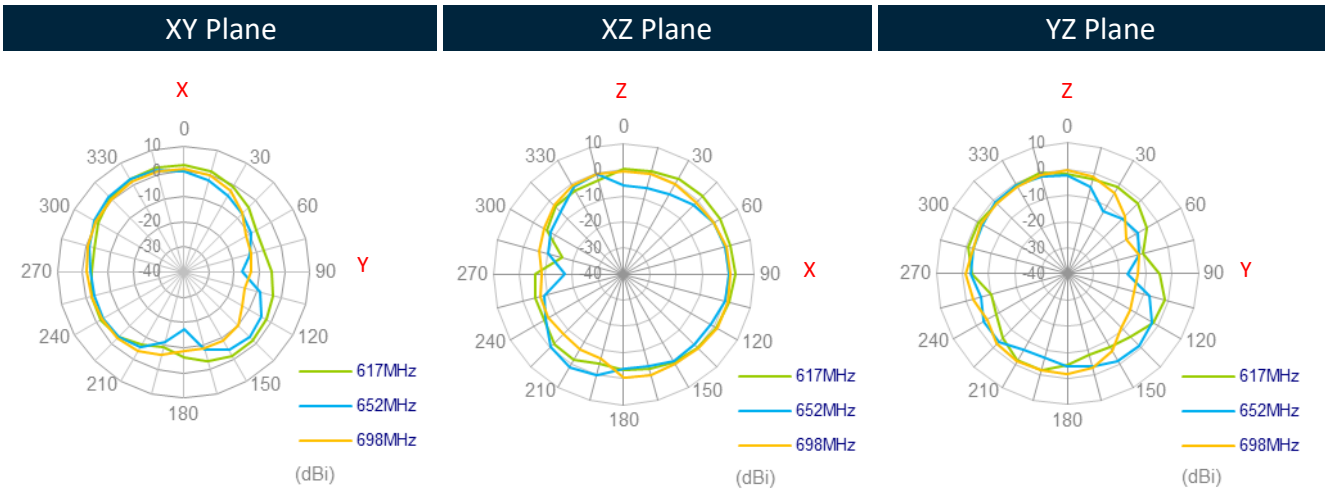
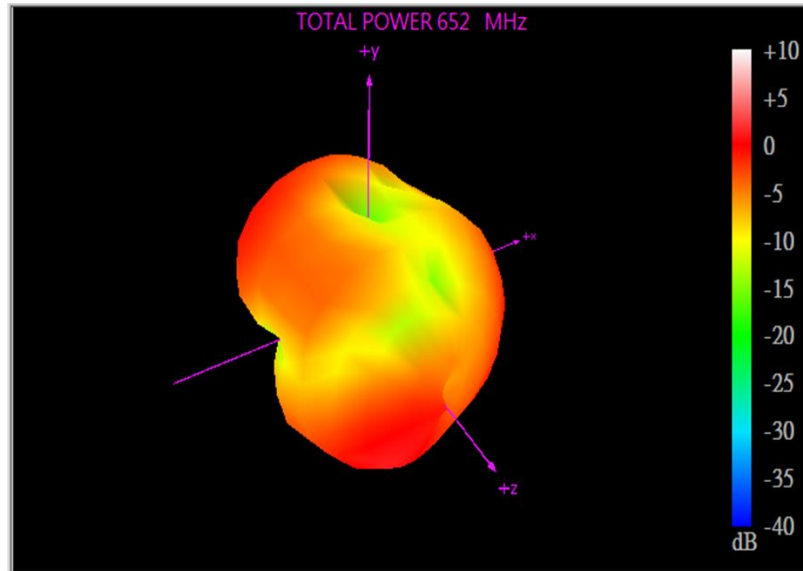

751MHz

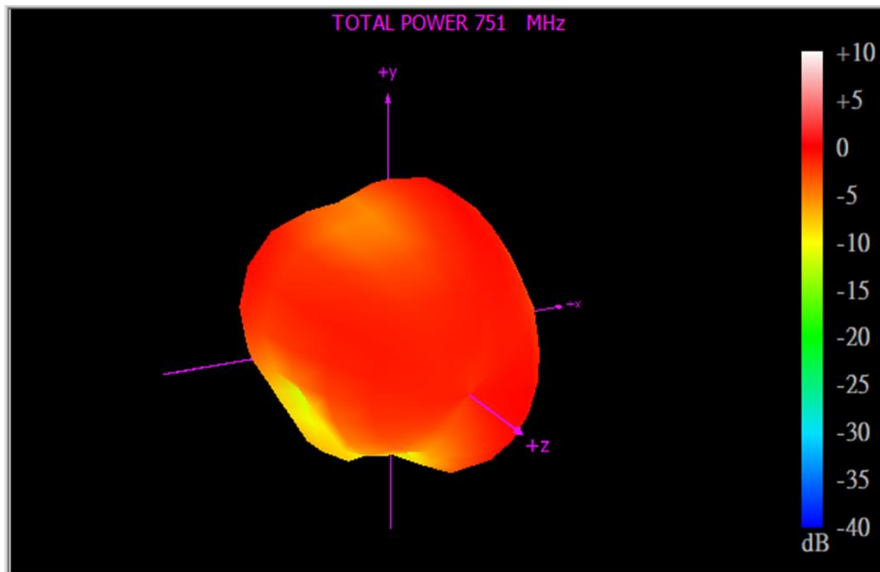

XY Plane

XZ Plane

YZ Plane

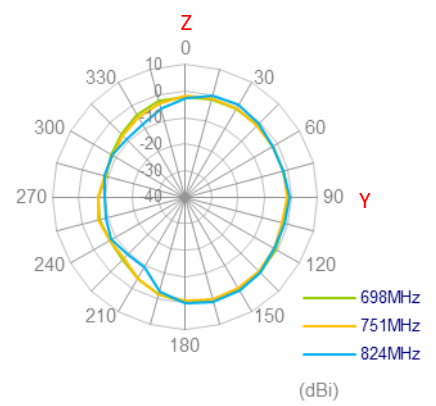
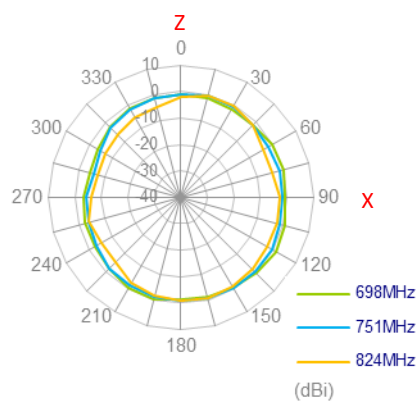
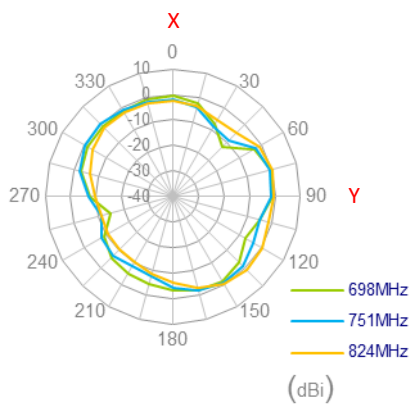

880MHz

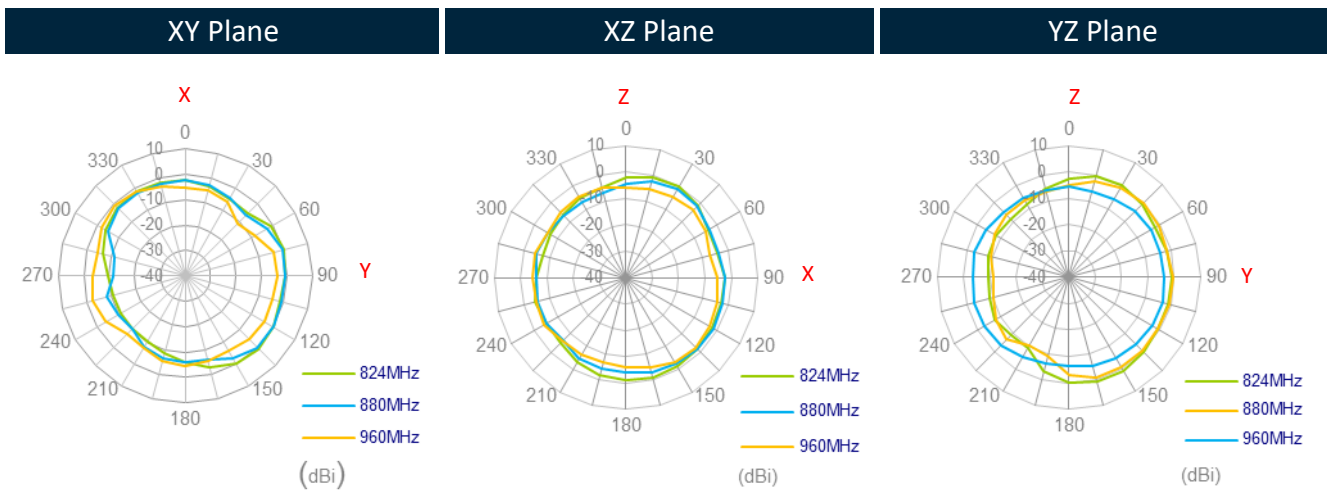
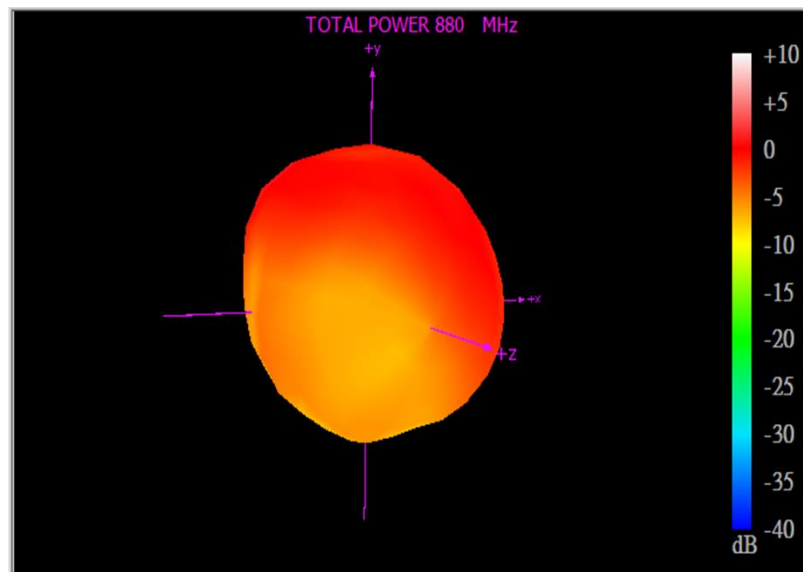

1467MHz

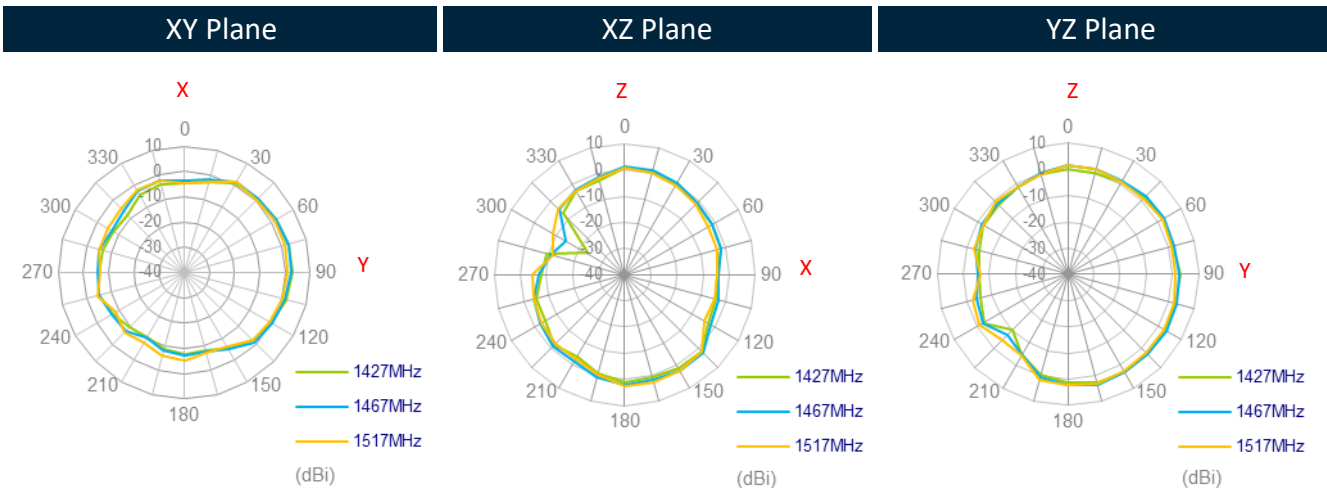
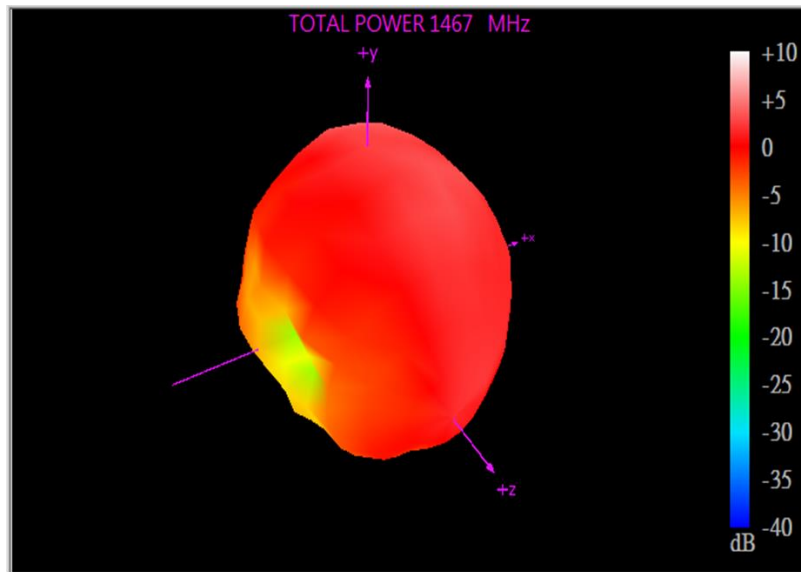

1805MHz

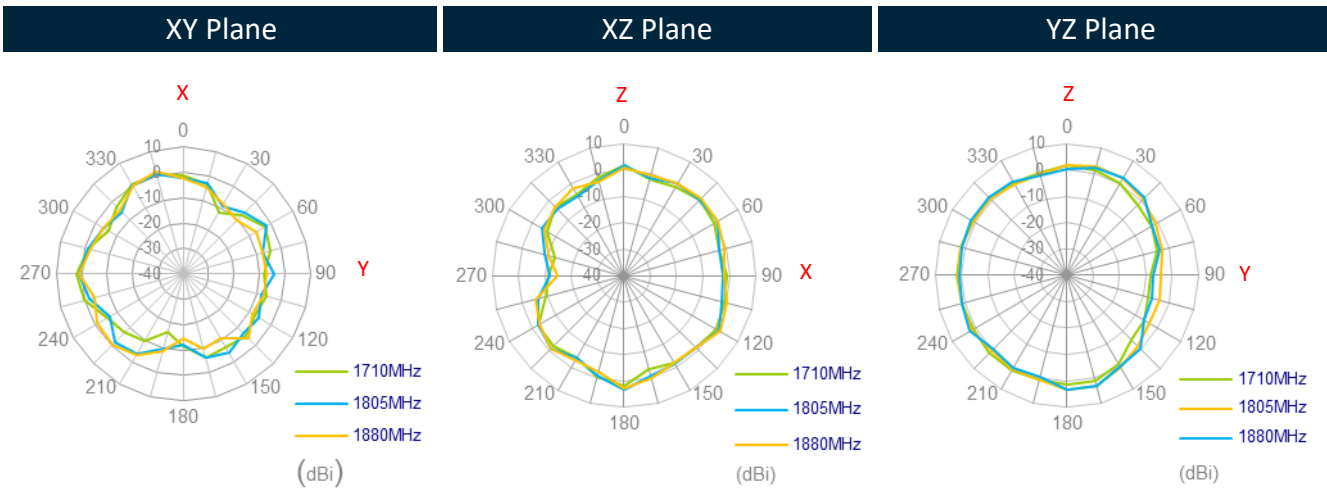
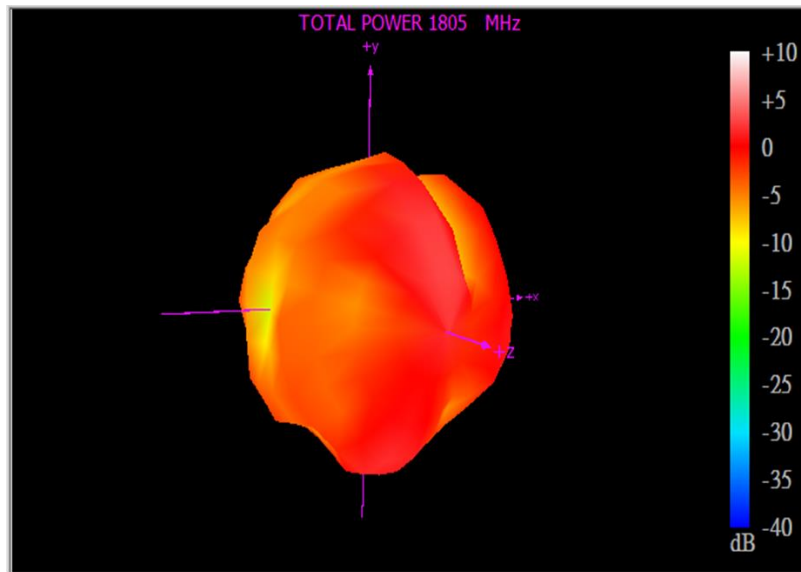

1920MHz

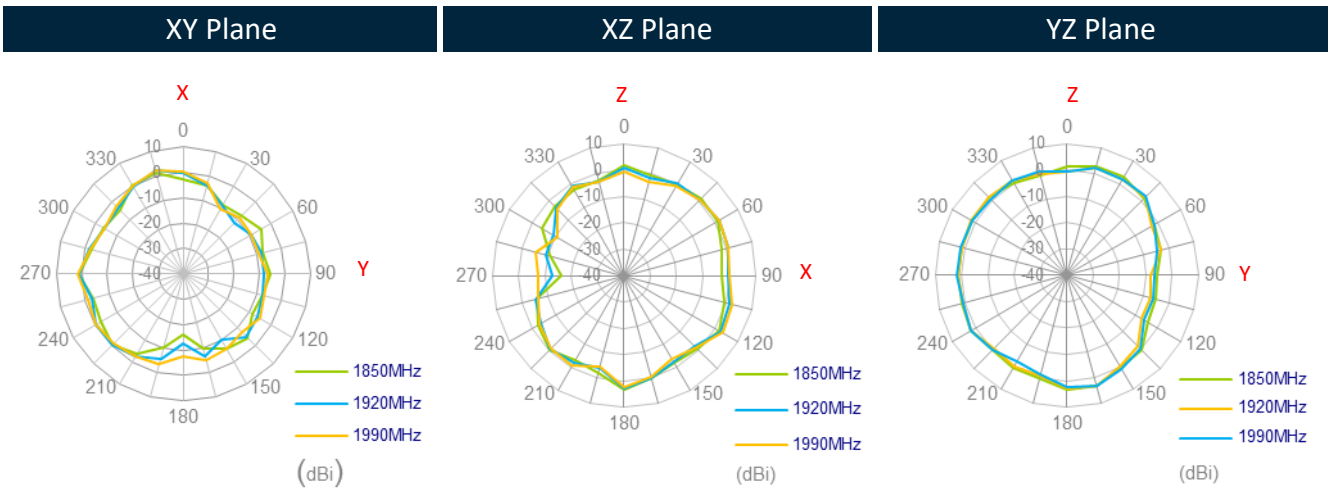
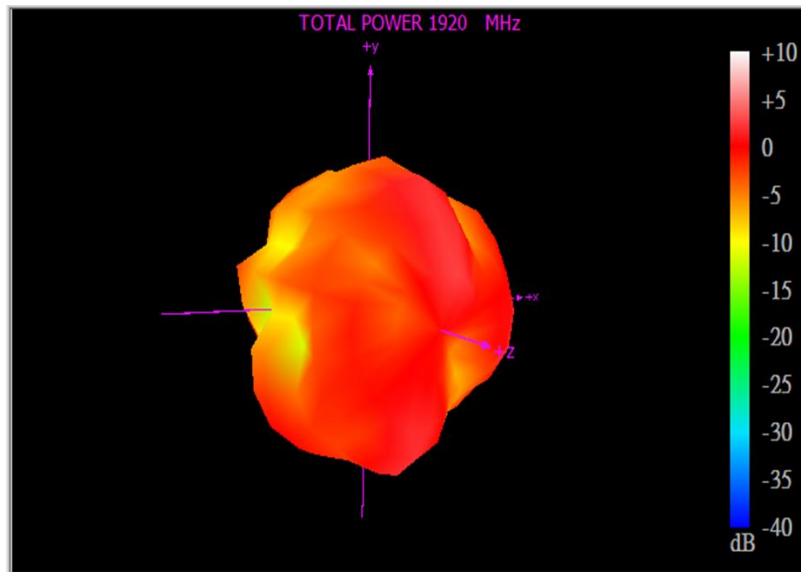

1990MHz

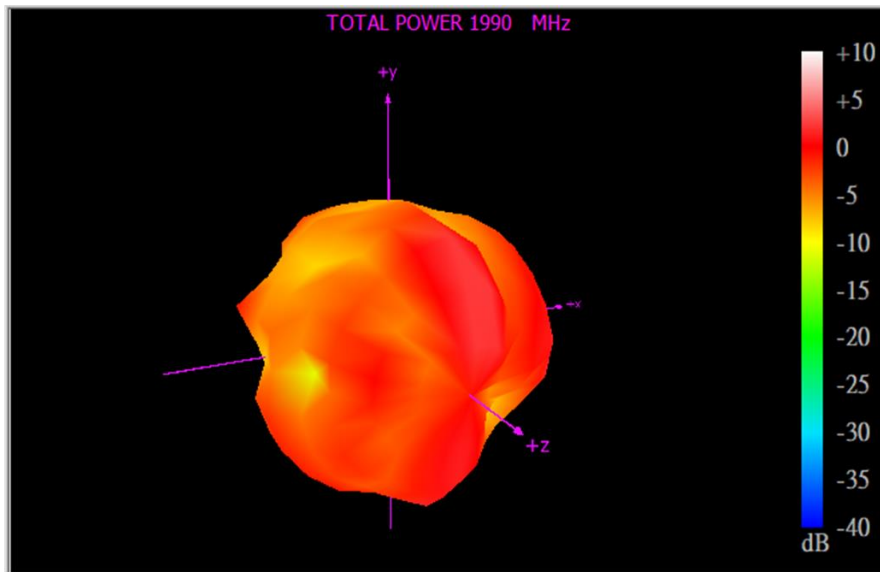

XY Plane XZ Plane YZ Plane

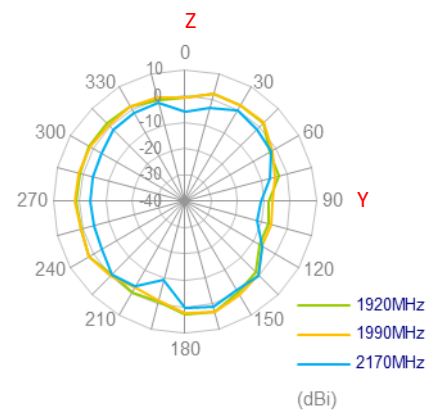
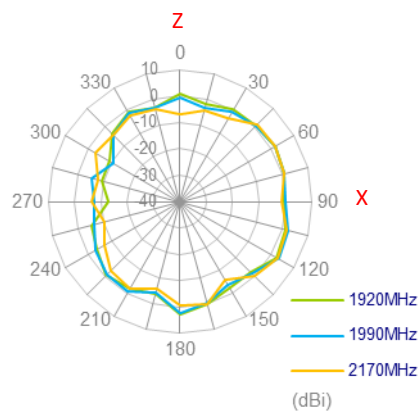
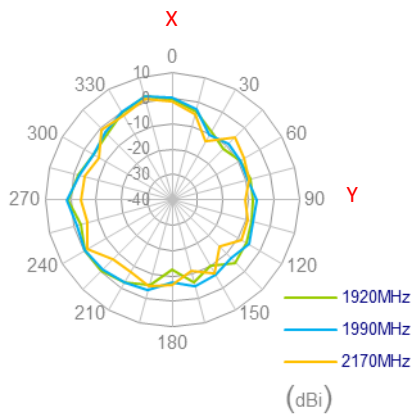

2500MHz

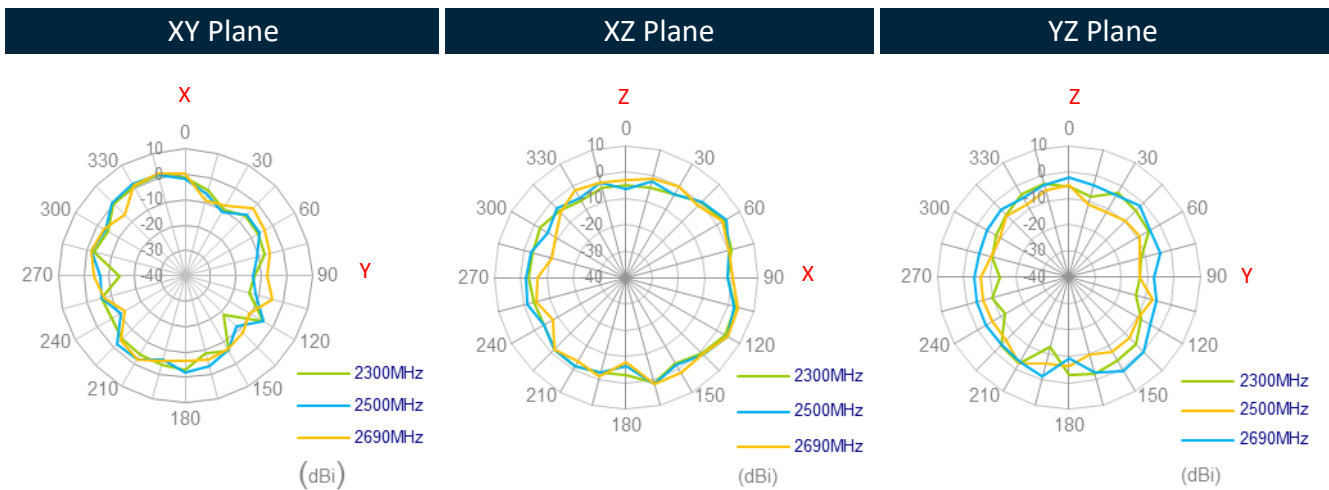
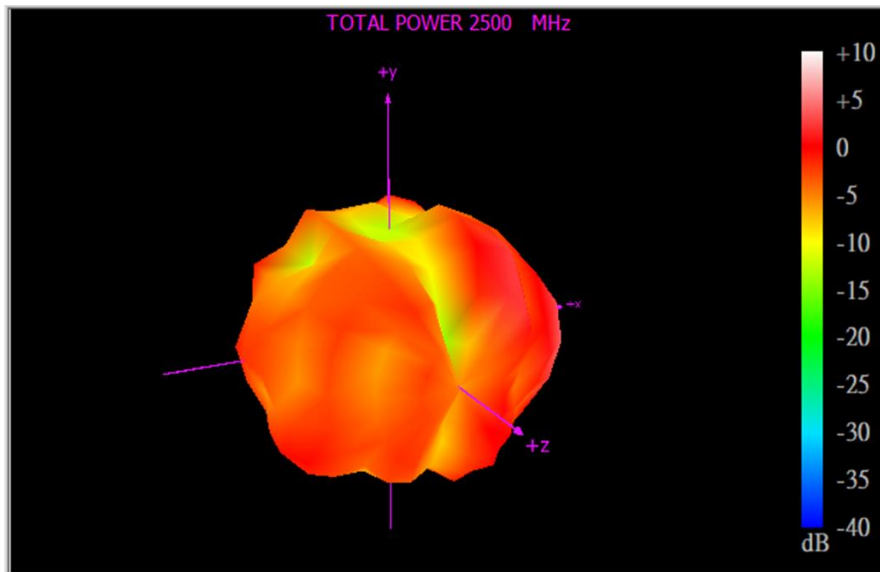

3550MHz

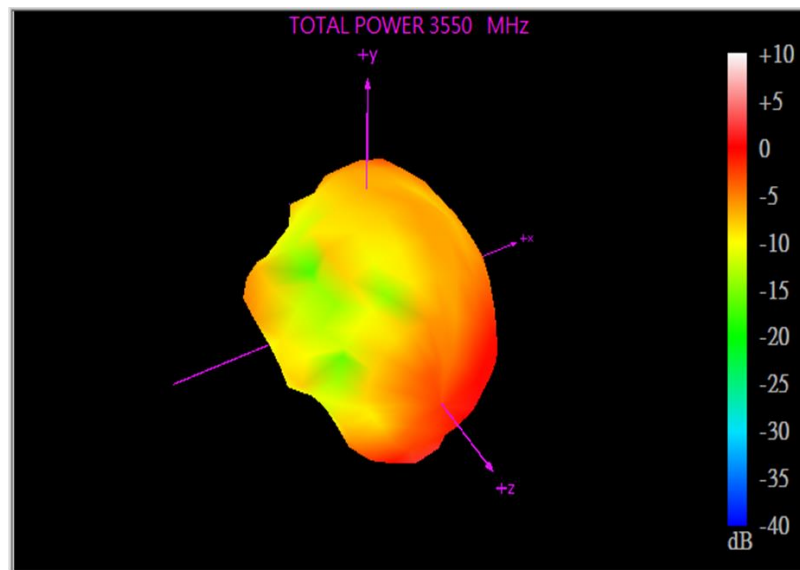

XY Plane

XZ Plane

YZ Plane

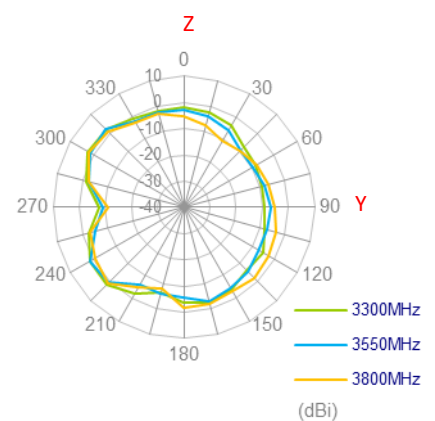
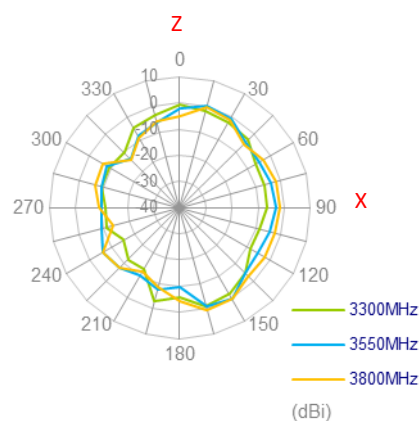
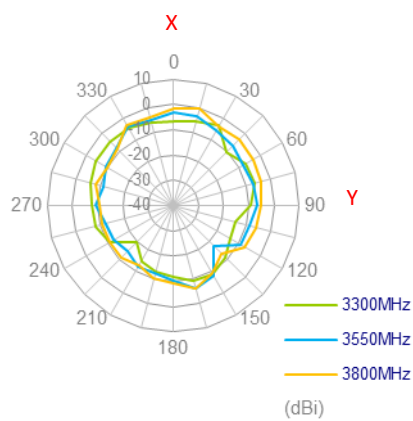

5550MHz

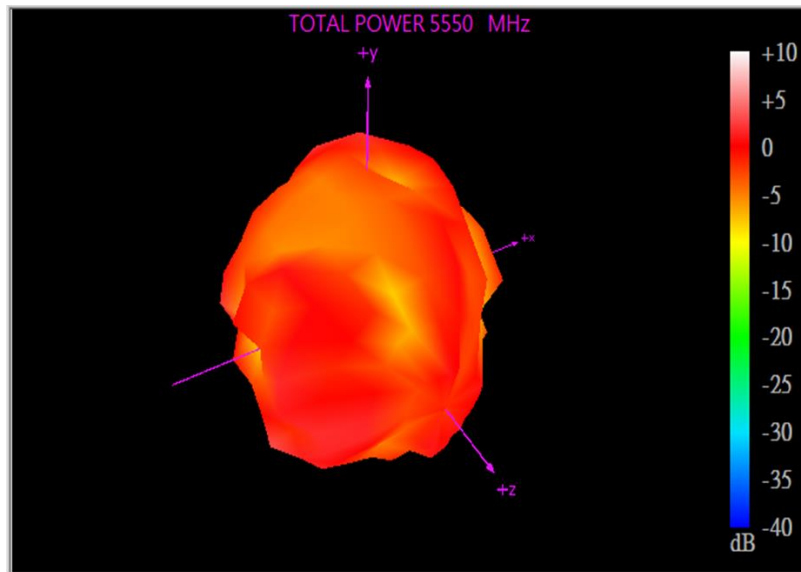

XY Plane

XZ Plane

YZ Plane

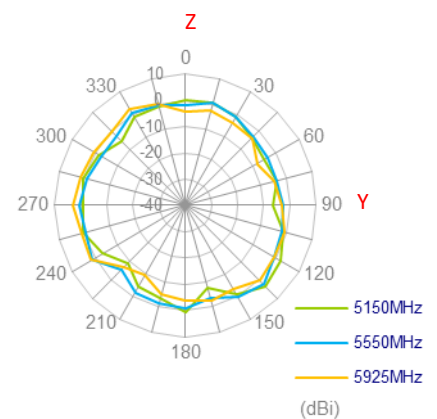
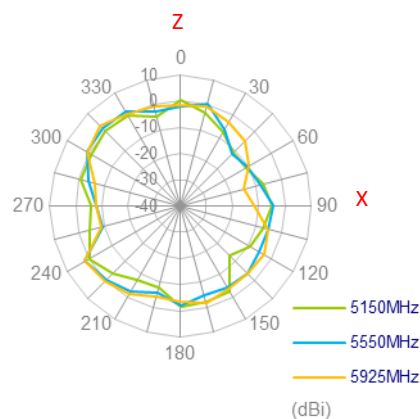
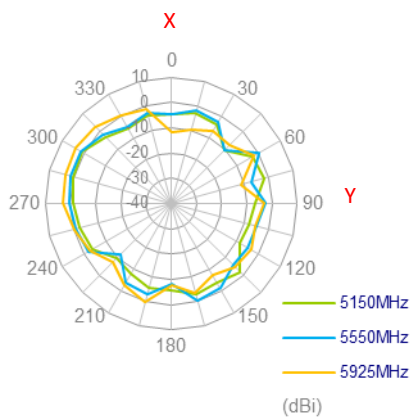

5.3 LTE MIMO2 Radiation Pattern

652MHz

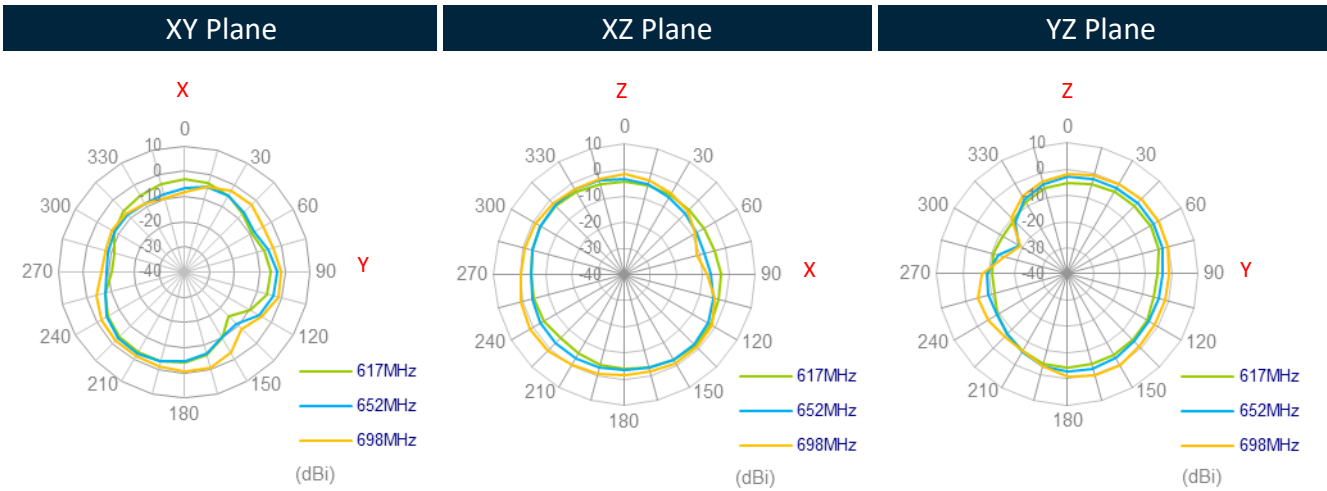
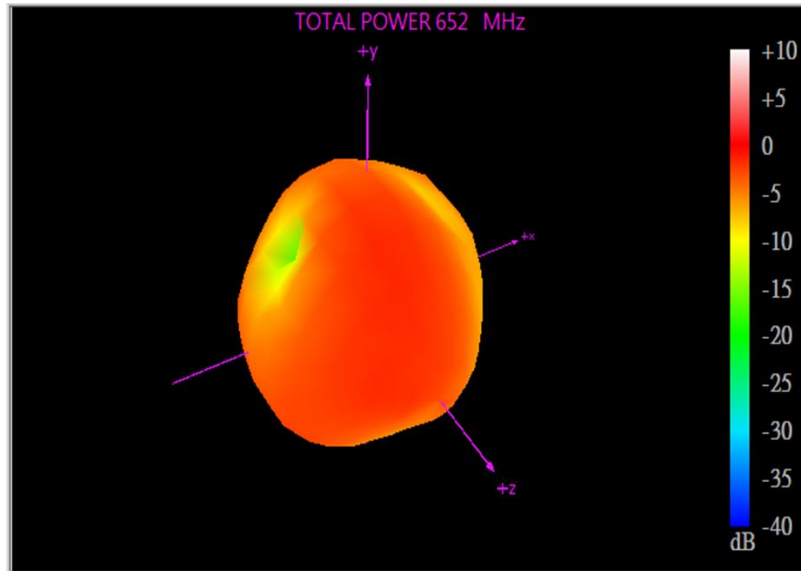

751MHz

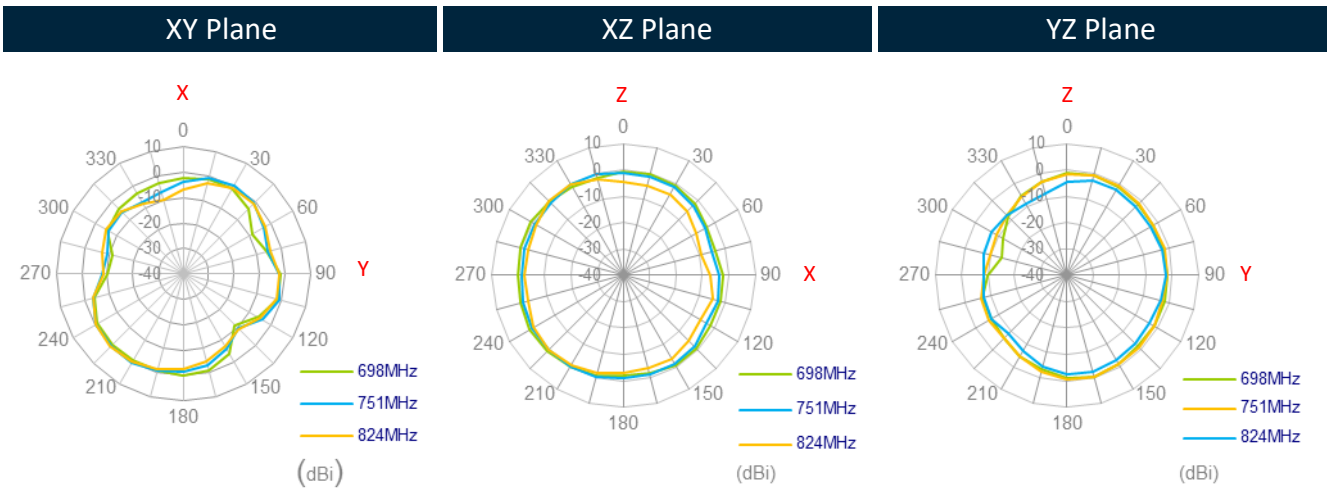
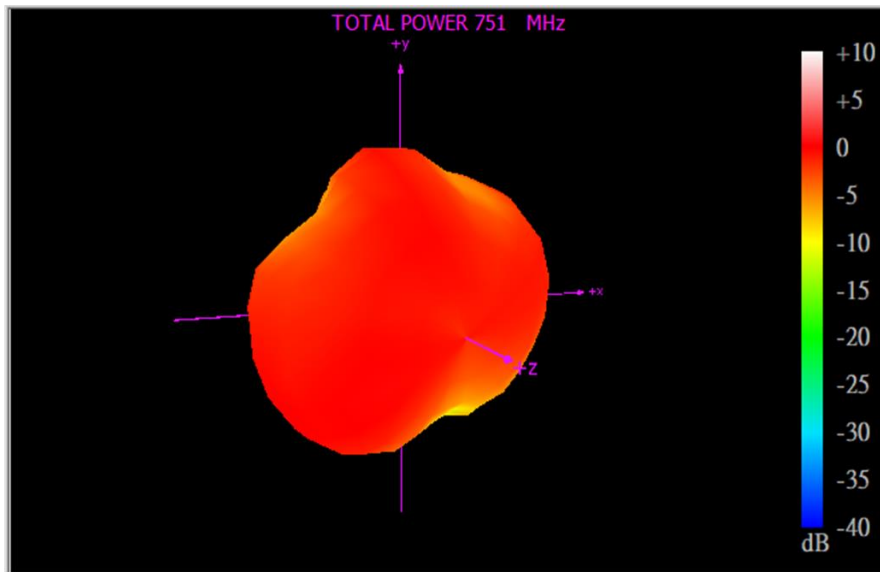

880MHz

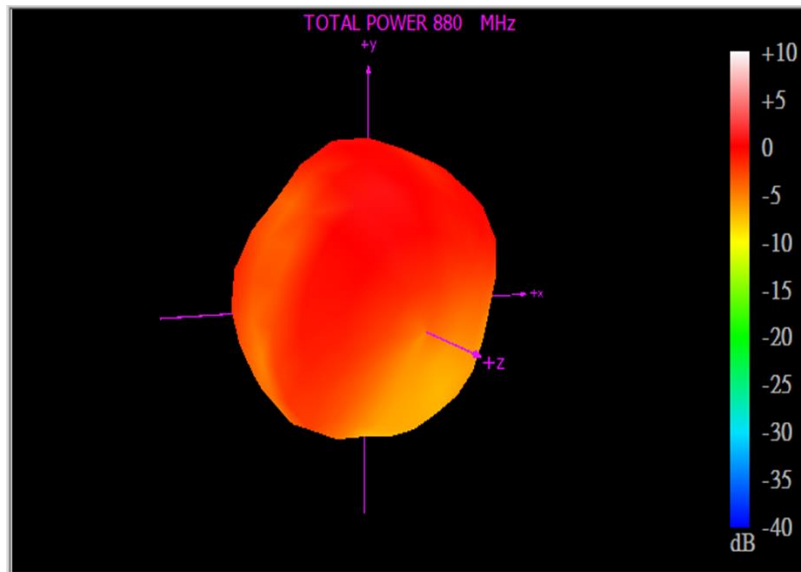

XY Plane

XZ Plane

YZ Plane

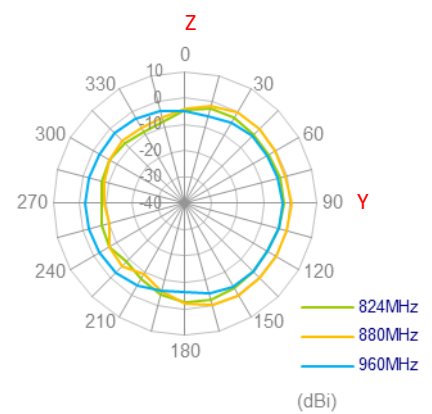
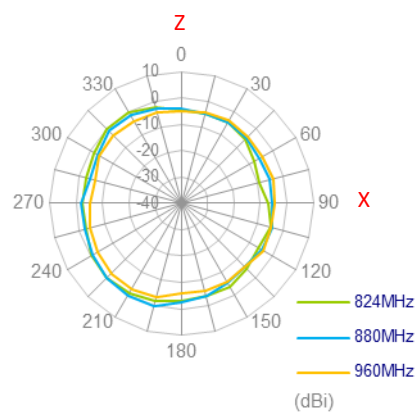
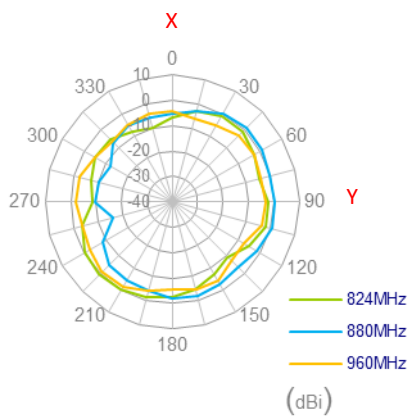

1467MHz

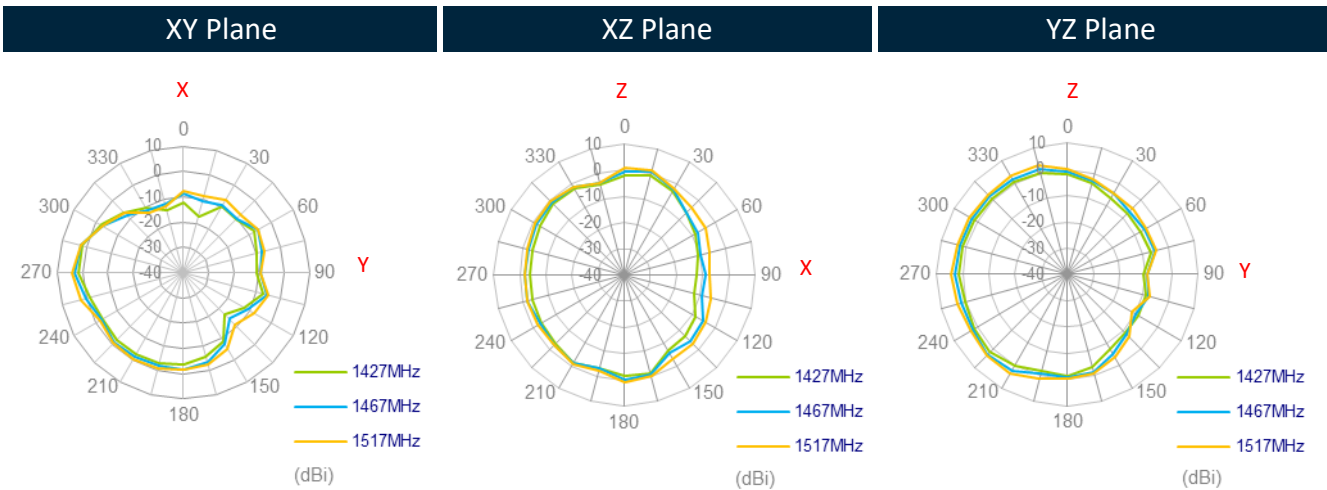
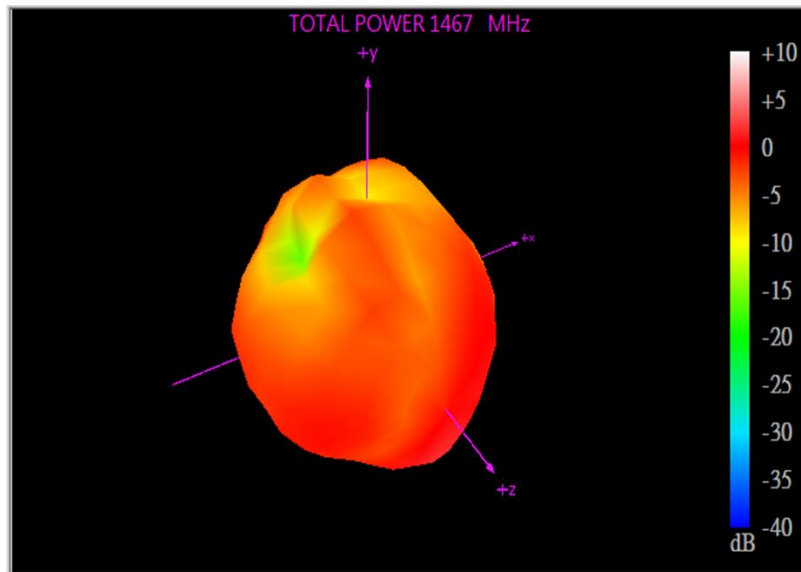

1805MHz

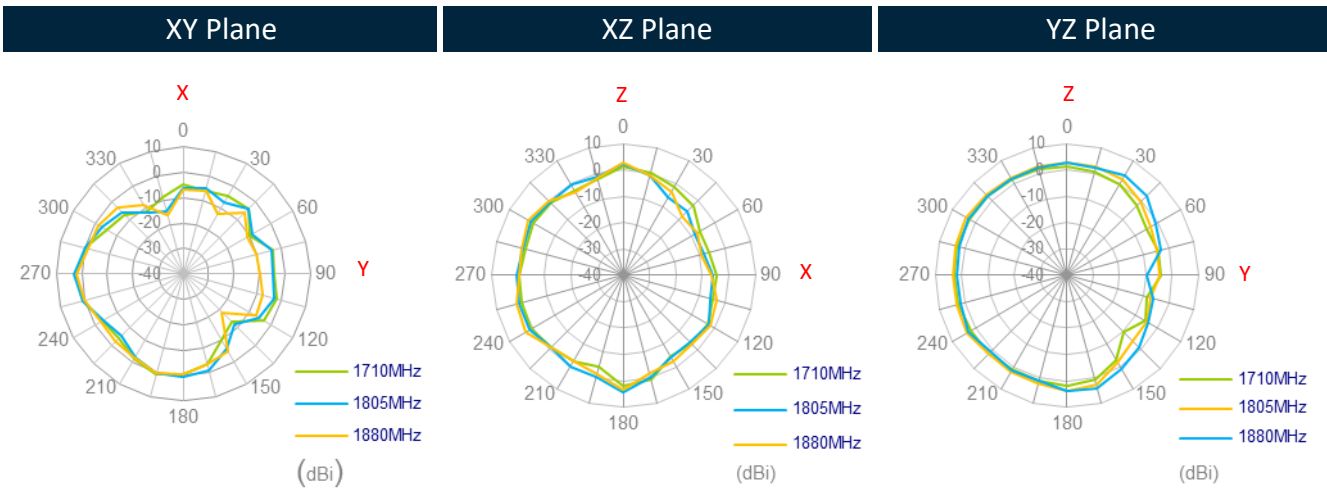
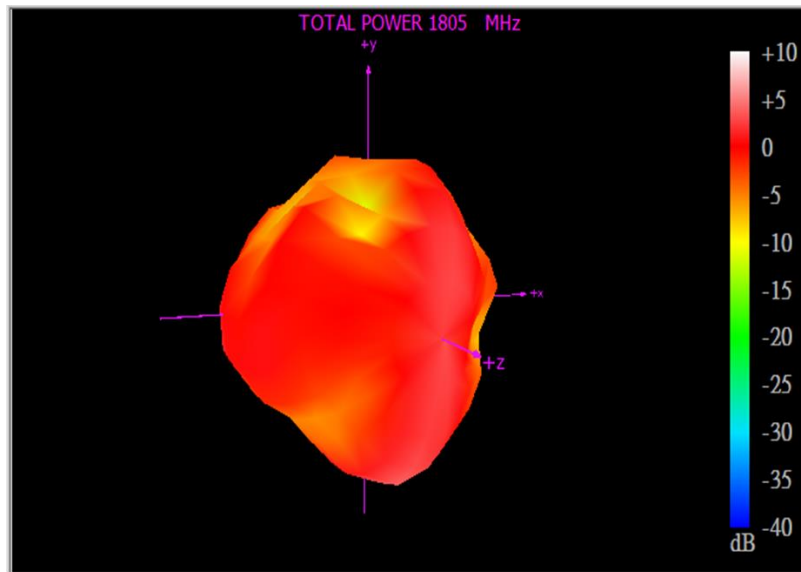

1920MHz

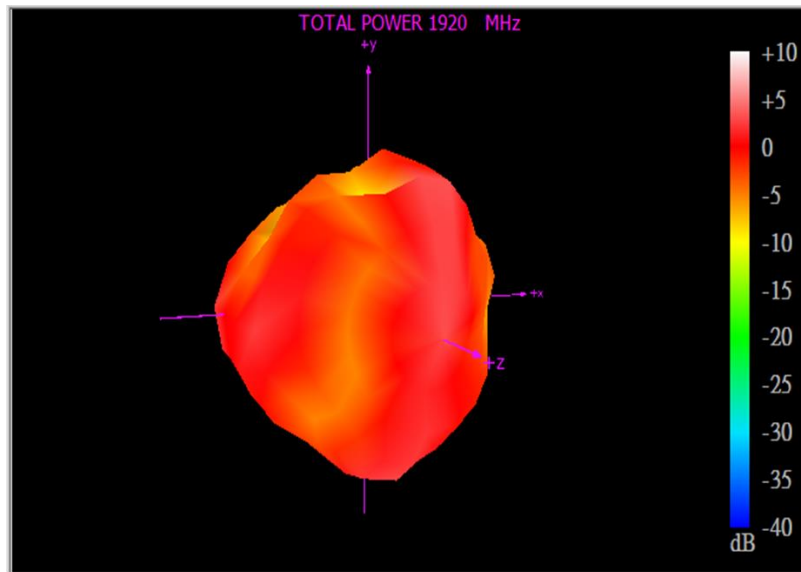

XY Plane

XZ Plane

YZ Plane

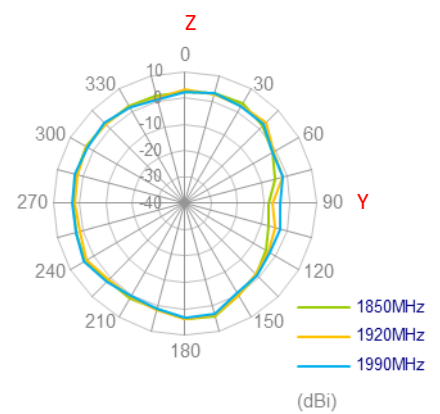
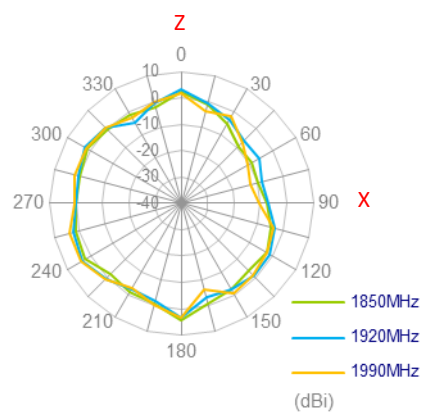
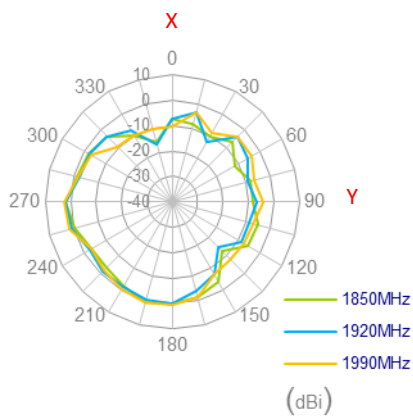

1990MHz

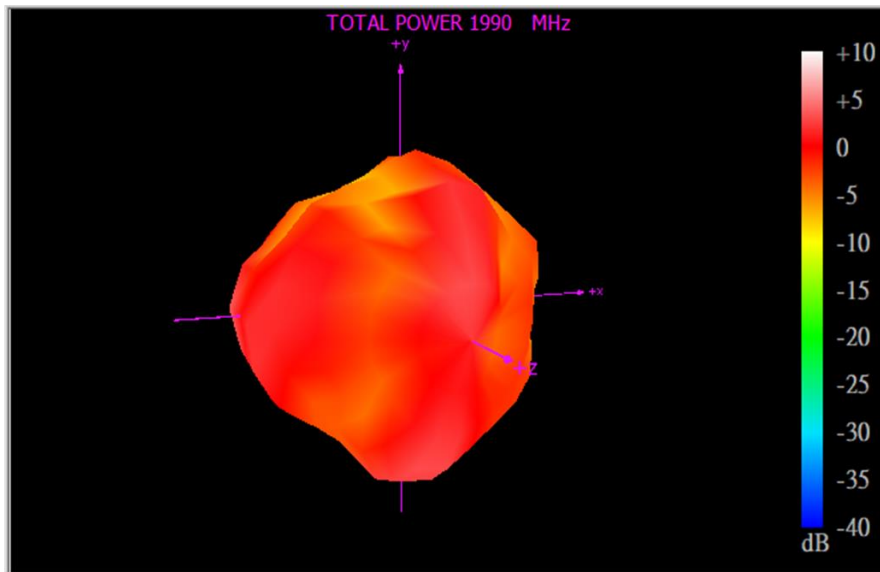

XY Plane

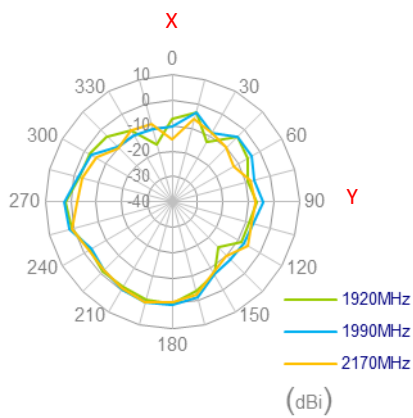

XZ Plane

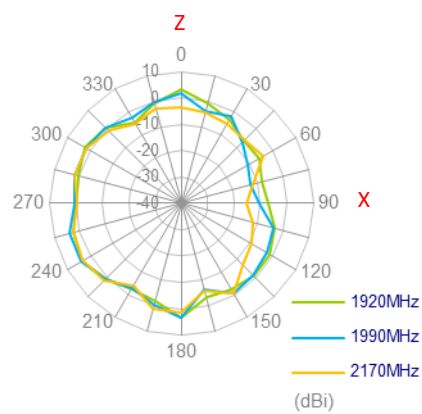

YZ Plane

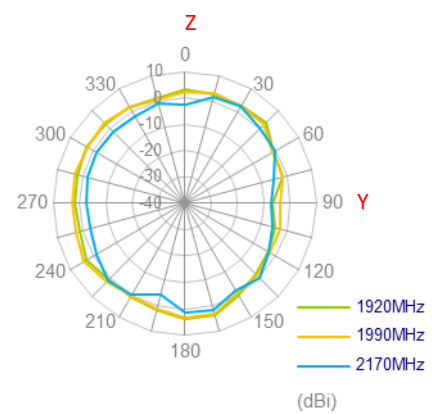

2500MHz

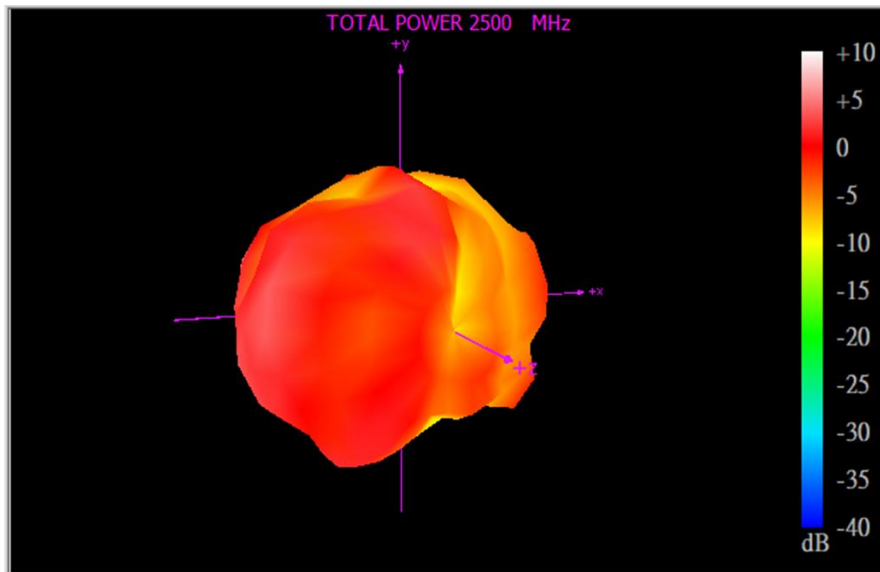

XY Plane

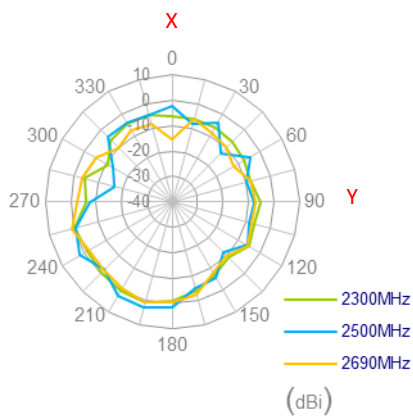

XZ Plane

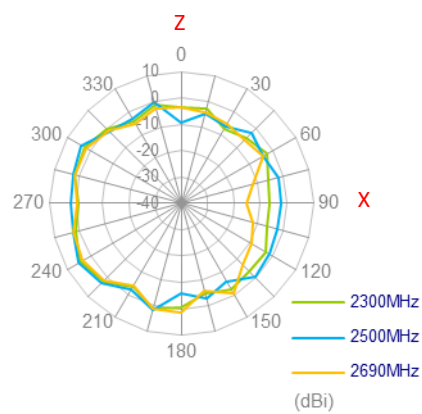

YZ Plane

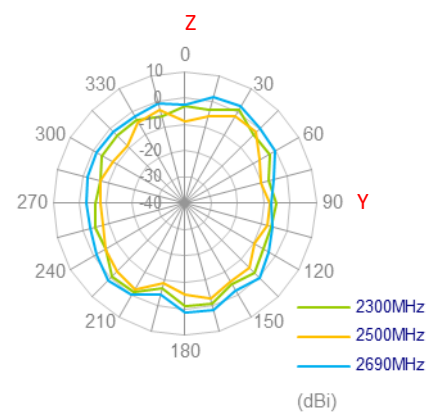

3550MHz

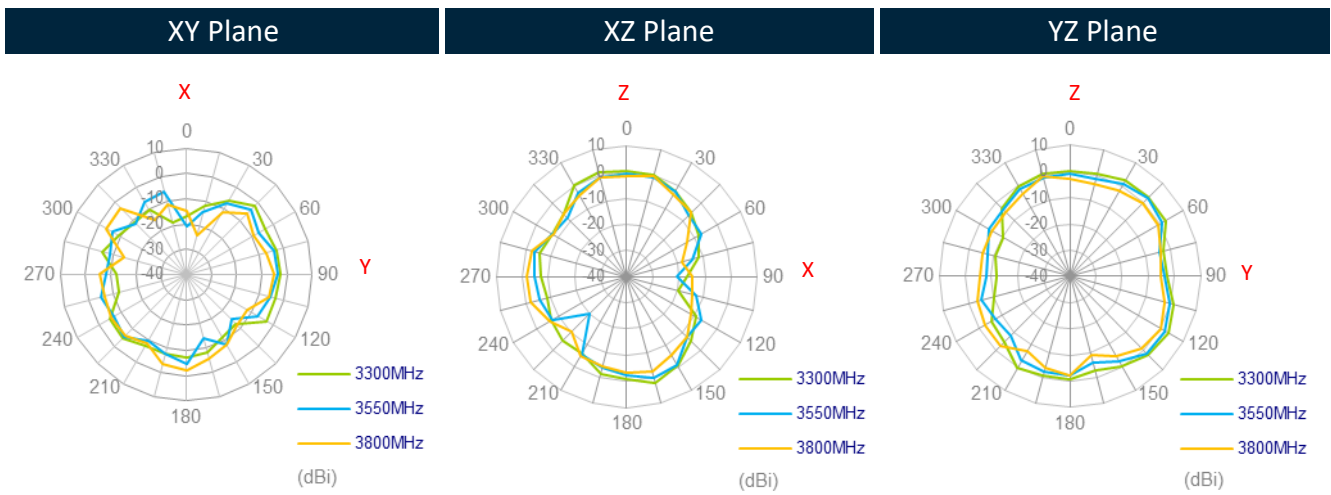
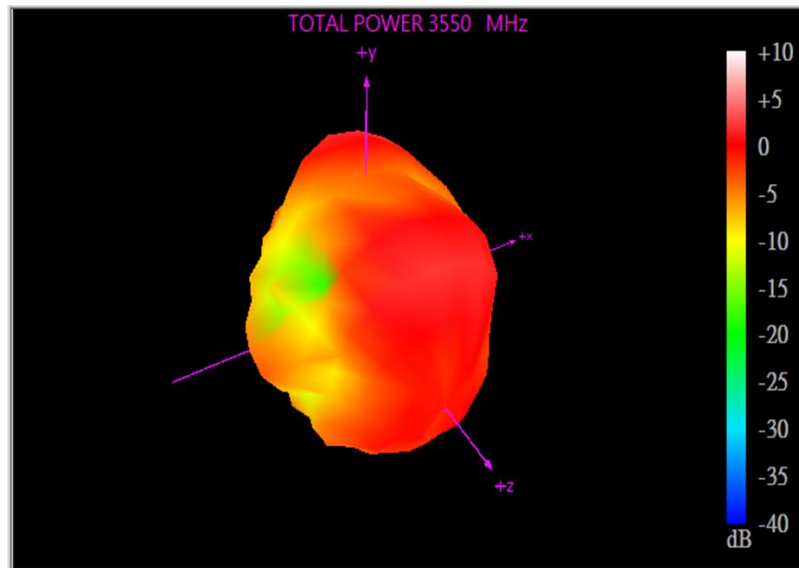

5550MHz

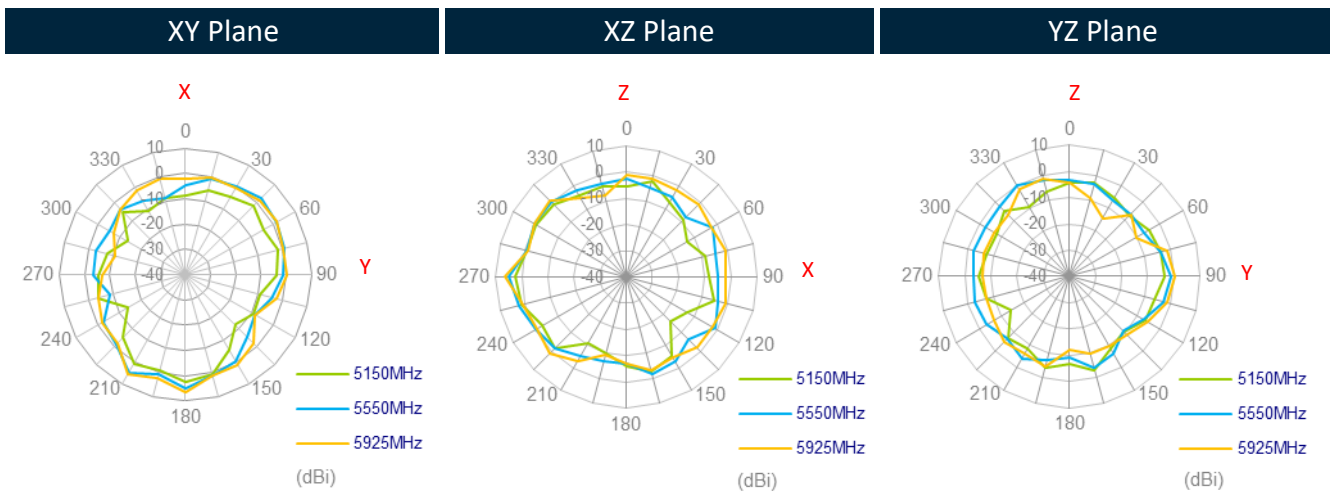
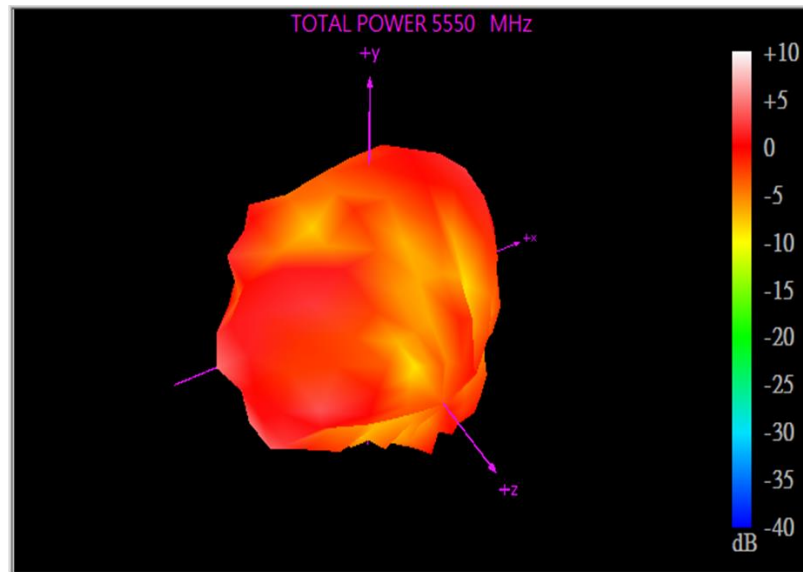

5.4 LTE MIMO3 Radiation Pattern

652MHz

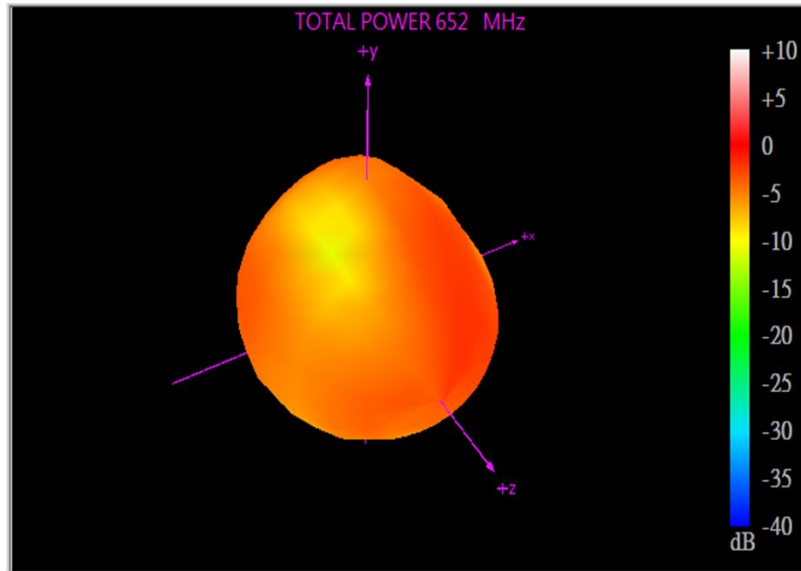

XY Plane

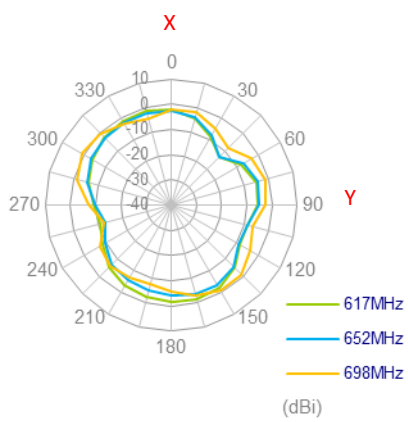

XZ Plane

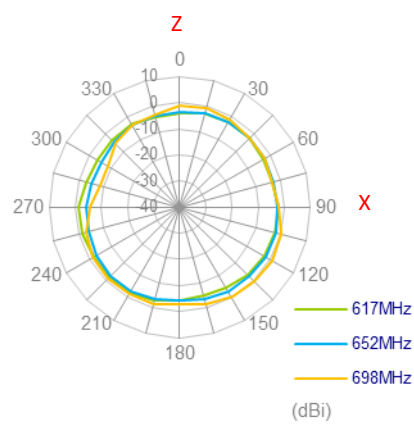

YZ Plane

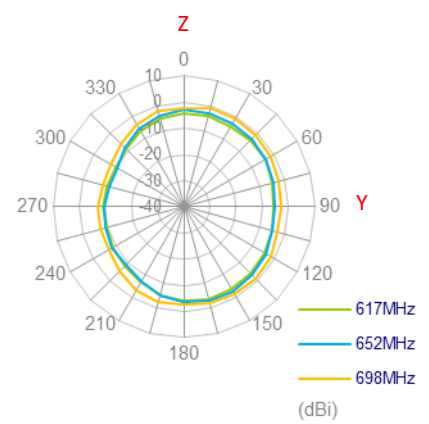

751MHz

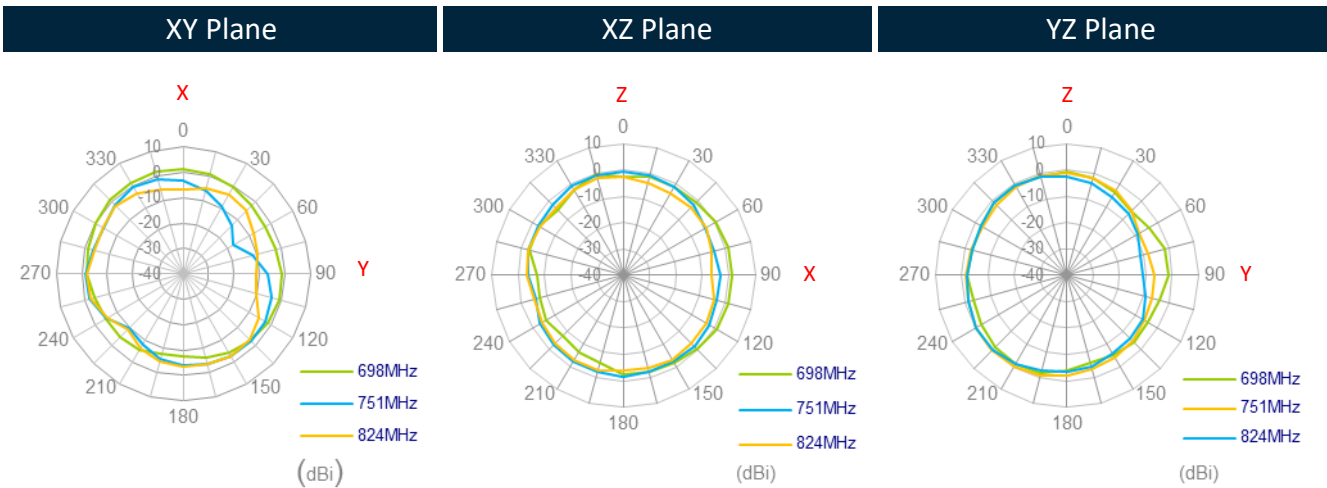
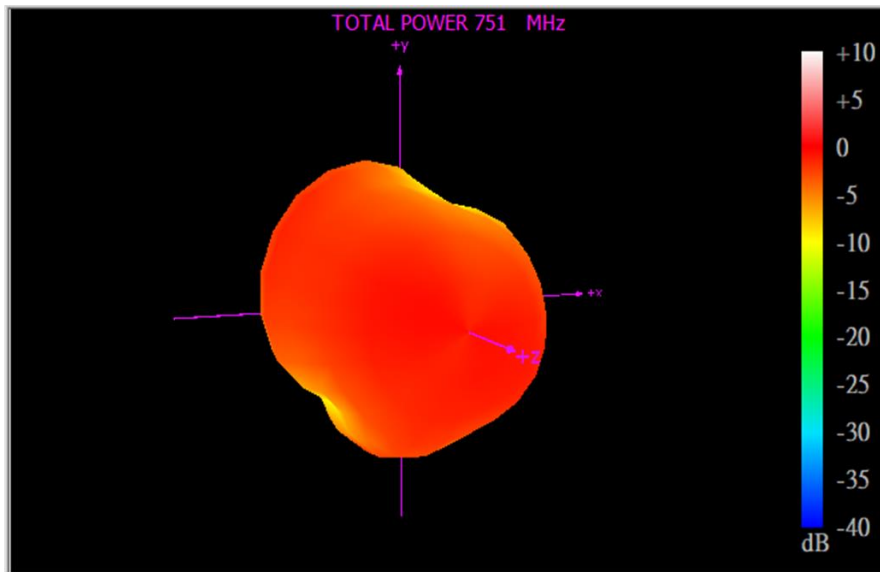

880MHz

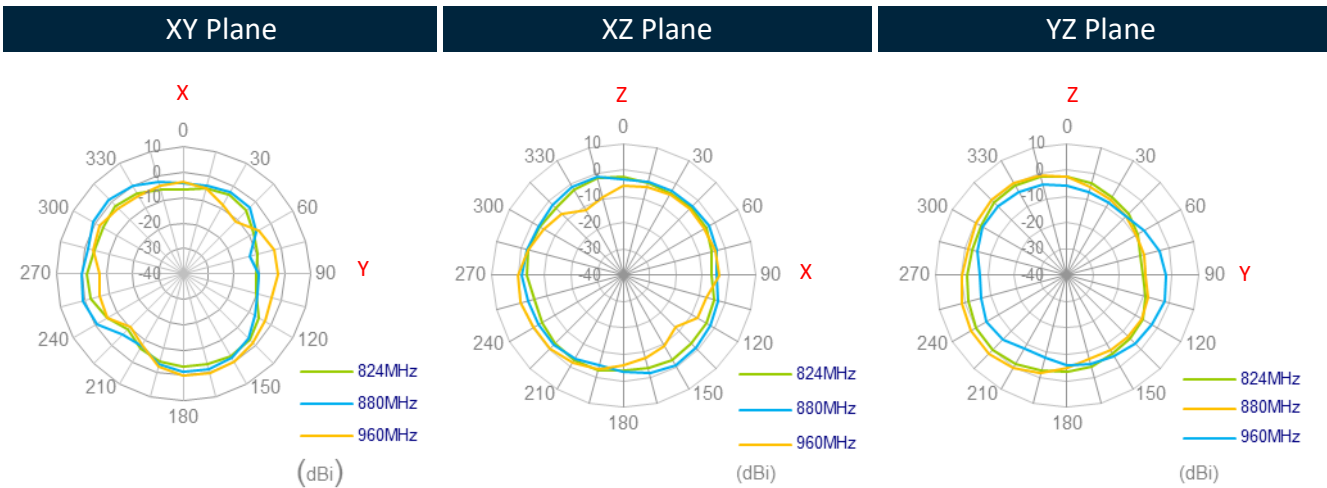
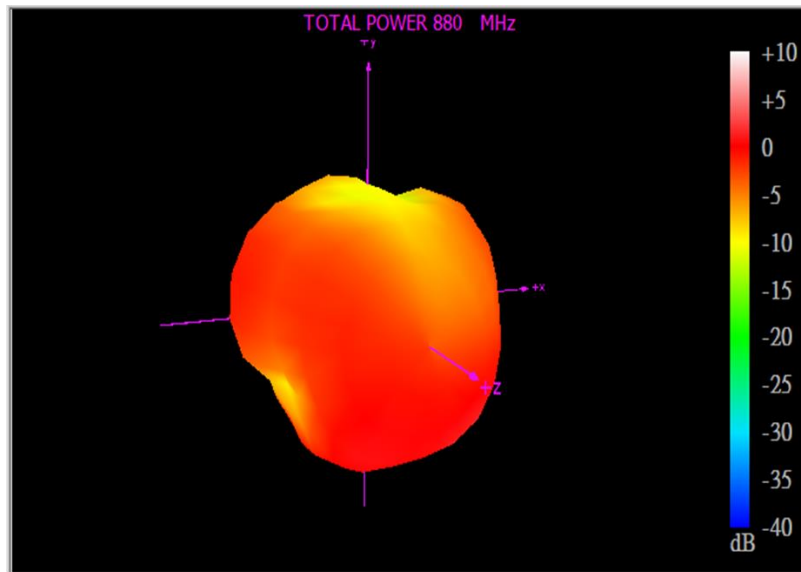

1467MHz

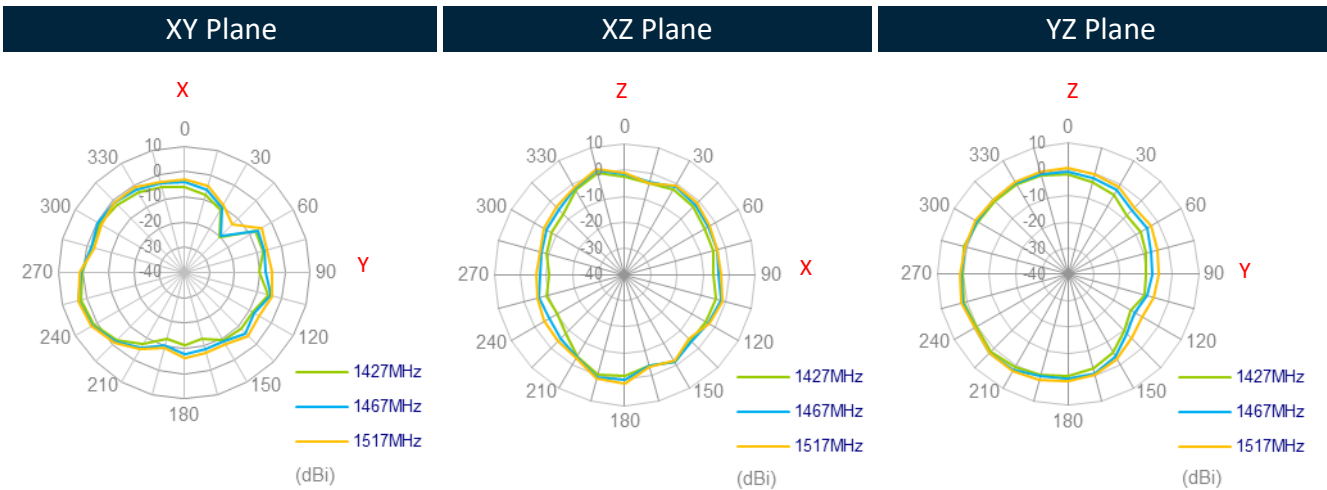
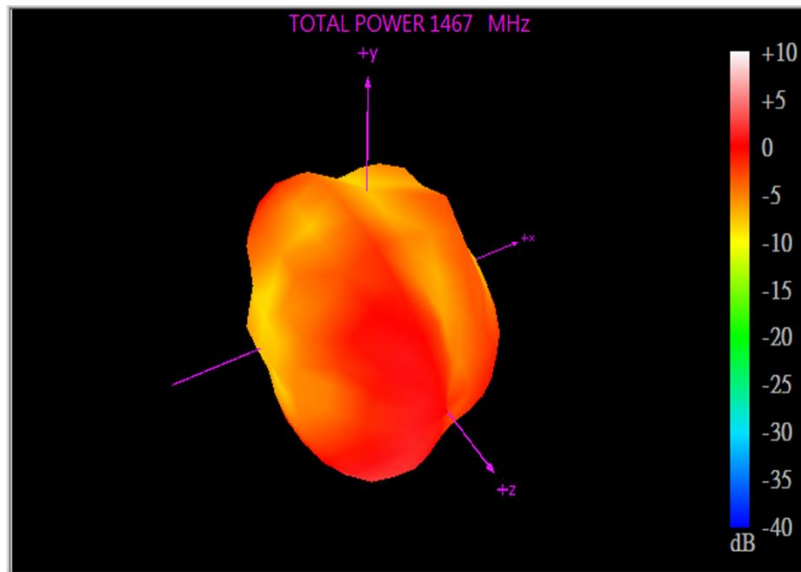

1805MHz

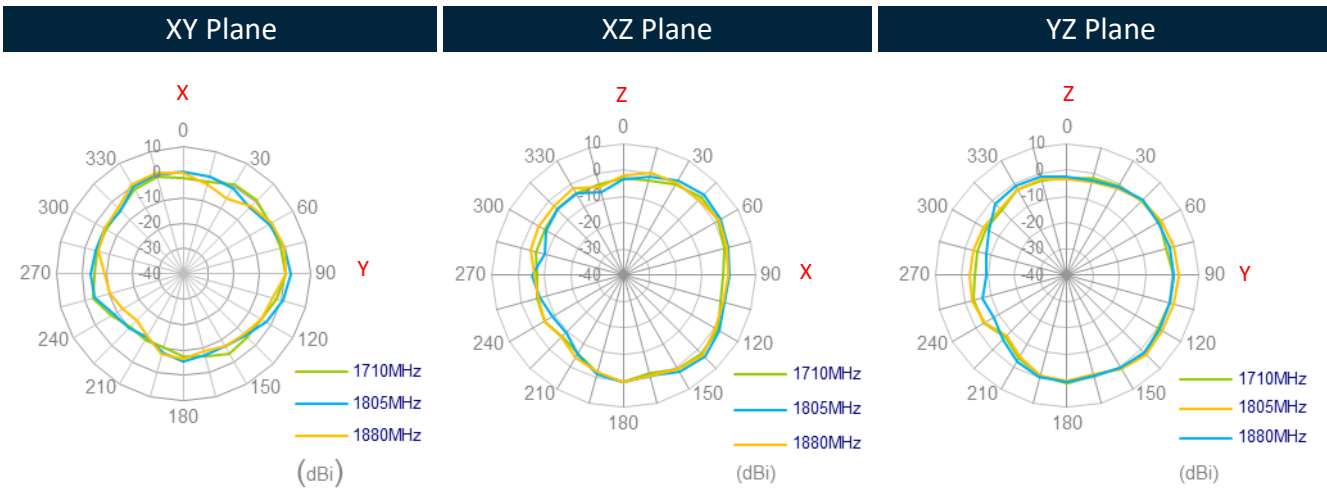
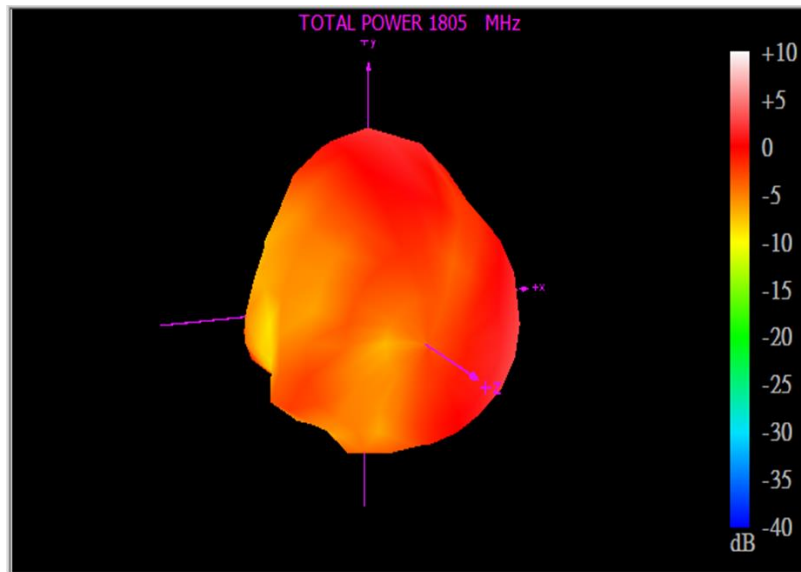

1920MHz

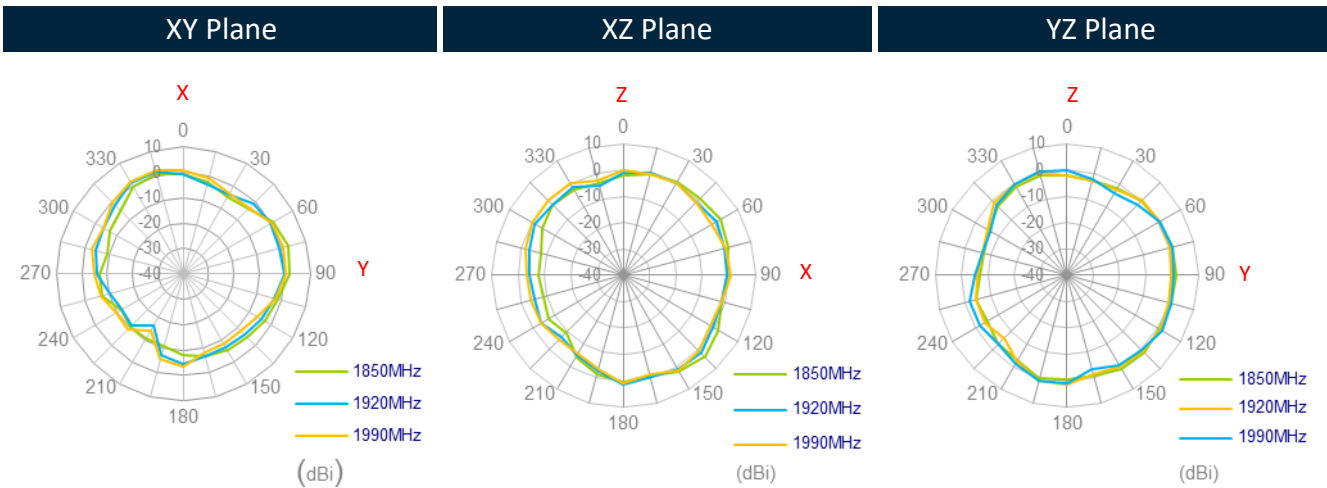
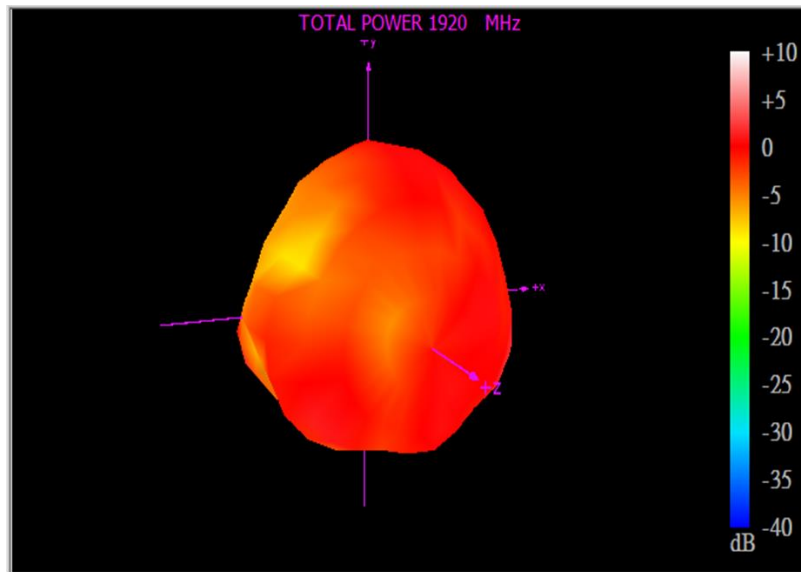

1990MHz

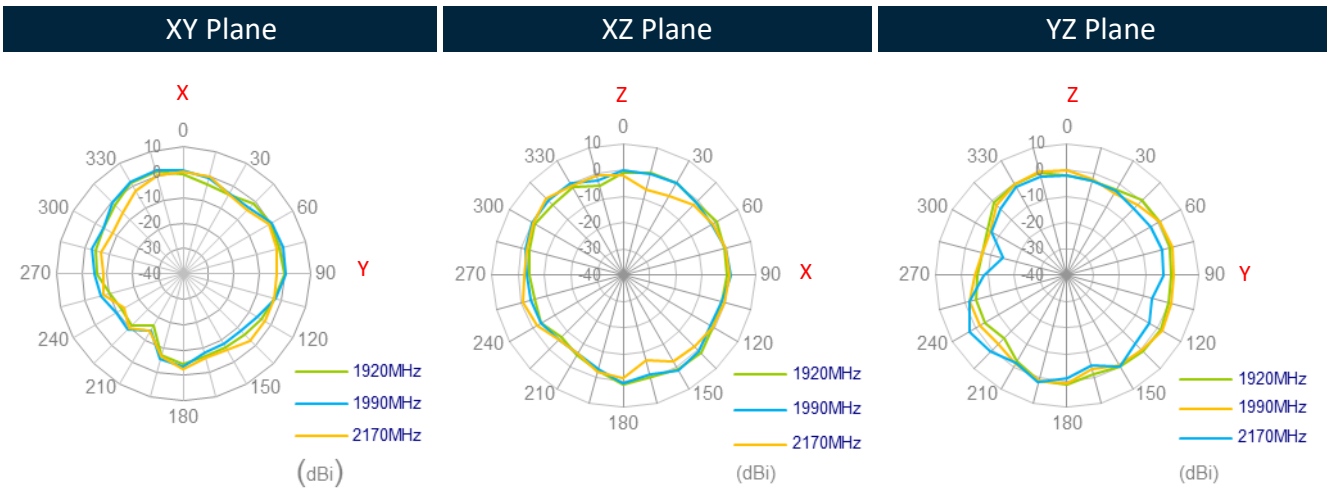
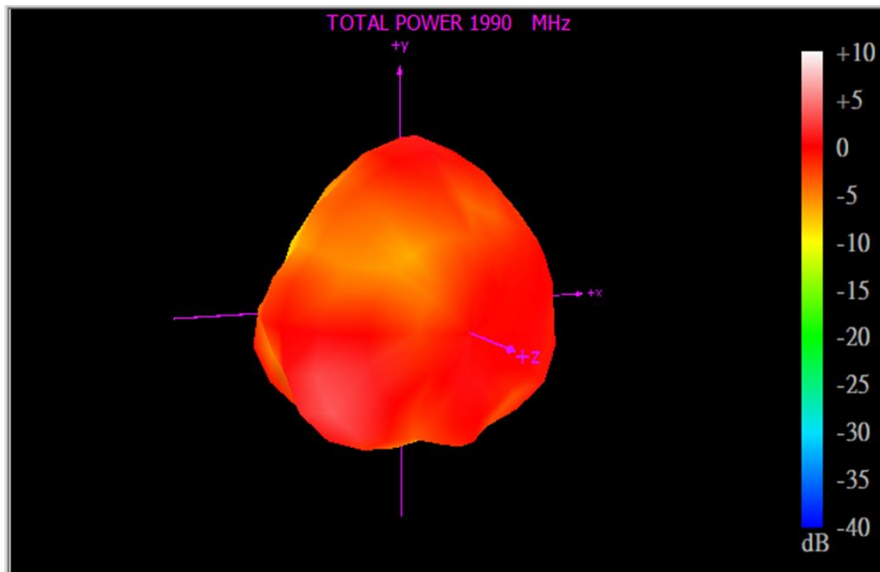

2500MHz

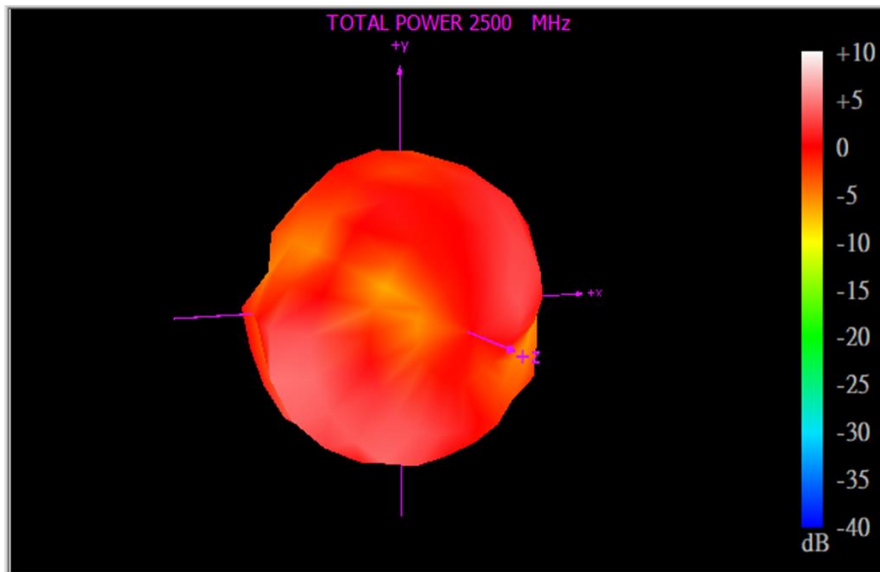

XY Plane

XZ Plane

YZ Plane

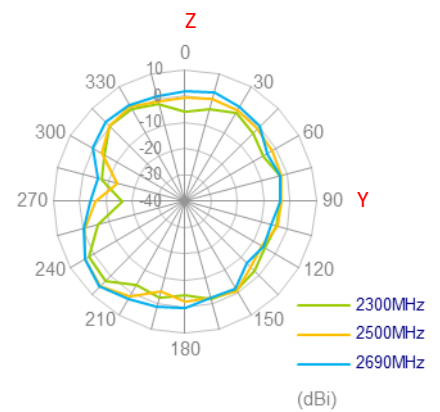
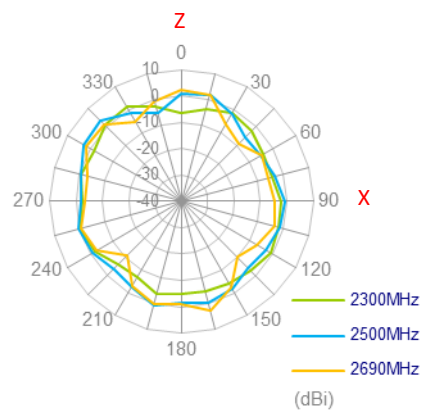
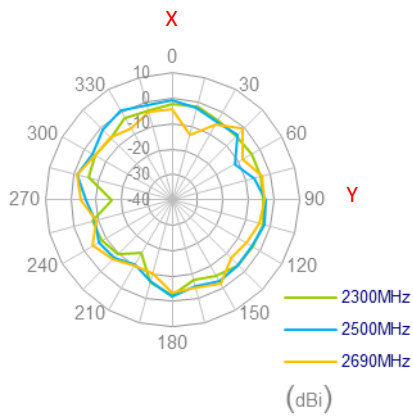

3550MHz

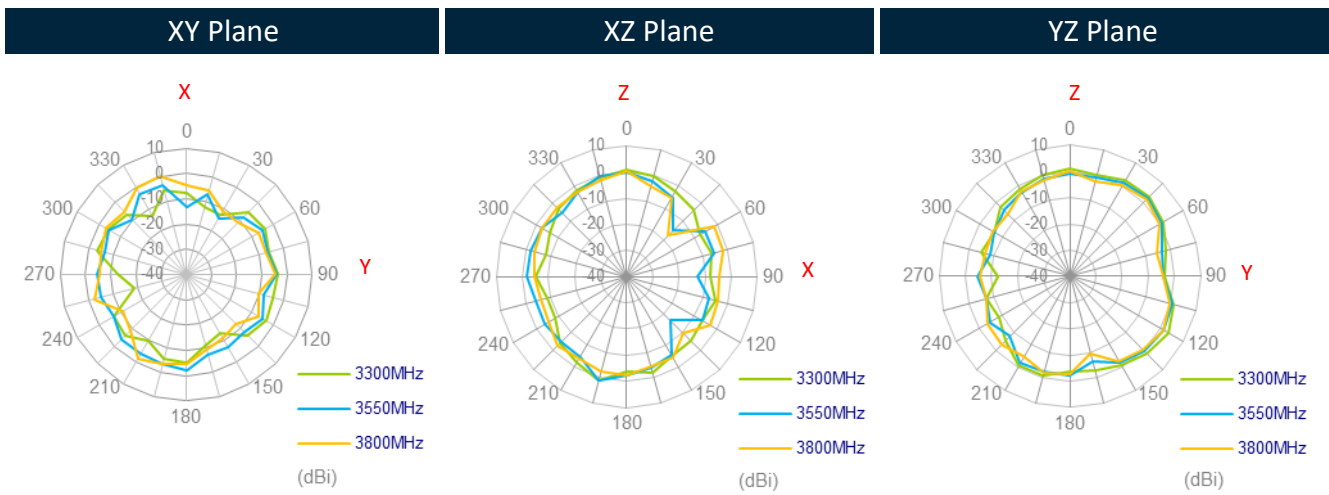
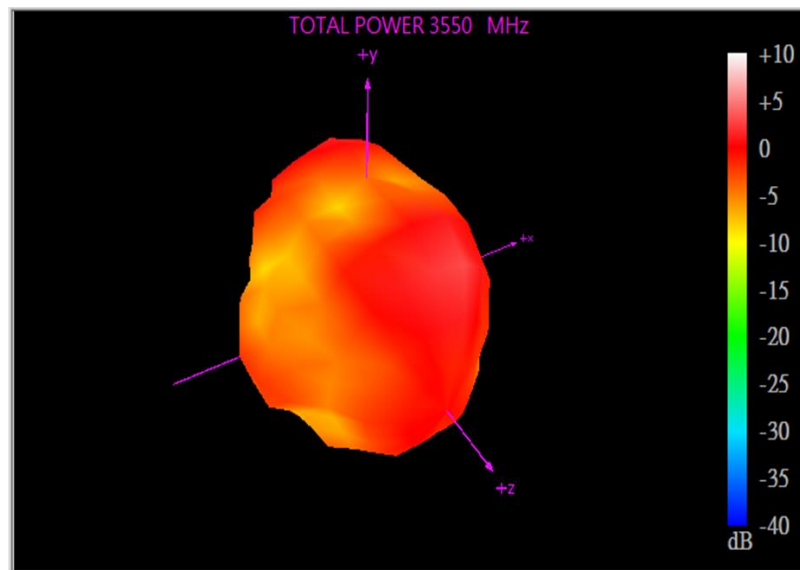

5550MHz

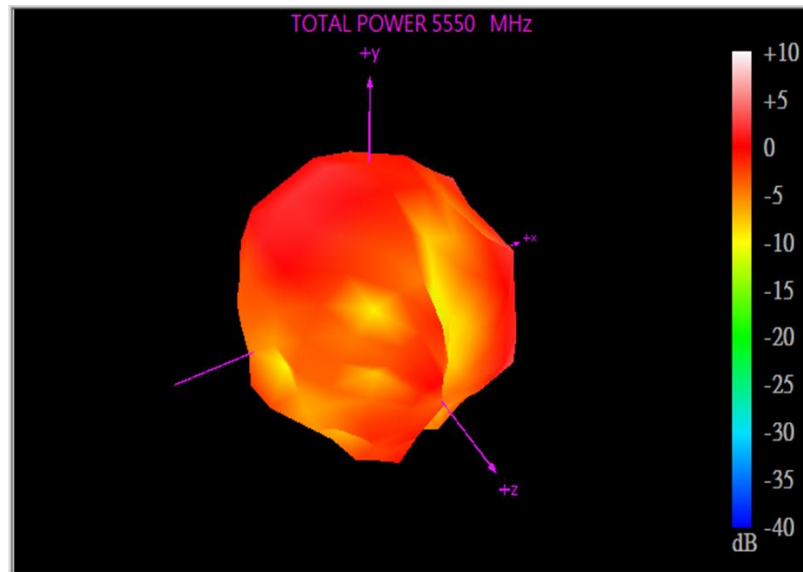

XY Plane

XZ Plane

YZ Plane

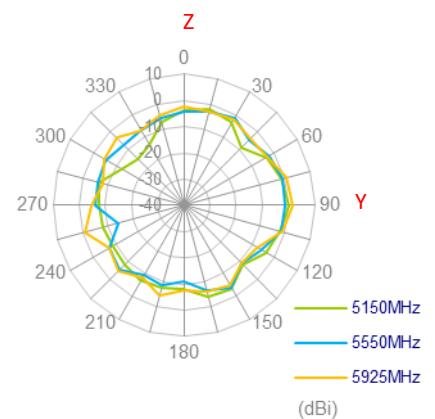
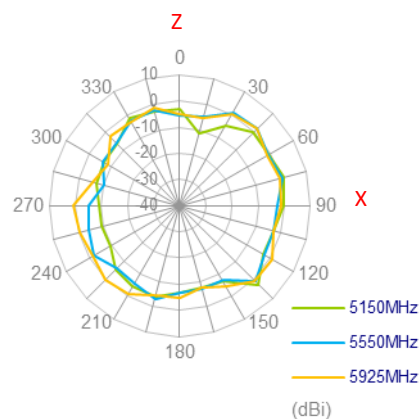
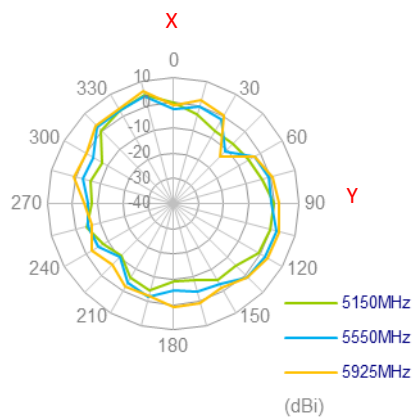

5.5 LTE MIMO4 Radiation Pattern

652MHz

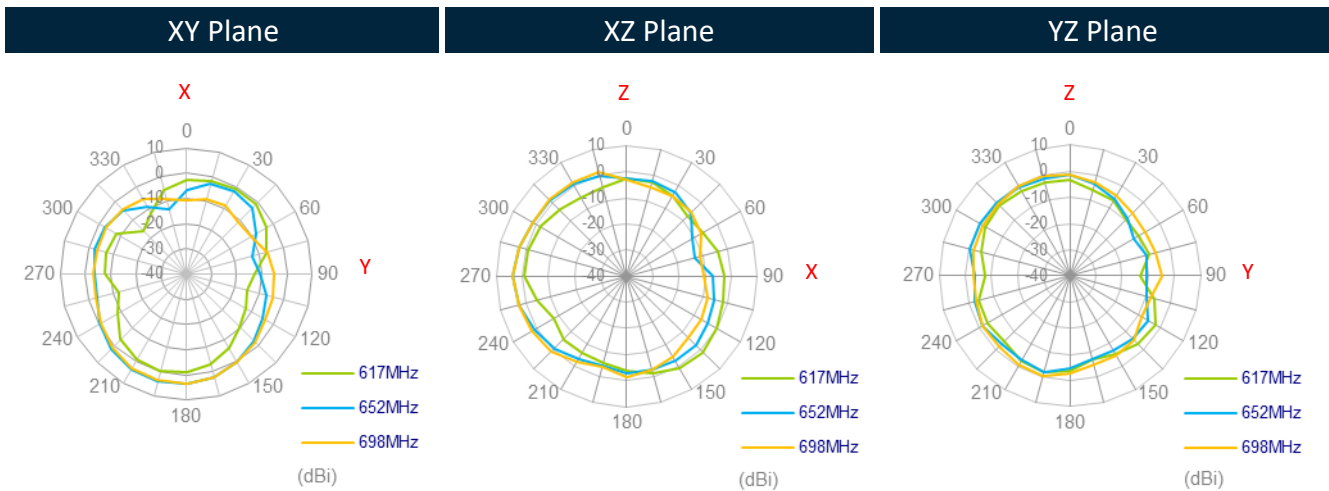
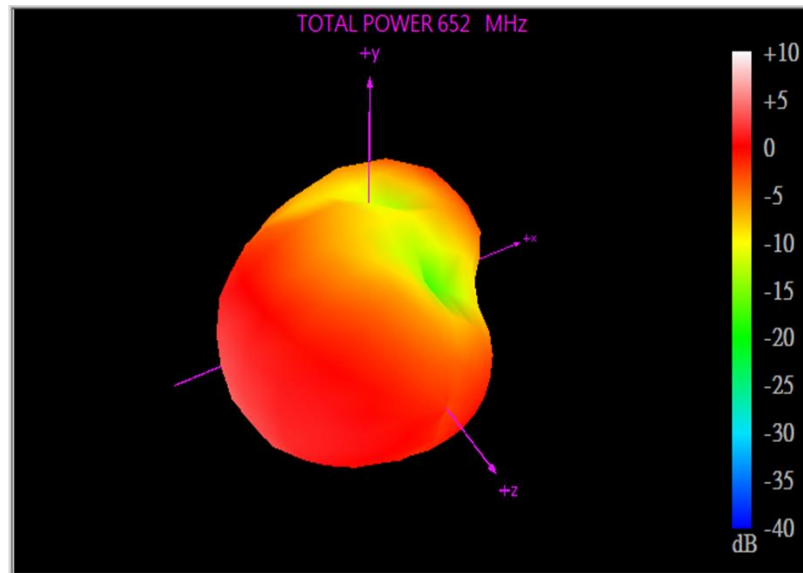

751MHz

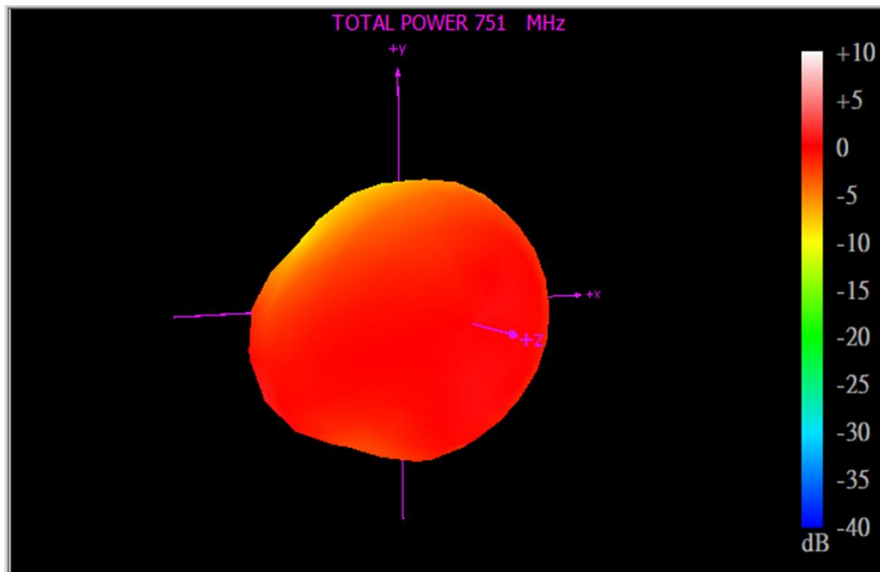

XY Plane

XZ Plane

YZ Plane

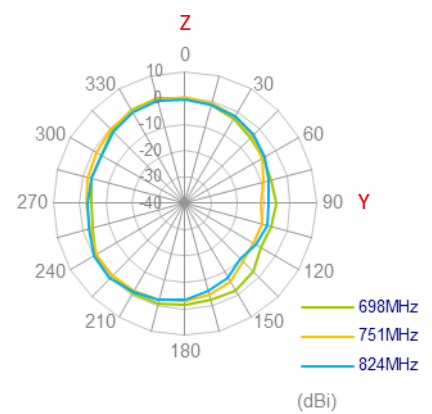
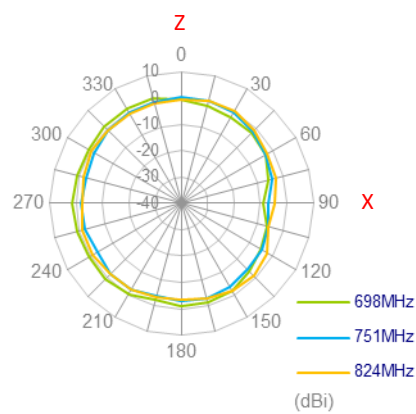
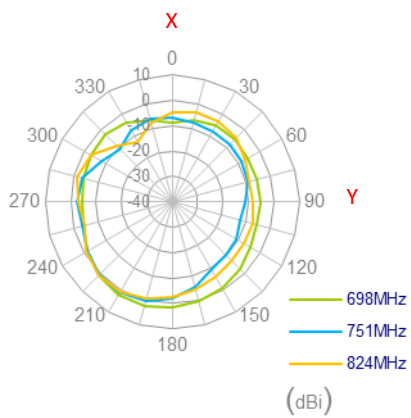

880MHz

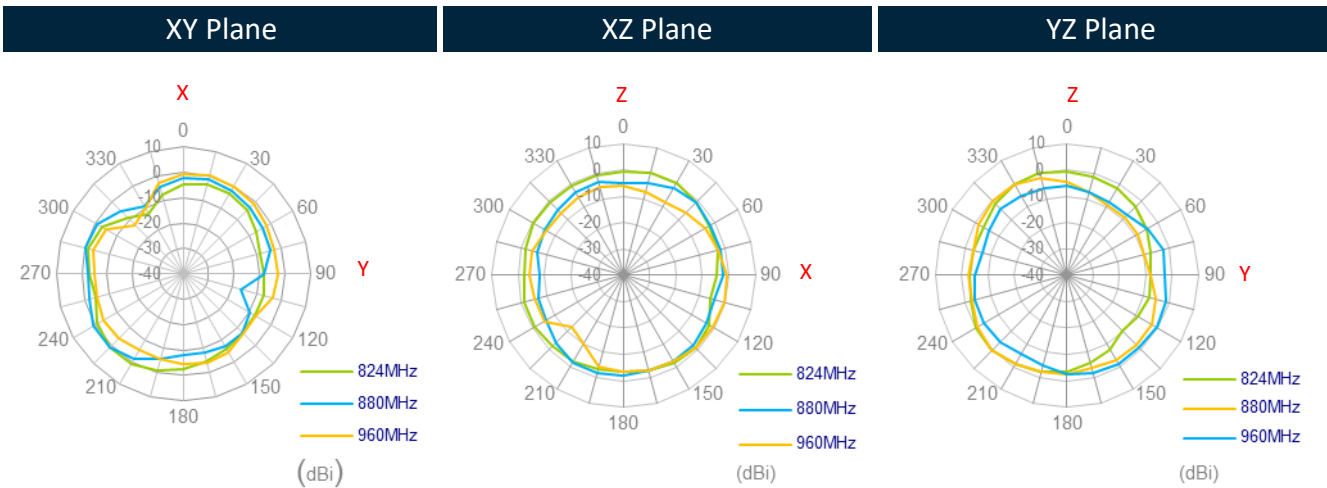
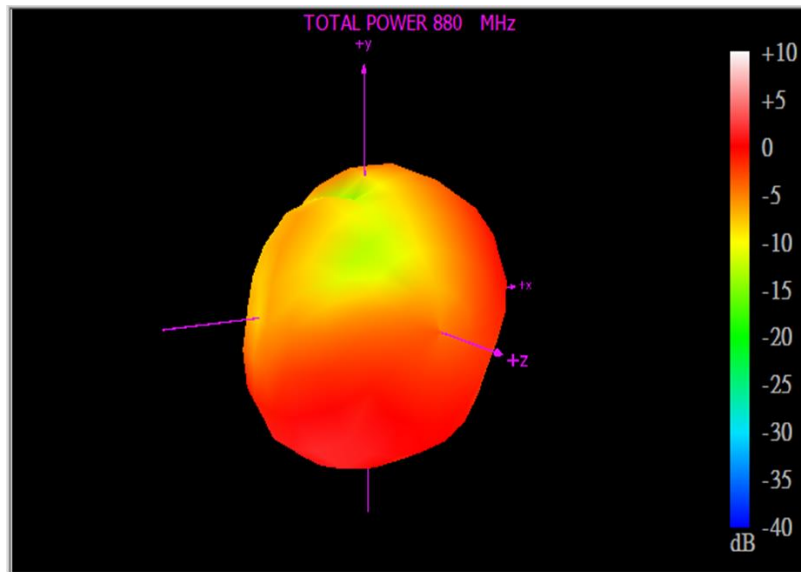

1467MHz

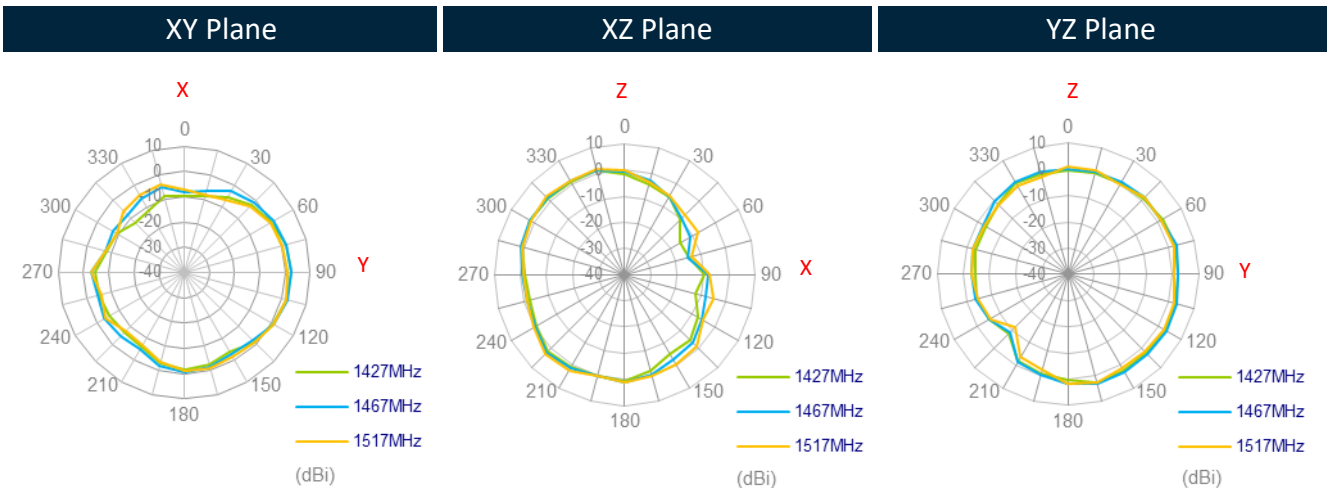
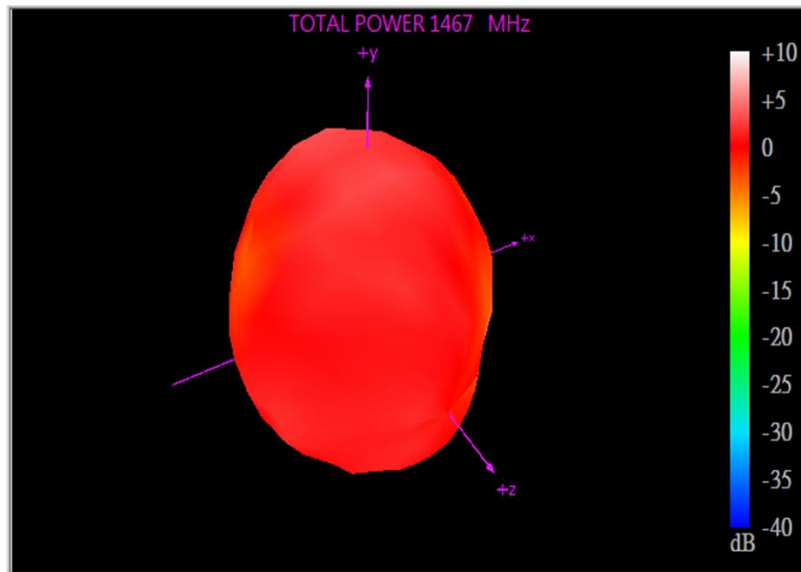

1805MHz

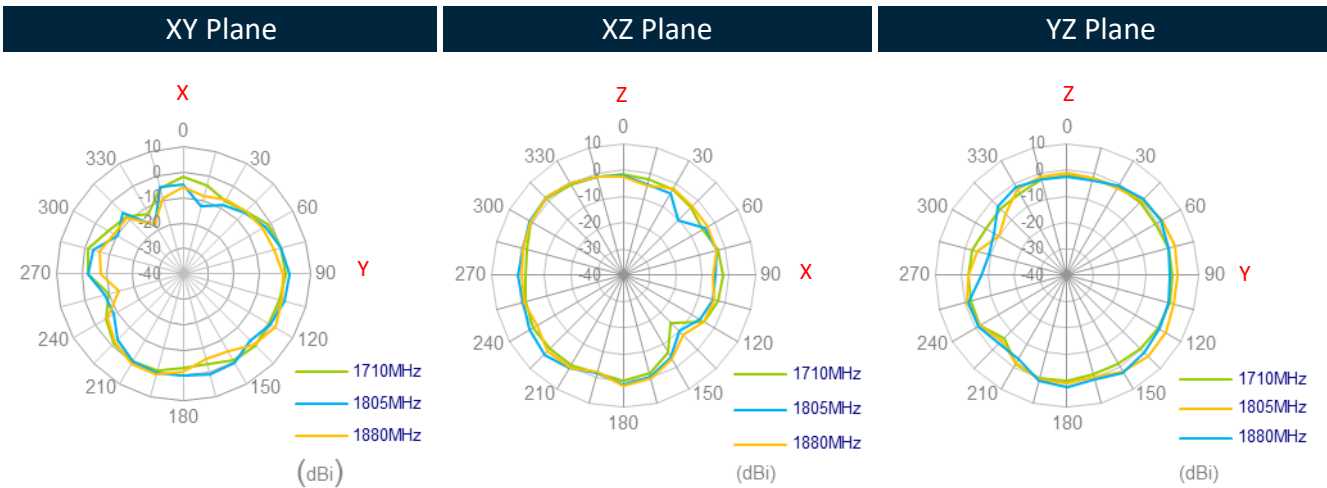
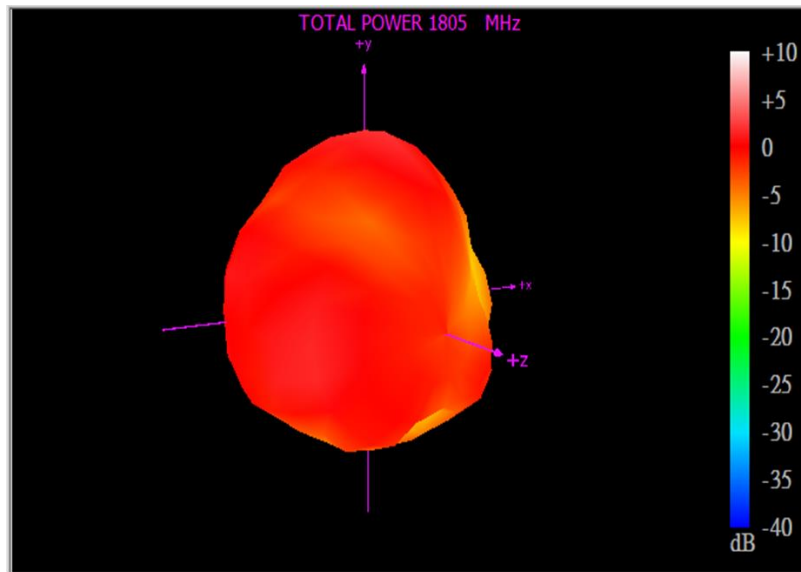

1920MHz

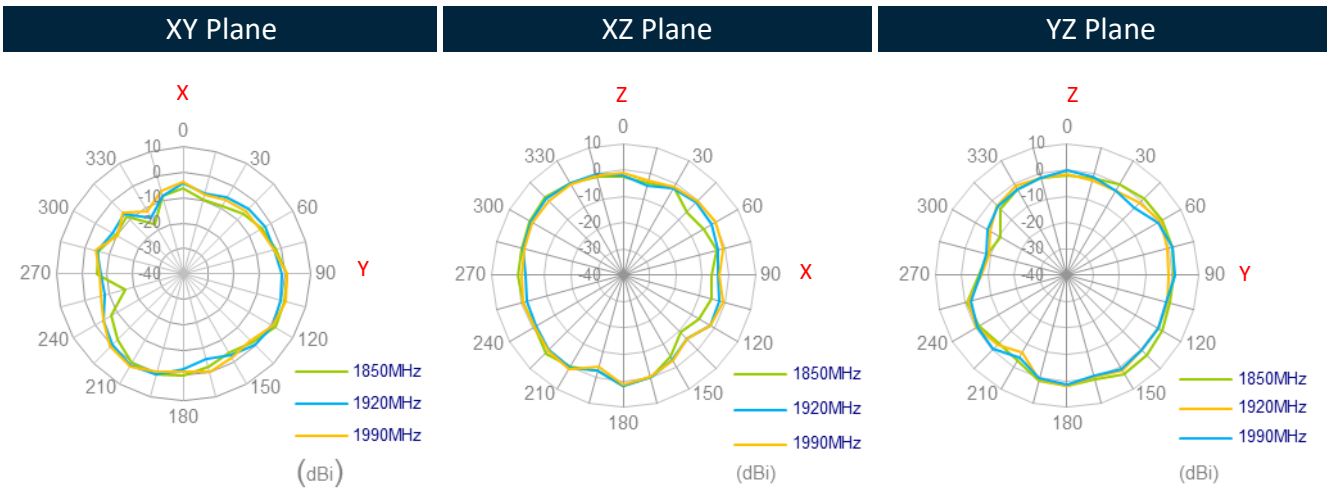
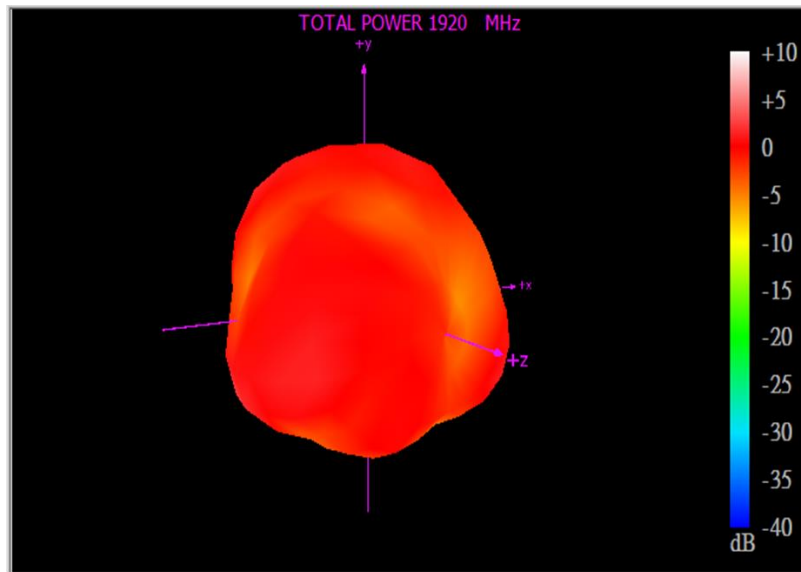

1990MHz

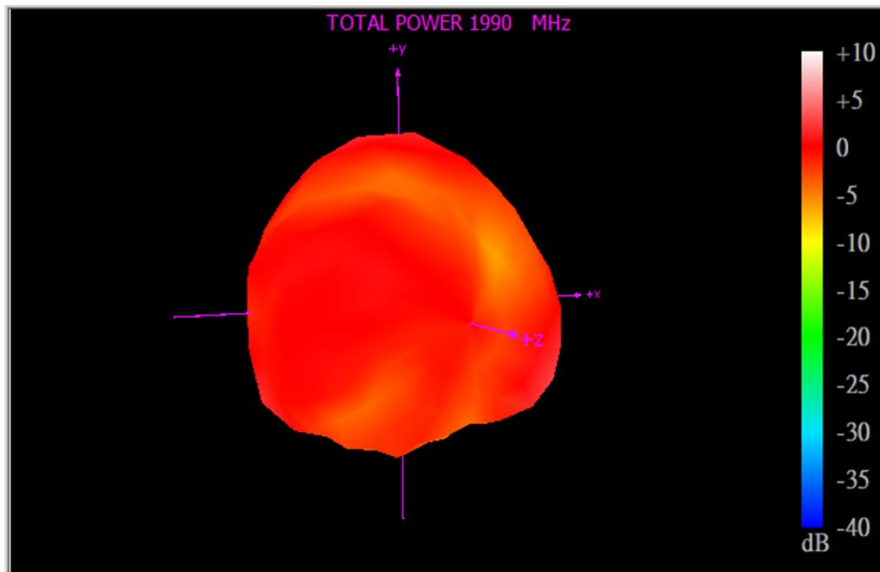

XY Plane

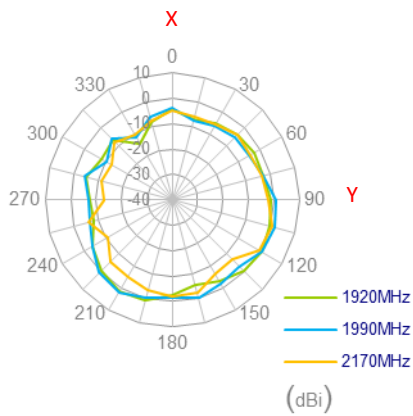

XZ Plane

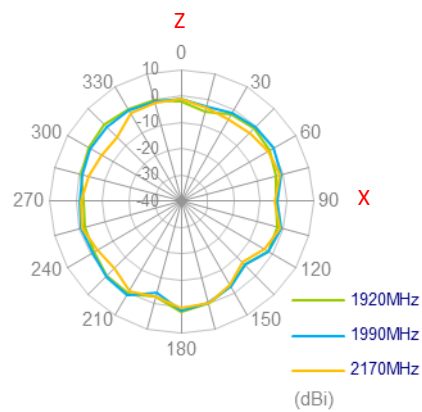

YZ Plane

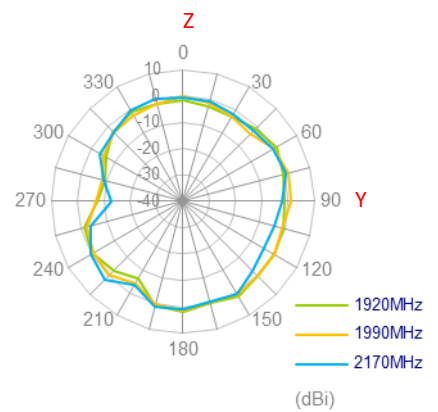

2500MHz

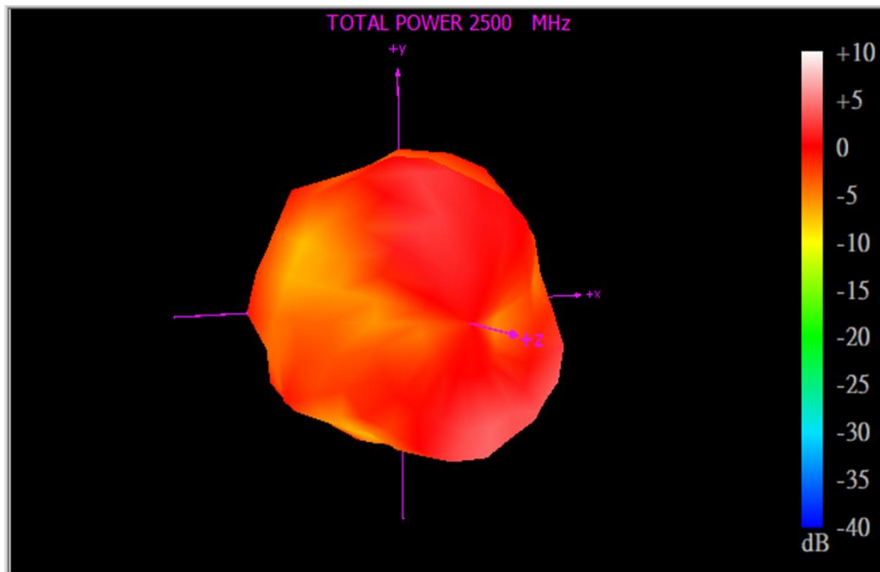

XY Plane

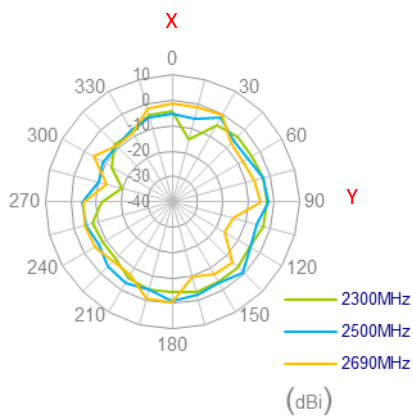

XZ Plane

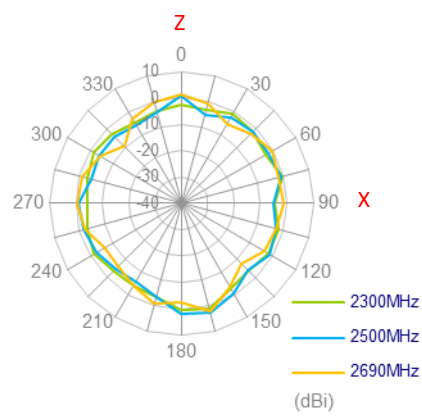

YZ Plane

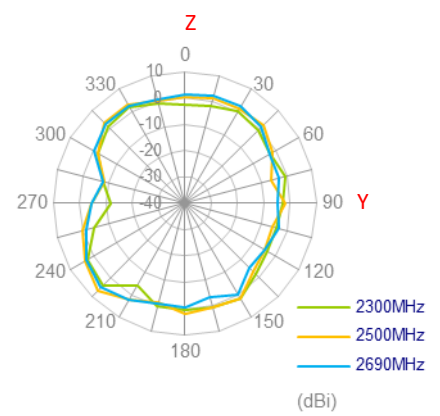

3550MHz

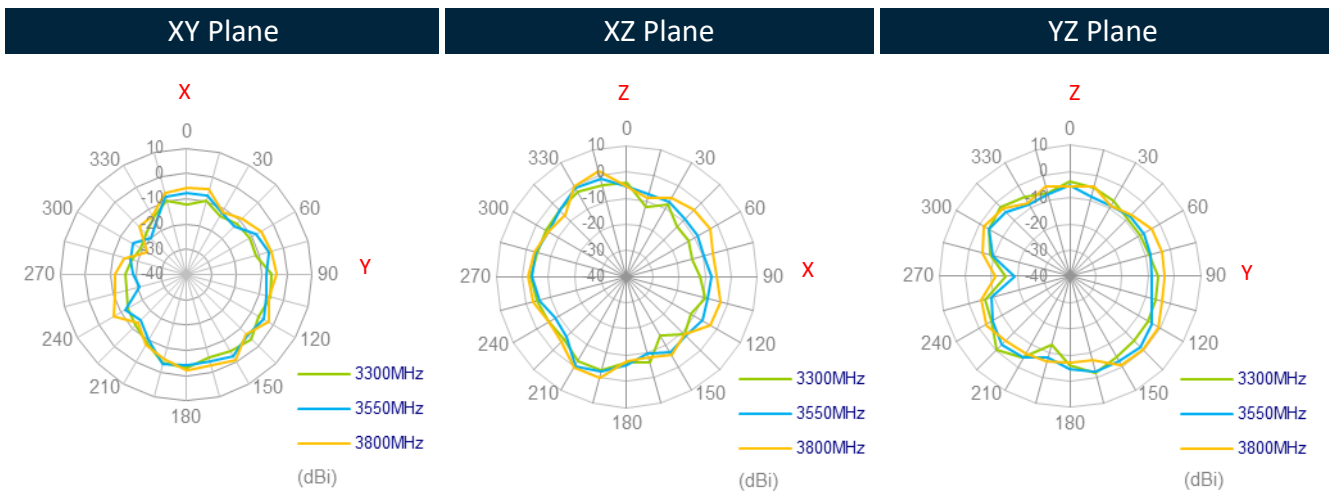
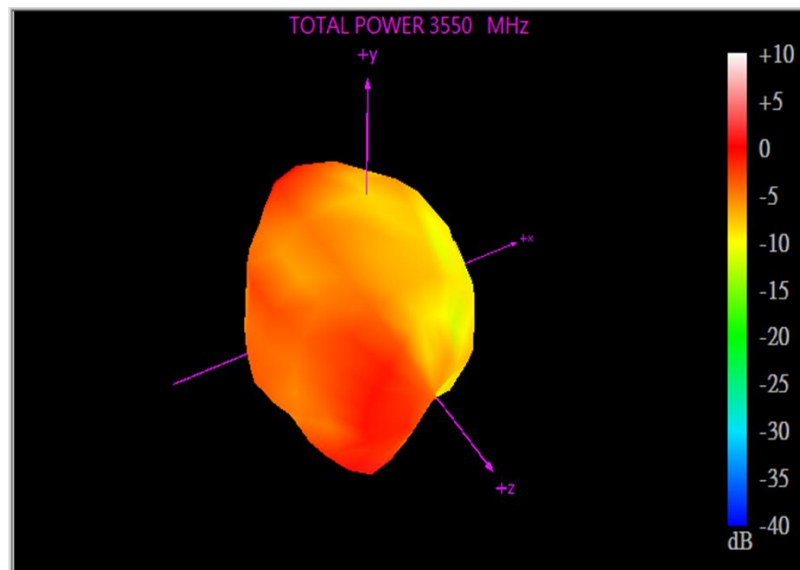

5550MHz

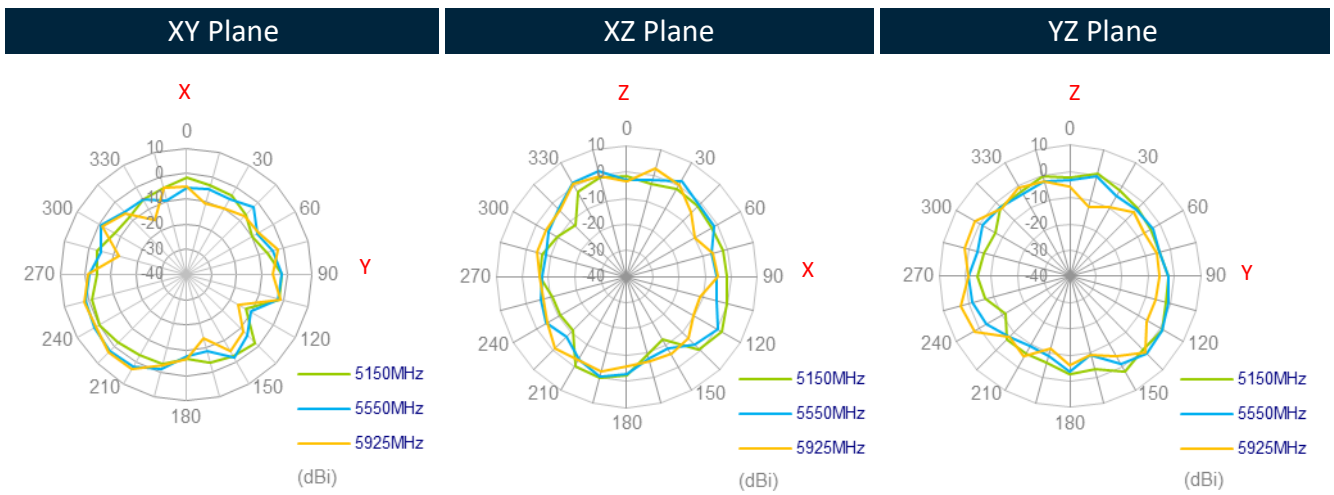
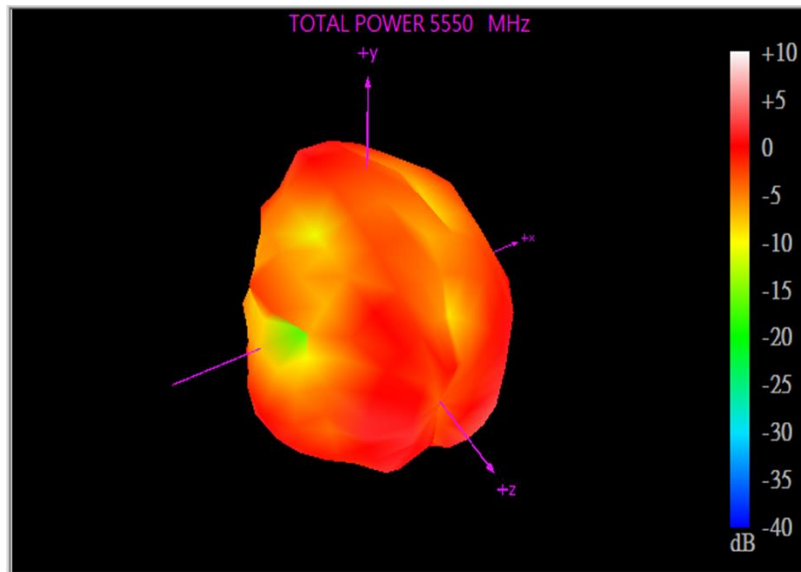

5.6 Wi-Fi MIMO1 Radiation Pattern

2450MHz

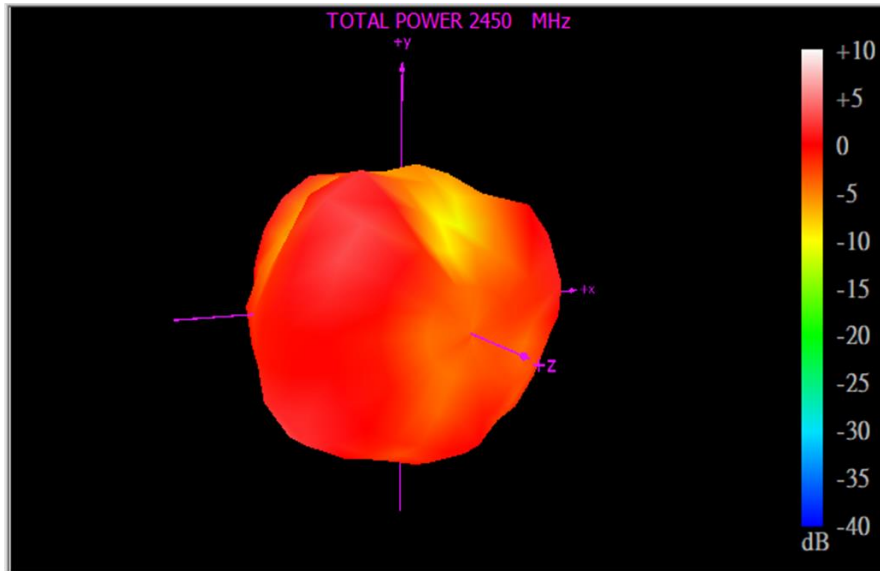

XY Plane

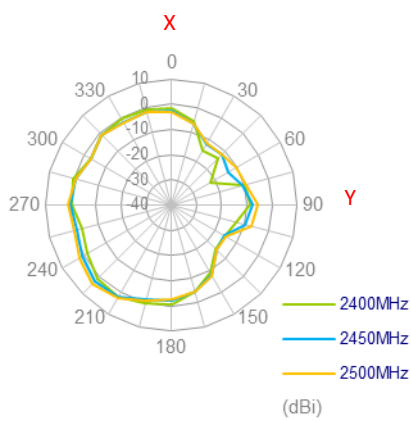

XZ Plane

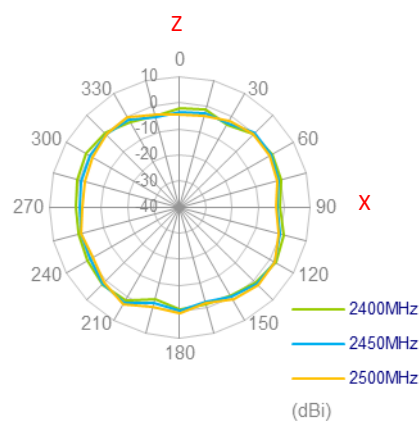

YZ Plane

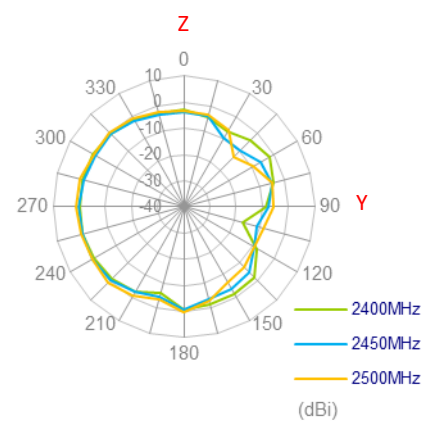

5550MHz

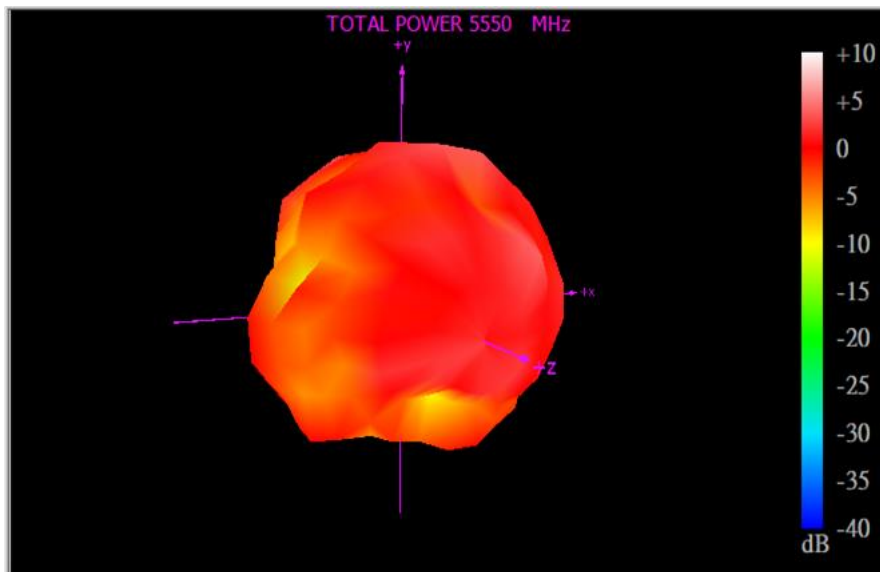

XY Plane

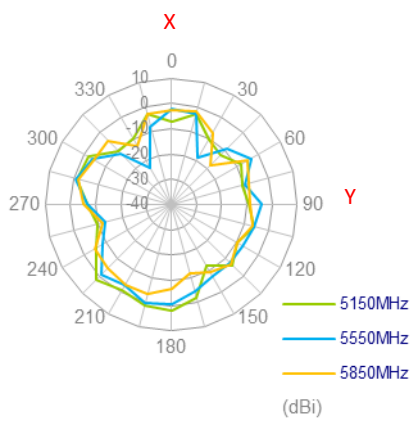

XZ Plane

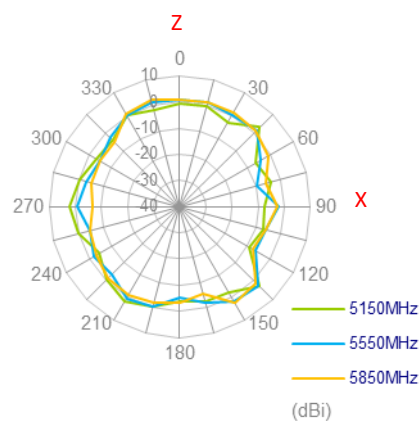

YZ Plane

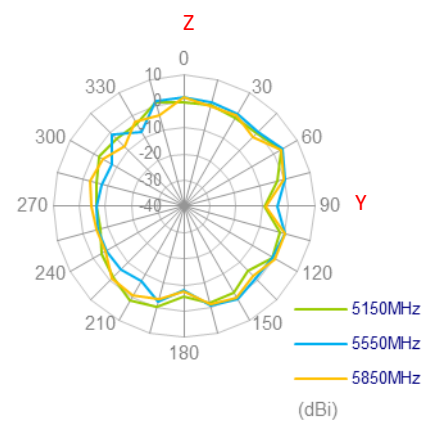

5.7 Wi-Fi MIMO2 Radiation Pattern

2450MHz

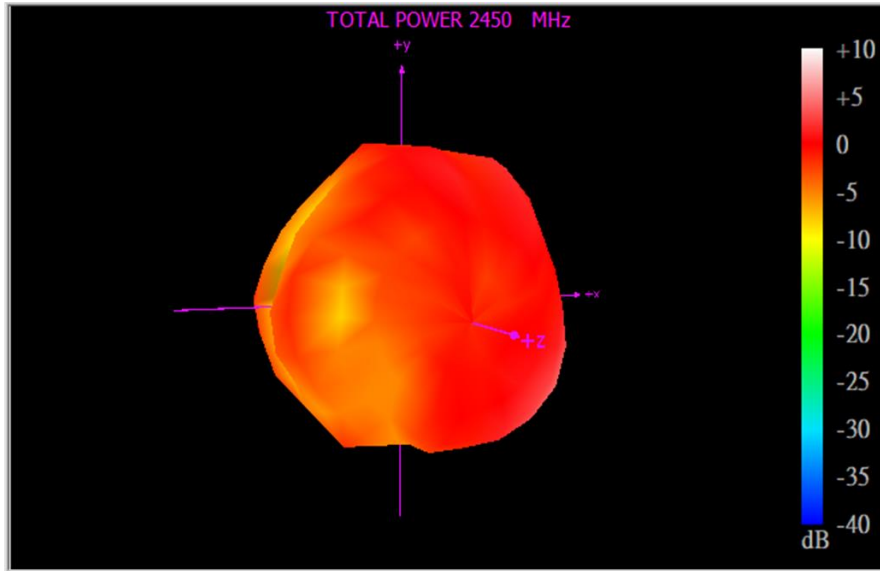

XY Plane

XZ Plane

YZ Plane

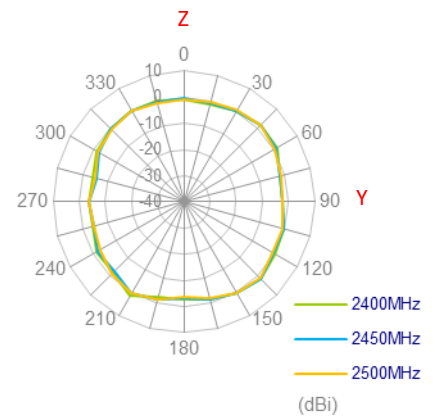
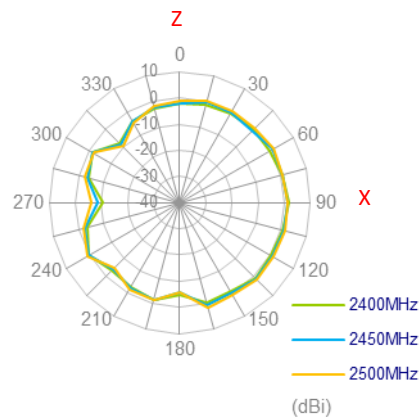
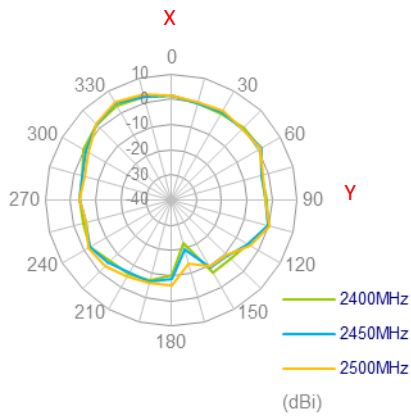

5550MHz

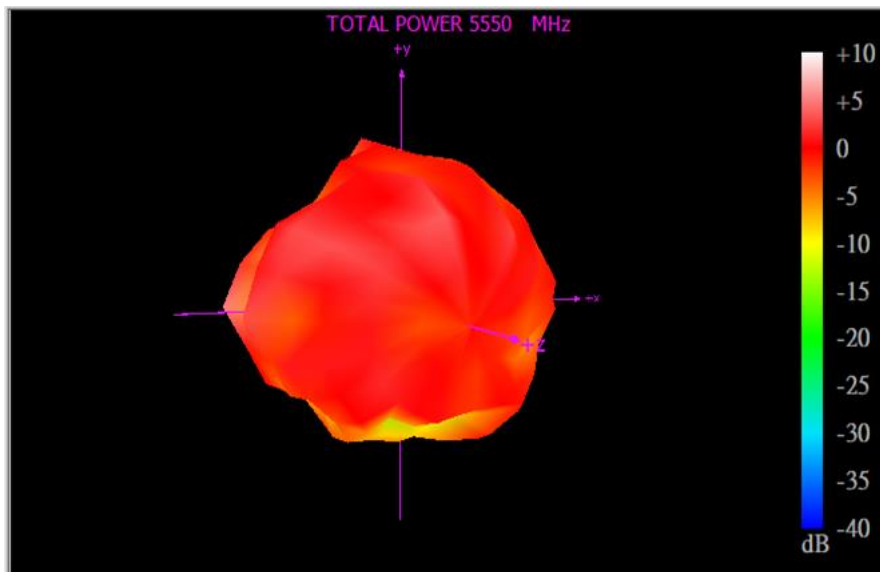

XY Plane

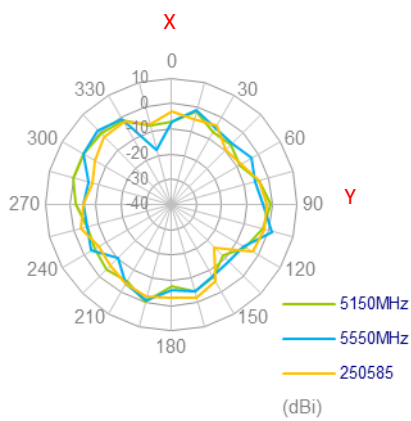

XZ Plane

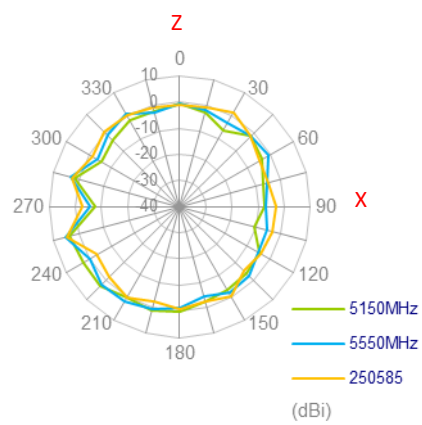

YZ Plane

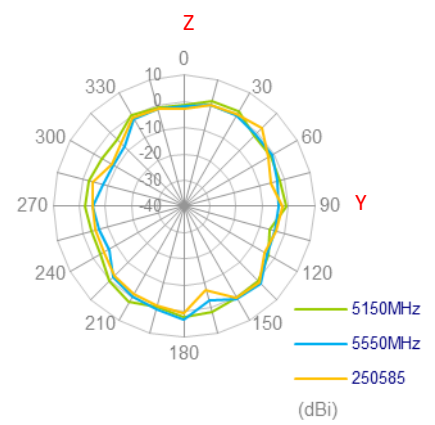

5.8 Wi-Fi MIMO3 Radiation Pattern

2450MHz

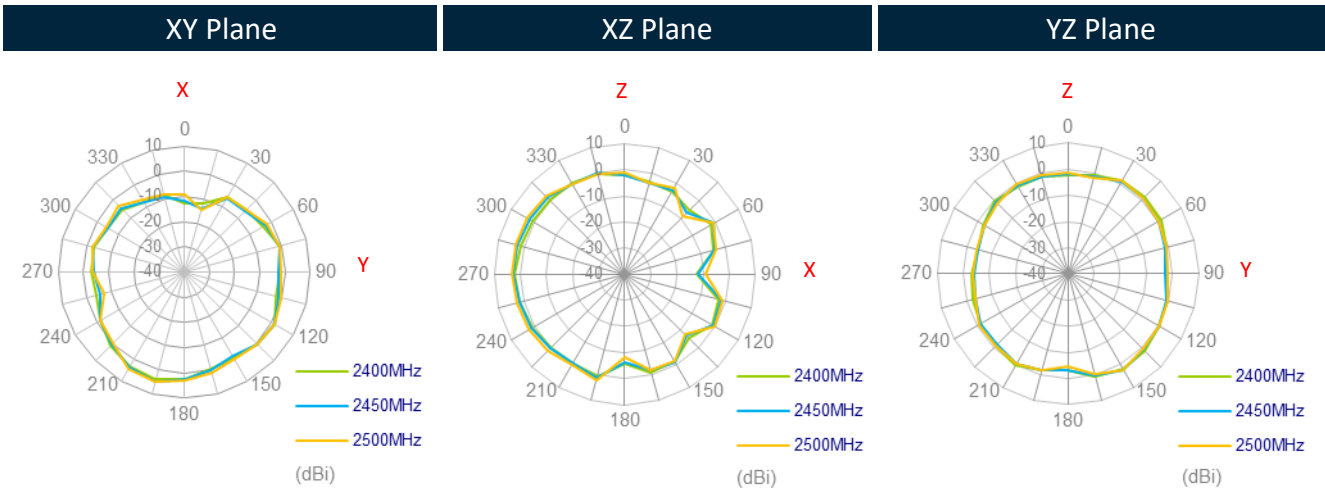
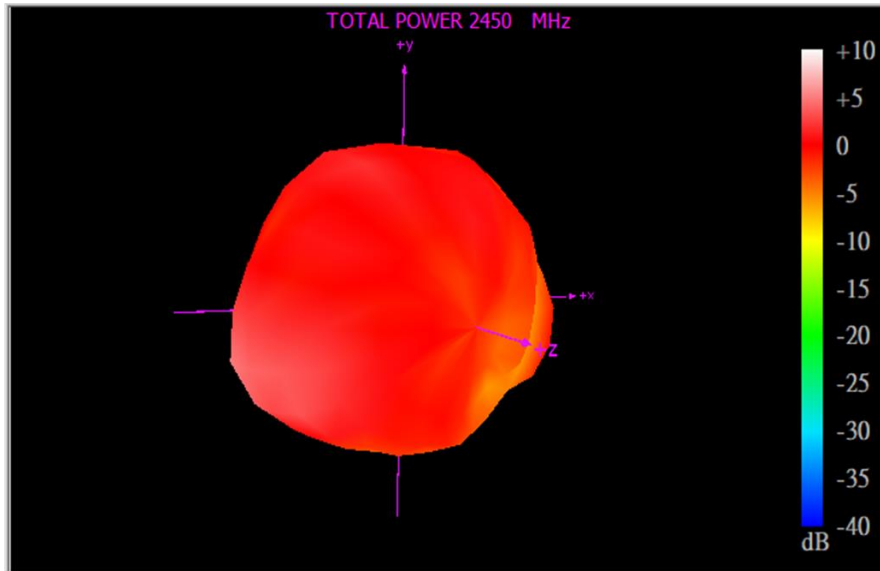

5550MHz

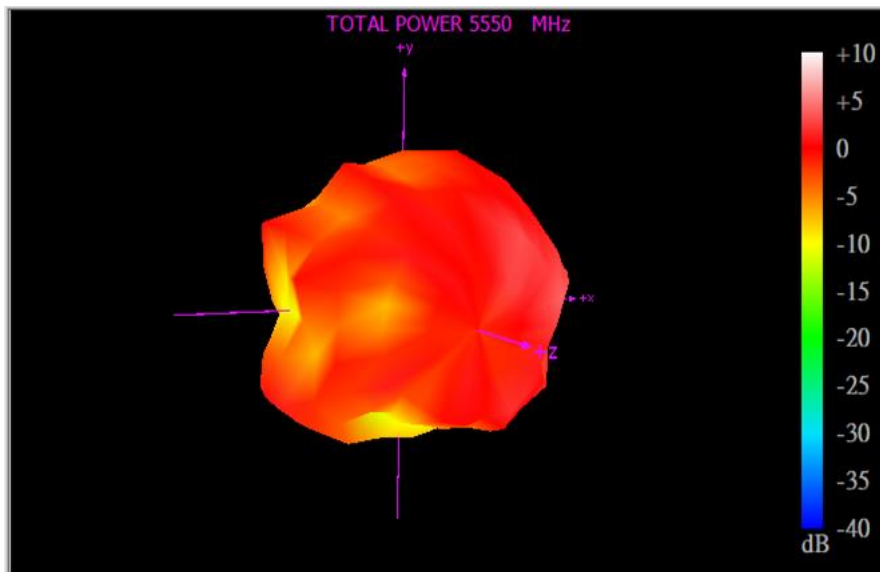

XY Plane

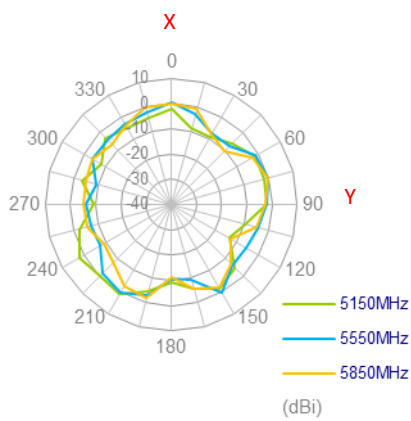

XZ Plane

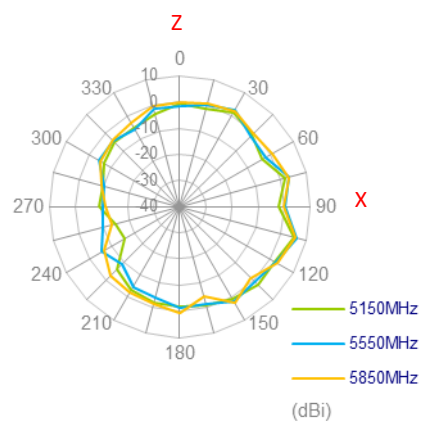

YZ Plane

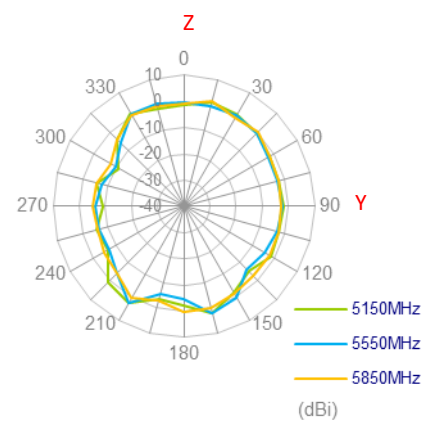

6. Mechanical Drawing (Units: mm)

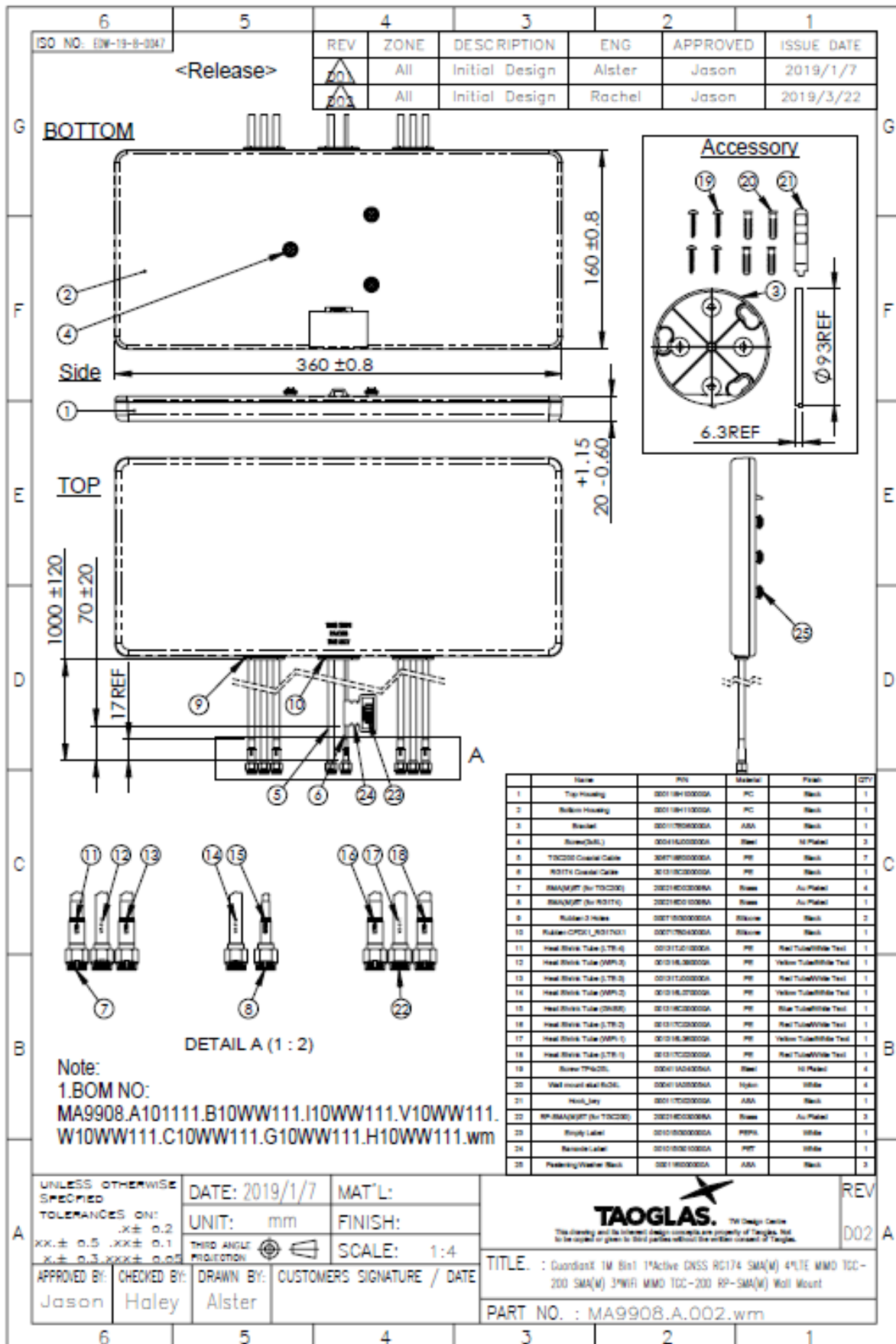

7. Packaging

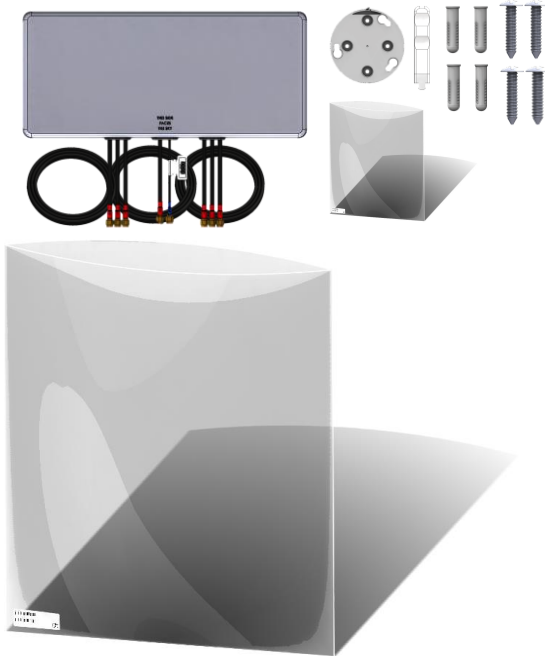

- (Antenna x1)/ Big PE bag
- Screw TP4x25L x4 /
/Wall Mount Stud 6x24L x4 / Hook Key x1
- SPQ Label
- "O" / "8" Shape Cable Winding

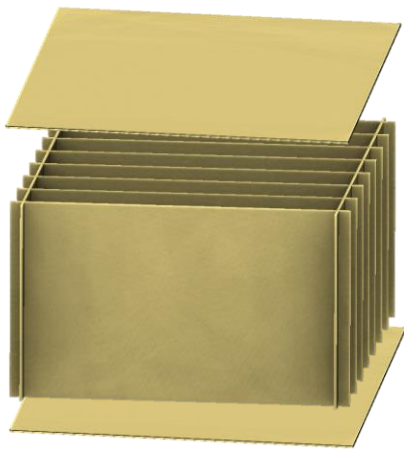

- 7PCS/ Carton
- Honeycomb Board 1 set
- Partition Board x 2
- Carton Label

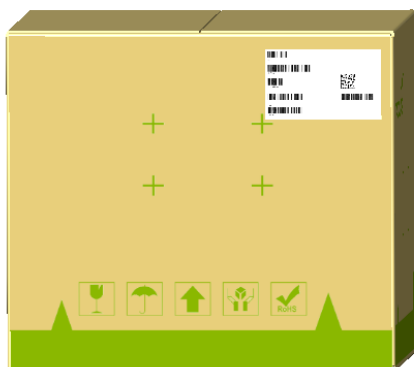

Changelog for the datasheet

SPE-19-8-078 – MA9908.A.002.wm

Revision: A (Original First Release)

Date: 2019-06-25

Notes:

Author: Jack Conroy

Previous Revisions



TAOGLAS®

www.taoglas.com

