

# Adhesive Mount MiMo LTE MiMo WiFi GNSS Antenna

BATGM-7-60[-24-58]



## Adhesive Mount MiMo 4G/5G Antenna with optional GPS/GNSS & / (MiMo) WiFi

- Mount on or under dashboard or any non-metallic surface
- 2x MiMo 4G/5G functionality
- Optional SiSo or MiMo WiFi 6e 2.4/5.0-7.2GHz
- Optional GPS/GNSS 26dB LNA

The Panorama BAT range is designed for Telematics applications requiring high speed data with MiMo 4G / 5G and fallback 3G/2G support along with optional positioning through GPS/GNSS, and optional dual band 2.4/5.0-7.2GHz Wifi 6e.

The dual 4G/5G antennas cover 617-960/1427-6000MHz and the efficient element design ensures an ongoing, robust communications link with high data rates even in many low coverage areas.

The antenna is designed to be mounted on or under a vehicle dashboard but can be mounted on any non-conductive surface. The BAT range is supplied with up to five integrated low loss cables which are flame retardant and meet the requirements of UN ECE 118 and EN45545-2

### Technical Drawing

BATGM-7-60[-24-58] Shown

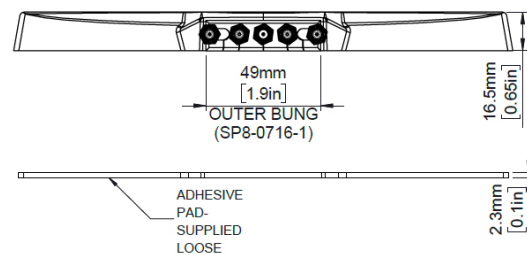
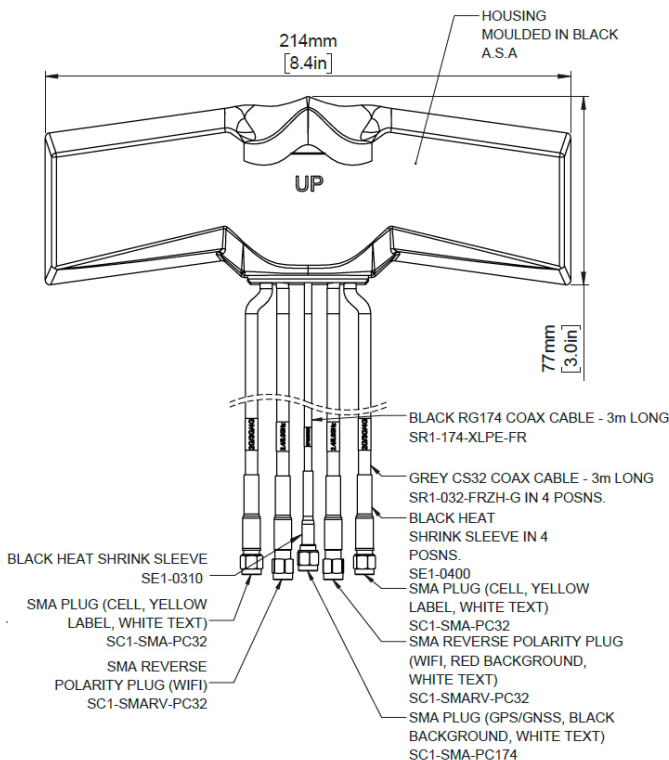

# Adhesive Mount MiMo LTE MiMo WiFi GNSS Antenna

## BATGM-7-60[-24-58]

### Product Data

Part No.	BATGM-7-60-24-58	BATGM-7-60-S24-58	BATGM-7-60	BATM-7-60
<b>Electrical Data</b>				
Frequency Range (MHz)	Elements 1&2	617-960/1427-6000		
	Element 3	1562-1612MHz		-
	Elements 4 (& 5)	2.4/5.0-7.2GHz		-
Peak Gain†	Elements 1&2	2dBi (617-960MHz) / 3dBi (1710-2170MHz) / 6dBi (2500-3800MHz) / 7dBi (4.9-60GHz)		
	Element 4 (& 5)	4dBi (2.4GHz) / 6dBi (5.0GHz) / 4dBi (6.0-7.2GHz)		-
Typical VSWR*	Elements 1&2	<2:1		-
	Element 4 (&5)	<2.5:1		-
Typical Efficiency**	Elements 1&2	>60%		-
	Element 4 (&5)	>55% (2.4GHz)   >70% (5.0GHz)		-
Typical Isolation*	Elements 1&2	<10dB		-
	Elements 4&5	<17dB		-
Pattern	Omnidirectional			
Impedance	50 Ohms			
Max input power (W)	20			
<b>GPS/GNSS Data</b>				
Frequency Range (MHz)	1559-1612MHz		-	
LNA Peak Gain	26dB		-	
Typical Out of Band Rejection	>40dB (+/- 100MHz f)		-	
Notch filter Rejection @787MHz	23dBm		-	
Typical Voltage	3-5VDC <20ma		-	
<b>Mechanical Data</b>				
Dimensions (mm)	Length	214 (8.4")		
	Width	77 (3")		
	Height	16.5 (0.65")		
Operating Temp (°C)	-30° / +70°C (-30° / 158°F)			
Material	ASA			
Colour	Black			
<b>Mounting Data</b>				
Fixing	Adhesive pad			
<b>Cable Data</b>		Elements 1&2 (Cell)	Element 3(GPS)	Elements 4&5 (WiFi) [if present]
Cable Type	CS32 (meets UN ECE 118 and EN45545-2)	FR RG174 (meets UN ECE 118 and EN45545-2)	CS32 (meets UN ECE 118 and EN45545-2)	
Diameter (mm)	5 (0.2")	2.8 (0.1")	5 (0.2")	
Length (m)	3 (10')	3 (10')	3 (10')	
<b>Termination</b>				
BATGM-7-60-24-58	2x SMA Plug (m)	SMA Plug (m)	2x Rev Pol SMA Plug	
BATGM-7-60-S24-58	2x SMA Plug (m)	SMA Plug (m)	1x Rev Pol SMA Plug	
BATGM-7-60	2x SMA Plug (m)	SMA Plug (m)	-	
BATM-7-60	2x SMA Plug (m)	-	-	

† Peak gain derived from CST Microwave Studio for each element fed individually and excludes cable loss.

\*Typical Isolation and VSWR measured with 3m(10') of CS32 cable on 3mm plastic sheet.

\*\*Efficiency simulated in CST Microwave Studio and excludes cable loss

Electrical Data

Typical VSWR - Elements 1&2\*

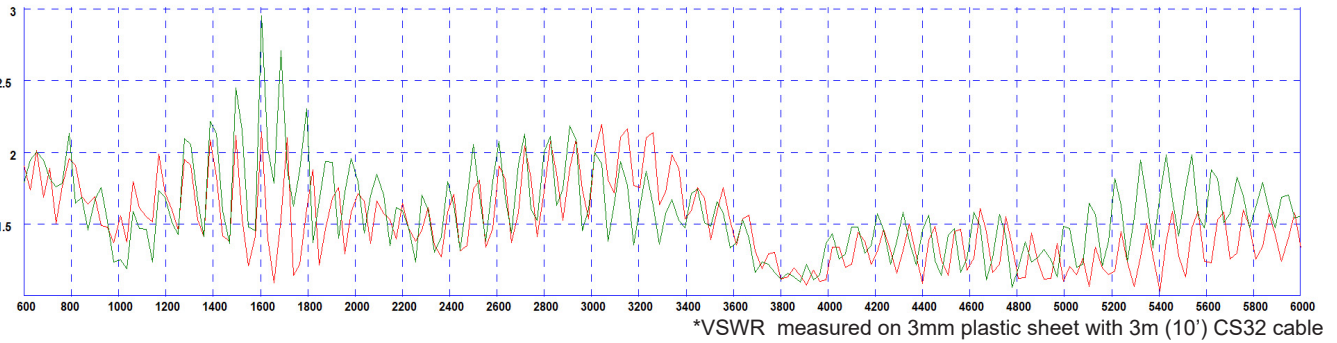

Typical VSWR - Elements 4&5\*

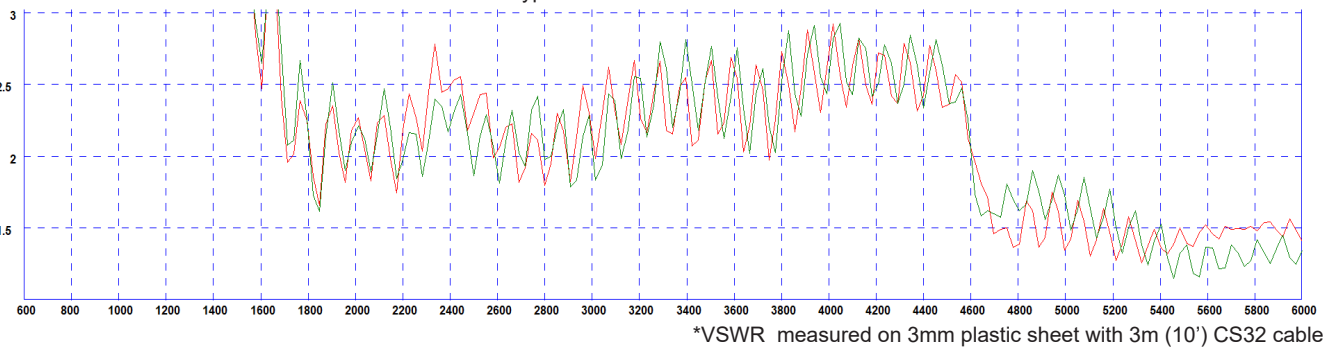

Typical Isolation - 4G/5G Elements 1-2 \*

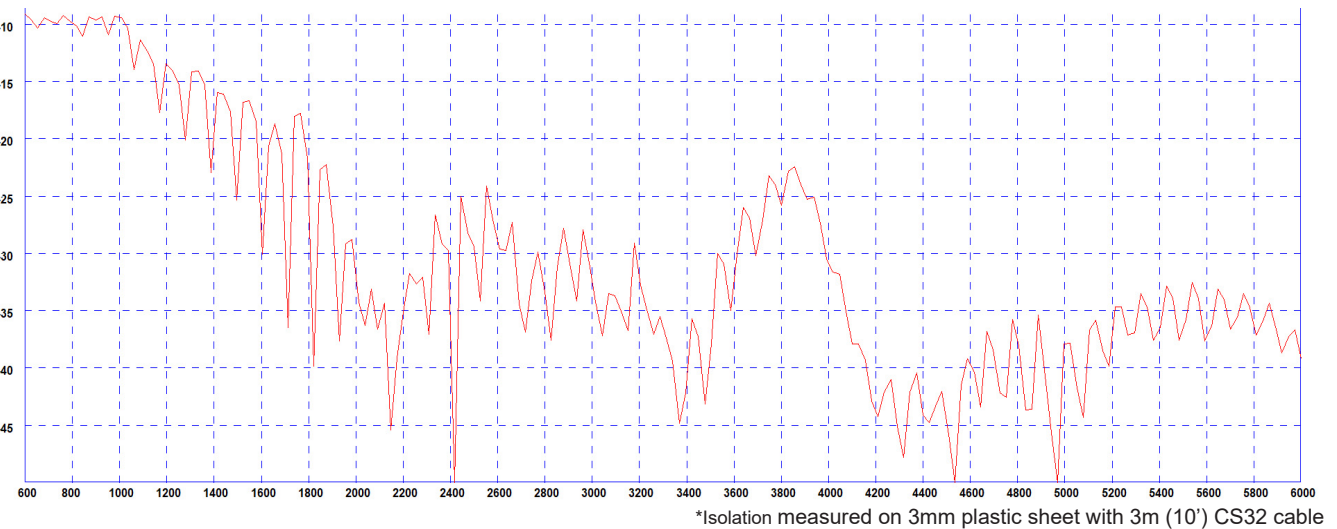

Typical Isolation - WiFi Elements 4-5\*

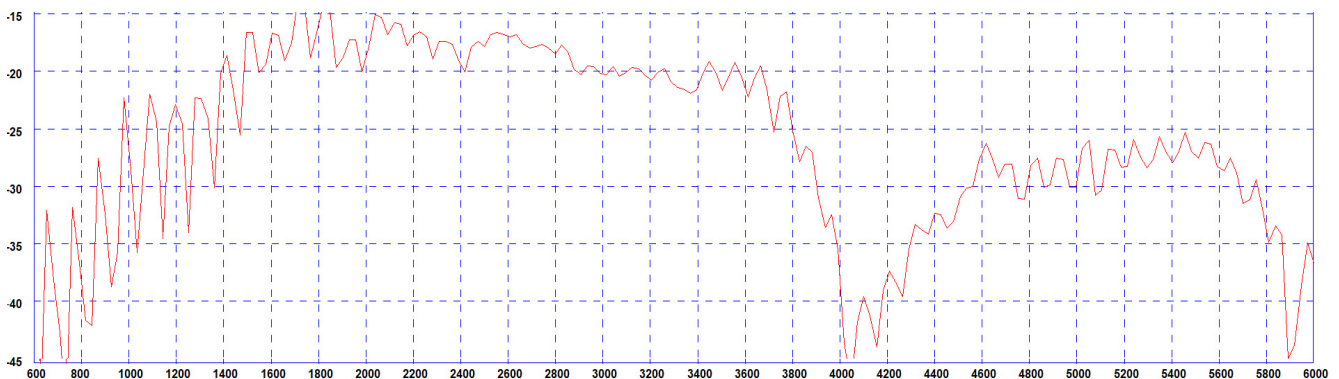

3D Patterns Cell

3D Pattern Element 1 (650MHz)

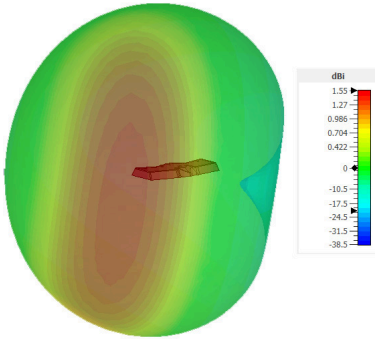

3D Pattern Element 2 (650MHz)

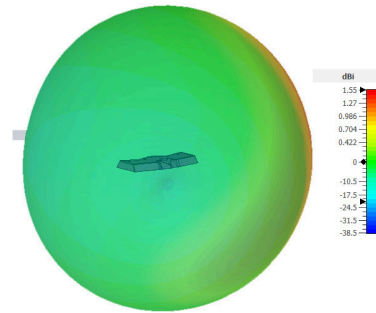

3D Pattern Element 1 (750MHz)

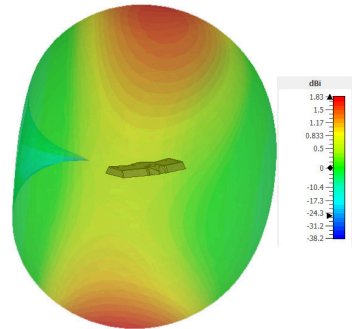

3D Pattern Element 2 (750MHz)

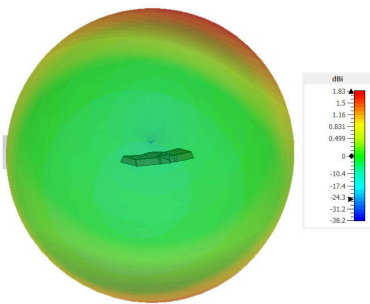

3D Pattern Element 1 (850MHz)

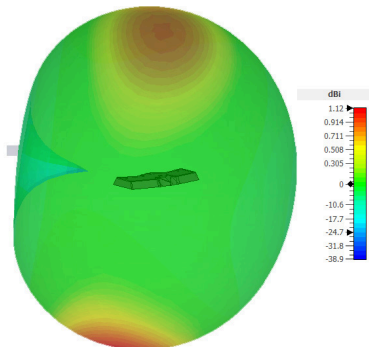

3D Pattern Element 2 (850MHz)

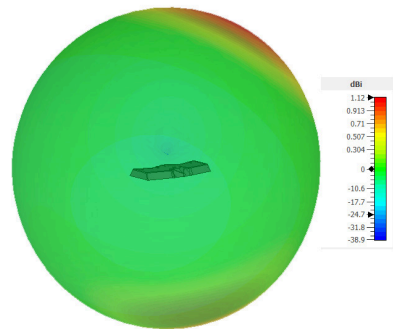

3D Pattern Element 1 (1800MHz)

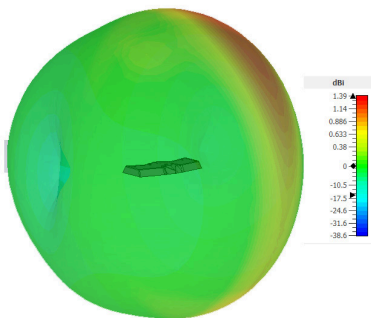

3D Pattern Element 2 (1800MHz)

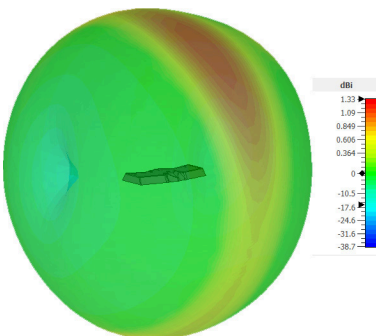

3D Pattern Element 1 (2600MHz)

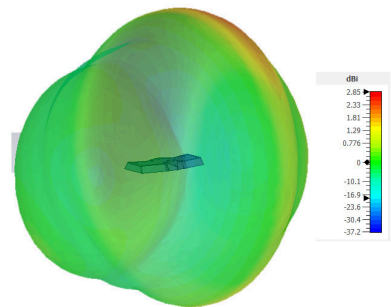

3D Pattern Element 2 (2600MHz)

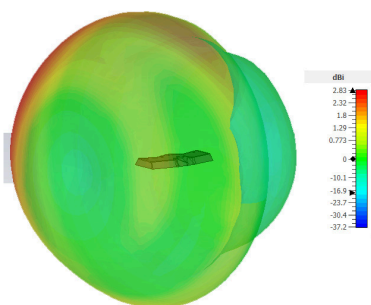

3D Pattern Element 1 (3500MHz)

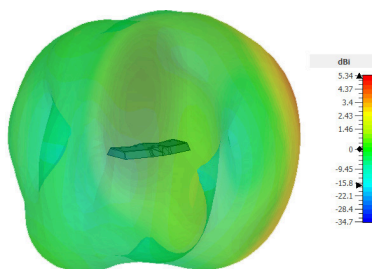

3D Pattern Element 2 (3500MHz)

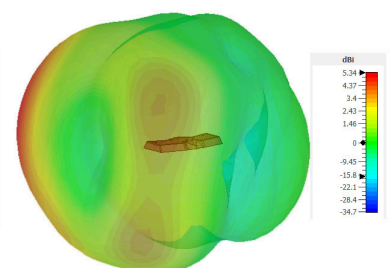

3D patterns derived from CST Microwave Studio in free space for each element fed individually and excludes cable loss.



## 3D Patterns WiFi

3D Pattern Element 1 (2450MHz)

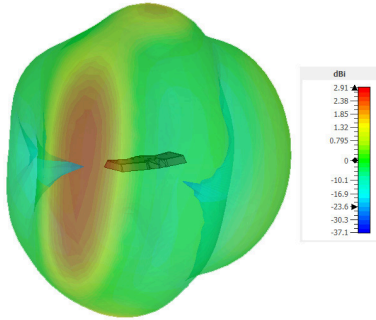

3D Pattern Element 2 (2450MHz)

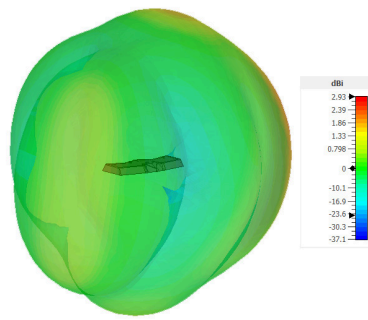

3D Pattern Element 1 (5400MHz)

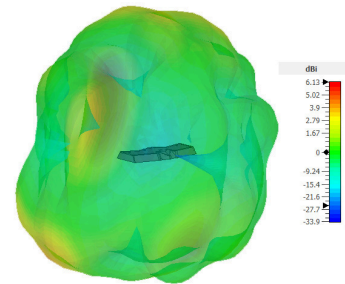

3D Pattern Element 2 (5400MHz)

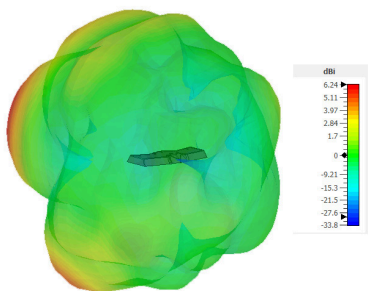

3D Pattern Element 1 (7100MHz)

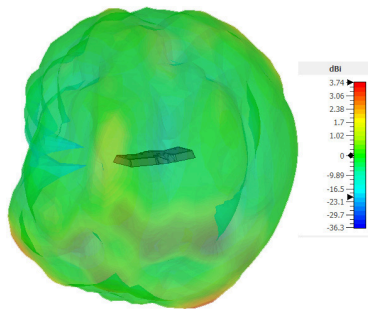

3D Pattern Element 2 (7100MHz)

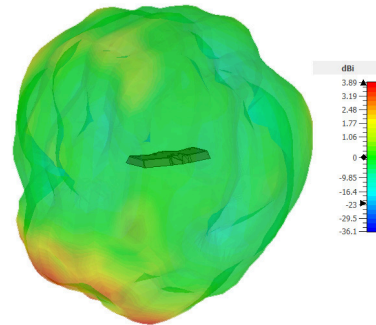

3D patterns derived from CST Microwave Studio in free space for each element fed individually and excludes cable loss.