

# UC51x Series

User Guide

## Safety Precautions

Milesight will not shoulder responsibility for any loss or damage resulting from not following the instructions of this operating guide.

- ❖ The device must not be remodeled in any way.
- ❖ Do not place the device close to objects with naked flames.
- ❖ Do not place the device where the temperature is below/above the operating range.
- ❖ Make sure electronic components do not drop out of the enclosure while opening.
- ❖ When installing the battery, please install it accurately, and do not install the reverse or wrong model.
- ❖ The device must never be subjected to shocks or impacts.

## Declaration of Conformity

UC51x series is in conformity with the essential requirements and other relevant provisions of the CE, FCC, and RoHS.



Copyright©2011-2021 Milesight. All rights reserved.

All information in this guide is protected by copyright law. Whereby, no organization or individual shall copy or reproduce the whole or part of this user guide by any means without written authorization from Xiamen Milesight IoT Co., Ltd.

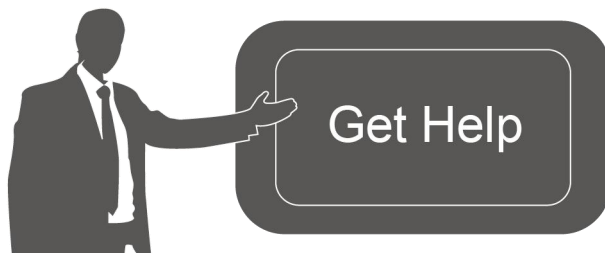

For assistance, please contact

Milesight technical support:

Email: [iot.support@milesight.com](mailto:iot.support@milesight.com)

Tel: 86-592-5085280

Fax: 86-592-5023065

Address: 4/F, No.63-2 Wanghai Road,  
2<sup>nd</sup> Software Park, Xiamen, China

## Revision History

Date	Doc Version	Description
Feb. 20, 2021	V 1.0	Initial version

# Contents

1. Product Introduction.....	4
1.1 Overview.....	4
1.2 Features.....	4
2. Hardware Introduction.....	4
2.1 Packing List.....	4
2.2 Hardware Overview.....	5
2.3 Power Button.....	5
2.4 Dimensions(mm).....	6
3. Installation.....	6
4. Operation Guide.....	8
4.1 Log in the ToolBox.....	8
4.1.1 NFC Configuration.....	8
4.1.2 USB Configuration.....	9
4.2 Solenoid Valve Control.....	10
4.3 LoRaWAN Settings.....	11
4.4 Solenoid Settings.....	14
4.5 Maintenance.....	15
4.5.1 Upgrade.....	15
4.5.2 Backup.....	16
4.5.3 Reset to Factory Default.....	17
5. Milesight IoT Cloud Management.....	18
5.1 Add a Milesight Gateway.....	18
5.2 Add UC51x to Milesight IoT Cloud.....	19
5.3 Solenoid Valve Control.....	21
6. Device Payload.....	22

# 1. Product Introduction

## 1.1 Overview

UC51x series LoRaWAN® wireless solenoid valve controller is a device used to remotely control DC latching solenoids of the valve. It contains 2 solenoid interfaces and 1 pulse interface, which can be easily controlled locally or remotely.

Besides ultra-low-power LoRaWAN® technology, UC51x series also provides both solar and built-in battery power supply for uninterrupted operation. For outdoor applications, it equips with IP67-rated enclosure and M12 connectors to protect from water and dust under harsh environments.

## 1.2 Features

- Compatible with standard DC latching solenoids
- OPEN/CLOSE control by mobile APP locally or commands remotely
- One pulse water meter interface for flow monitoring
- Transmission distance up to 11km with line of sight
- Waterproof design including IP67 case and M12 connectors
- Solar powered and built-in chargeable battery
- Quick wireless configuration via NFC
- Time and flow control via Milesight IoT Cloud

# 2. Hardware Introduction

## 2.1 Packing List

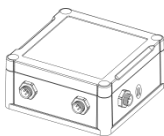

1 × U51x Device

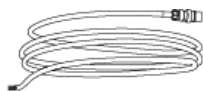

3 × Data Cables  
(1.5m)

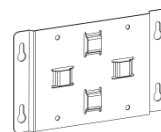

1 × Mounting  
Bracket



Wall Mounting Kits



1 × Warranty Card



1 × Quick Guide

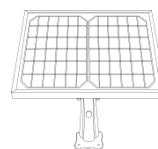

1 × Solar Panel Kit  
(UC511 Optional)



2 × Hose Clamps  
(Optional)

**⚠** If any of the above items is missing or damaged, please contact your sales Representative.

## 2.2 Hardware Overview

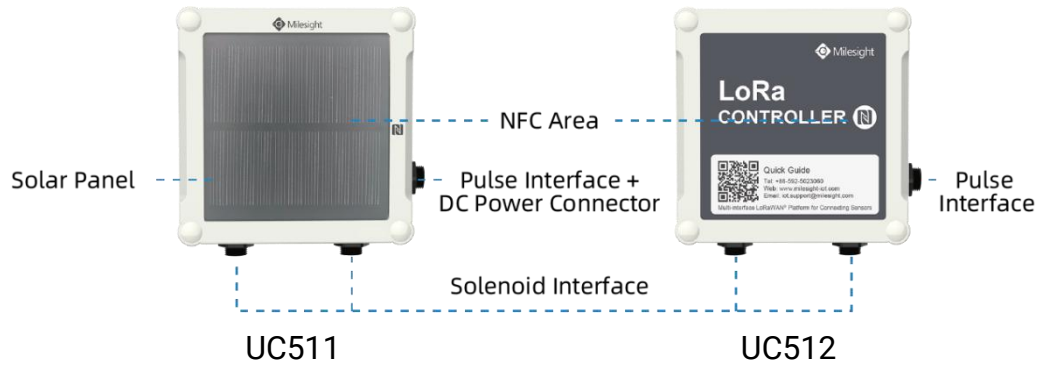

### Solenoid Interfaces:

Pin	Description
1	GND
2	GPIO(for wiring switch)
3	CLOSE(Black)
4	OPEN(Red)

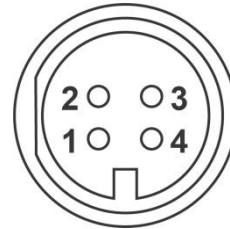

### Pulse Interface/DC:

Pin	Description
1	GPIO2
2	VCC(5-24V)
3	GND
4	GPIO1
5	GND
6	GND

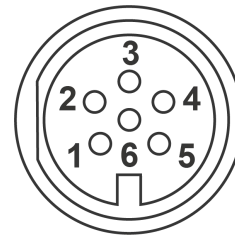

## 2.3 Power Button

Function	Action	LED Indication
Turn On	Press and hold the button for more than 3s.	Off → On
Turn Off	Press and hold the button for more than 3s.	On → Off
Reset	Press and hold the button for more than 10s.	Blinks.
Check On/Off Status	Quickly press the power button.	Light On: Device is on. Light Off: Device is off.

## 2.4 Dimensions(mm)

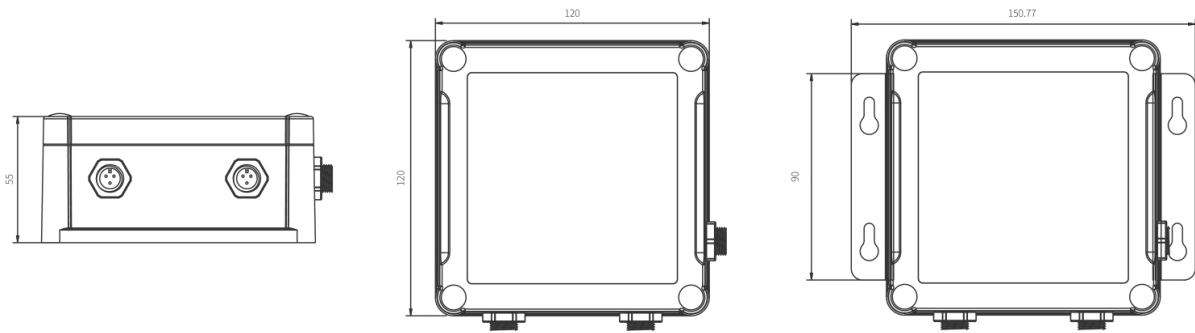

## 3. Installation

### Wall Mounting

Make sure you have wall mounting bracket, bracket mounting screws, wall plugs, wall mounting screws and other required tools.

#### Steps:

1. Mount the enclosure to the mounting bracket with the bracket mounting screws.

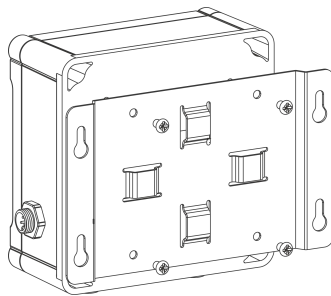

2. Align the mounting bracket horizontally to the desired position on the wall, use a marker pen to mark four mounting holes on the wall, and then remove the mounting bracket from the wall.

**Note:** The connecting lines of adjacent points are at right angles.

3. Drill the four holes by using your drill with a 6 mm drill bit on the positions you marked previously on the wall.
4. Insert four wall plugs into the holes respectively.
5. Mount the mounting bracket horizontally to the wall by fixing the wall mounting screws into the wall plugs.

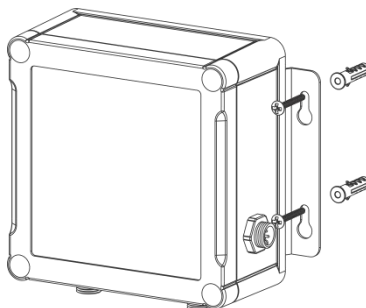

## Pole Mounting

Make sure you have wall mounting bracket, bracket mounting screws, hose clamp and other required tools.

### Steps:

1. Mount the enclosure to the mounting bracket with the bracket mounting screws.

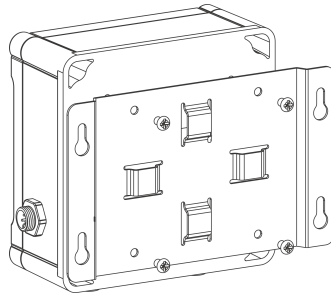

2. Loosen the hose clamp by turning the locking mechanism counter-clockwise.

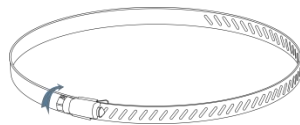

3. Straighten out the hose clamp and slide it through the rectangular holes in the mounting bracket, wrap the hose clamp around the pole.
4. Use a screwdriver to tighten the locking mechanism by turning it clockwise.

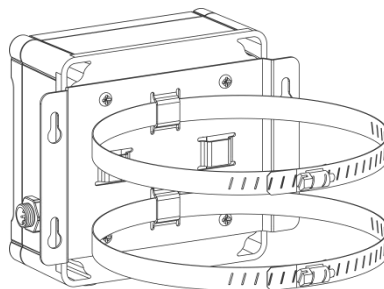

## 4. Operation Guide

### 4.1 Log in the ToolBox

UC51x series can be monitored and configured via ToolBox APP or ToolBox software. Please select one of them to complete configuration.

#### 4.1.1 NFC Configuration

##### Preparation:

- Smartphone (NFC supported)
- Milesight ToolBox App: V1.3.9 and above

##### Steps:

1. download and install from Google Play or Apple Store.
2. Enable NFC on the smartphone and open "Milesight ToolBox" APP.
3. Attach the smartphone with NFC area to the device to read basic information.

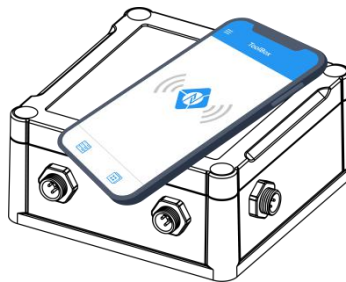

4. Basic information and settings of devices will be shown on ToolBox if it's recognized successfully. You can turn on/off the device by tapping the button on the Device Status. In order to protect the security of devices, password validation is required when configuring via unused phone . Default password is **123456**.

Status	Setting	Reset
SN	6415A51585070020	
Model	UC512-DI-868M	
Device EUI	24e124415a515850	
Firmware Version	V1.8	
Hardware Version	V1.0	
Device Status	Off	<input type="checkbox"/>

Read

Device Template



5. Tap “Read” button to check current status of device.
6. Tap “Write” button to write all your settings to the device.

**Note:**

- 1) Ensure the location of smartphone NFC area and it’s recommended to take off phone case.
- 2) If the smartphone fails to read/write configurations via NFC, keep the phone away and back to try again.
- 3) UC51x series can also be configured by dedicated NFC reader, which can be purchased from Milesight IoT.

### 4.1.2 USB Configuration

**Preparation:**

- Type-C USB cable
- PC (Windows 10 is recommended)
- ToolBox: V6.35 and above

**Steps:**

1. Download ToolBox from Milesight IoT website.
2. Open the case of UC51x and connect the UC51x to computer via type-C port.

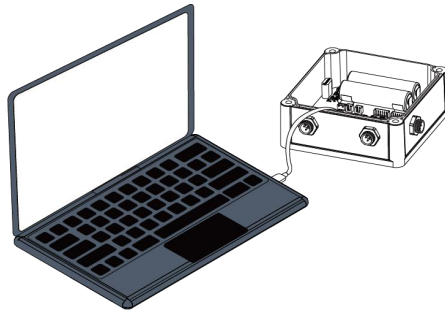

3. Open the ToolBox and select type as “General”, then click password to log in ToolBox.  
(Default password: **123456**)

A screenshot of a software dialog box titled "ToolBox Settings". The dialog has a blue header bar with a close button (X). The settings are as follows:

Type	General
Serial port	COM4
Login password	
Baud rate	115200
Data bits	8
Parity bits	None
Stop bits	1

At the bottom of the dialog are two buttons: "Save" and "Cancel".

4. After logging in the ToolBox, you can click “Power On” or “Power Off” to turn on/off device and change other settings.

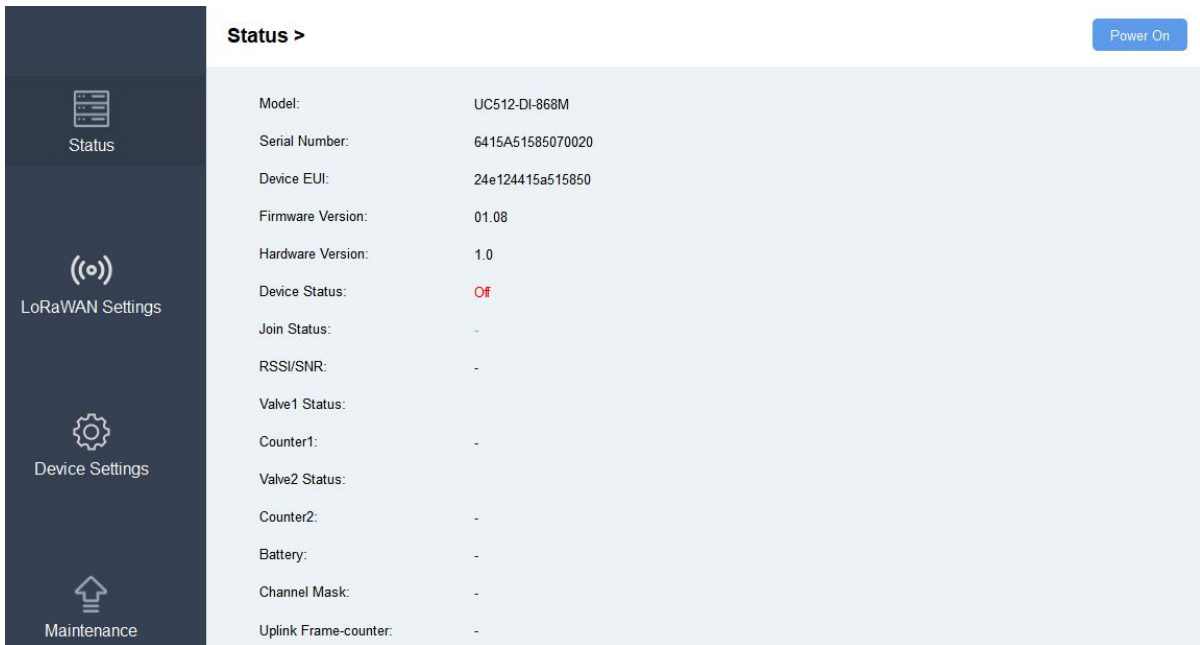

## 4.2 Solenoid Valve Control

Solenoid valve can be controlled by ToolBox App or ToolBox software locally.

### Via ToolBox Software:

Click “Open” or “Close” button on the “Status” page to change the status of solenoid valves.



### Via ToolBox App:

Click buttons of Valve Status on the “Device->Status” page, then attach the smart phone to device to change the status of solenoid valves.

Status	Setting	Reset
Hardware Version		V1.0
Device Status	ON	
Join Status	Activated	
RSSI/SNR		-35/15
Device Time	2021-02-04 10:35	<a href="#">Sync</a>
Valve 1 Status	Off	
Counter 1		0
Valve 2 Status	On	
Counter 2		0
Battery		100%

## 4.3 LoRaWAN Settings

LoRaWAN settings is used for configuring the transmission parameters in LoRaWAN® network.

Step 1: Go to “**LoRaWAN -> Basic**” of ToolBox software or “**Setting->LoRaWAN Settings**” of ToolBox App to configure join type, App EUI, App Key and other information. You can also keep all settings by default.

Device EUI	<input type="text" value="24E124415A515850"/>
App EUI	<input type="text" value="24E124C0002A0001"/>
Application Port	<input type="text" value="85"/>
Join Type	<input type="text" value="OTAA"/>
LoRaWAN Version	<input type="text" value="V1.1.0"/>
Application Key	<input type="text" value="*****"/>
Spread Factor	<input type="text" value="SF10-DR2"/>
Confirmed Mode	<input type="checkbox"/>
Rejoin Mode	<input checked="" type="checkbox"/>
Set the number of packets sent	<input type="text" value="32"/> packets
ADR Mode	<input checked="" type="checkbox"/>
TXPower	<input type="text" value="TXPower0-16 dBm"/>

Parameters	Description
Device EUI	Unique ID of the device which can also be found on the label.
App EUI	Default App EUI is 24E124C0002A001.
Application Port	The port used for sending and receiving data, default port is 85.
Join Type	OTAA and ABP mode are available.
LoRaWAN Version	V1.0.2, V1.0.3, V1.1 are available.
Application Key	Appkey for OTAA mode, default is 5572404C696E6B4C6F52613230313823.
Device Address	DevAddr for ABP mode, default is the 5 <sup>th</sup> to 12 <sup>th</sup> digits of SN.
Network Session Key	Nwkskey for ABP mode, default is 5572404C696E6B4C6F52613230313823.
Application Session Key	Appskey for ABP mode, default is 5572404C696E6B4C6F52613230313823.
Spread Factor	If ADR is disabled, the device will send data via this spread factor.
Confirmed Mode	If the device does not receive ACK packet from network server, it will resend data 3 times at most.
Rejoin Mode	Reporting interval $\leq$ 30 mins: device will send specific mounts of LoRaMAC packets to check connection status every 30 mins; If no reply after specific packets, the device will re-join. Reporting interval $>$ 30 mins: device will send specific mounts of LoRaMAC packets every to check connection status every reporting interval; If no reply after specific packets, the device will re-join.
ADR Mode	Allow network server to adjust datarate of the device.
Tx Power	Based on LoRaWAN <sup>®</sup> regional parameter document.

**Note:**

- 1) Please contact sales for device EUI list if there are many units.
- 2) Please contact sales if you need random App keys before purchase.
- 3) Select OTAA mode if you use Milesight IoT cloud to manage devices.
- 4) Only OTAA mode supports rejoin mode.
- 5) For TTN connection please select LoRaWAN version as 1.0.2.

Step 2: Go to “**LoRaWAN -> Channel**” of ToolBox software or “**Setting->LoRaWAN Settings**” of ToolBox APP to select supported frequency and select channels to send uplinks. Make sure the channels match the LoRaWAN<sup>®</sup> gateway.

Basic
Channel

Support Frequency : EU868

<input type="checkbox"/>	Index	Frequency/MHz	Max Datarate	Min Datarate
<input checked="" type="checkbox"/>	0	<input style="width: 80px;" type="text" value="868.1"/>	<span style="border: 1px solid #ccc; padding: 2px 5px;">5-SF7BW125</span>	<span style="border: 1px solid #ccc; padding: 2px 5px;">0-SF12BW125</span>
<input checked="" type="checkbox"/>	1	<input style="width: 80px;" type="text" value="868.3"/>	<span style="border: 1px solid #ccc; padding: 2px 5px;">5-SF7BW125</span>	<span style="border: 1px solid #ccc; padding: 2px 5px;">0-SF12BW125</span>
<input checked="" type="checkbox"/>	2	<input style="width: 80px;" type="text" value="868.5"/>	<span style="border: 1px solid #ccc; padding: 2px 5px;">5-SF7BW125</span>	<span style="border: 1px solid #ccc; padding: 2px 5px;">0-SF12BW125</span>
<input type="checkbox"/>	3	<input style="width: 80px;" type="text" value="0"/>	<span style="border: 1px solid #ccc; padding: 2px 5px;">5-SF7BW125</span>	<span style="border: 1px solid #ccc; padding: 2px 5px;">0-SF12BW125</span>
<input type="checkbox"/>	4	<input style="width: 80px;" type="text" value="0"/>	<span style="border: 1px solid #ccc; padding: 2px 5px;">5-SF7BW125</span>	<span style="border: 1px solid #ccc; padding: 2px 5px;">0-SF12BW125</span>
<input type="checkbox"/>	5	<input style="width: 80px;" type="text" value="0"/>	<span style="border: 1px solid #ccc; padding: 2px 5px;">5-SF7BW125</span>	<span style="border: 1px solid #ccc; padding: 2px 5px;">0-SF12BW125</span>
<input type="checkbox"/>	6	<input style="width: 80px;" type="text" value="0"/>	<span style="border: 1px solid #ccc; padding: 2px 5px;">5-SF7BW125</span>	<span style="border: 1px solid #ccc; padding: 2px 5px;">0-SF12BW125</span>
<input type="checkbox"/>	7	<input style="width: 80px;" type="text" value="0"/>	<span style="border: 1px solid #ccc; padding: 2px 5px;">5-SF7BW125</span>	<span style="border: 1px solid #ccc; padding: 2px 5px;">0-SF12BW125</span>

If frequency is one of CN470/AU915/US915, you can enter the index of the channel that you want to enable in the input box, making them separated by commas.

**Examples:**

1, 40: Enabling Channel 1 and Channel 40

1-40: Enabling Channel 1 to Channel 40

1-40, 60: Enabling Channel 1 to Channel 40 and Channel 60

All: Enabling all channels

Null: Indicates that all channels are disabled

Support Frequency : AU915

Enabled Channel Index: 0-71

Channel Index	Frequency/MHz	Channel Spacing/MHz	BW/kHz
0 - 15	915.2 - 918.2	0.2	125
16 - 31	918.4 - 921.4	0.2	125
32 - 47	921.6 - 924.6	0.2	125
48 - 63	924.8 - 927.8	0.2	125
64 - 71	915.9 - 927.1	1.6	500

**Note:**

For -868M model, default frequency is EU868;

For -915M model, default frequency is AU915.

## 4.4 Solenoid Settings

Go to “**General->Device Settings->Basic**” of ToolBox software or “**Setting->General Settings**” of ToolBox App to change the reporting configurations.

Device Type	<input type="text" value="UC512"/>
Reporting Interval	<input type="text" value="20"/> min
Solenoid Valve Wiring Switch	<input checked="" type="checkbox"/>
Data Reporting	<input type="text" value="All"/>
Device Return to Power Supply State	<input type="text" value="Return to previous working state"/>
Class Type	<input type="text" value="Class A"/>
Response Time	<input type="text" value="600"/> s
Change Password	<input type="checkbox"/>

Parameters	Description
Reporting Interval	Reporting interval of transmitting data to network server.Default: 20min
Solenoid Valve Wiring Switch	After this parameter is enabled, when users connect the solenoid cable to any solenoid interface, the device will turn on automatically.
Data Reporting	Select the contents to report to network server. All: Report all interface status; Valve 1& Water Meter 1: Report the status of the Valve 1 interface and data of GPIO1; Valve 2& Water Meter 2: Report the status of the Valve 2 interface and data of GPIO2.
Device returns to the power supply state	If the device loses power and return to power supply, the device will be on or off according to this parameter.
Class Type	Working mode of LoRaWAN® device. UC511: Class A and Class C are available; UC512: Class A.
Response Time	When the device works under Class A mode, it only receives control commands every reporting interval comes. In order to shorten the delay time of control, the device will send blank package to allow to receive the

	control commands every Response Time interval. <b>Note:</b> The shorter the response time, the shorter the battery life.
Change Password	Change the password for ToolBox App or software to read/write this device.

**Note:**

- 1) When device connects to network server of Milesight gateway, the blank package will take up the frame count but not show on the package list.
- 2) The device only starts counting after receiving more than 5 pulses.
- 3) Reboot or re-join will not affect the counting.

## 4.5 Maintenance

### 4.5.1 Upgrade

UC51x series support upgrade locally or over the air only via ToolBox software.

#### Maintenance >

#### Upgrade Locally:

Step 1: Click “Browse” to import firmware from your computer.

Step 2: Click “Upgrade” to start the upgrade.

#### Upgrade Over the Air:

Step 1: Select the upgraded server according to your region and make sure your computer can access the Internet.

Step 2: Click “Up to date” to search for latest firmware of devices. If your firmware is latest version, ToolBox will prompt “Your device is up to date”.

**Note:** Any operation on ToolBox is not allowed during upgrading, otherwise the upgrading will be interrupted, or even the device will break down.

## 4.5.2 Backup

UC51x devices support configuration backup for easy and quick device configuration in bulk.

Backup is allowed only for devices with the same model and LoRa frequency band. Please select one of following methods to backup device:

### Via ToolBox Software

Step 1: Go to “Maintenance->Backup and Reset”, click “Export” to save current configuration as json format backup file.

Step 2: Click “Browse” to select backup file, then click “Import” to import the configurations.

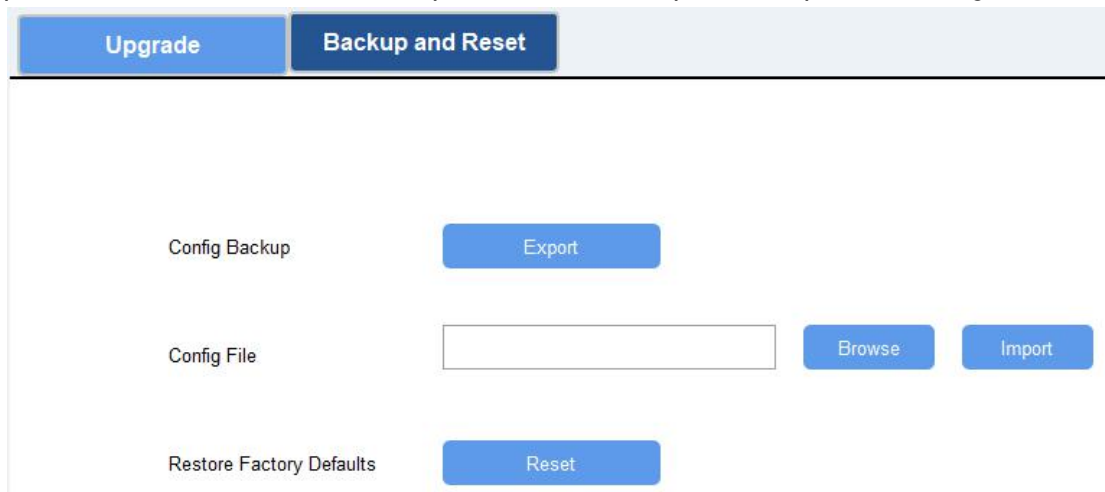

The screenshot shows the 'Backup and Reset' section of the ToolBox Software interface. It features three main rows of controls:

- Config Backup:** A blue button labeled 'Export'.
- Config File:** A text input field, a blue 'Browse' button, and a blue 'Import' button.
- Restore Factory Defaults:** A blue button labeled 'Reset'.

### Via ToolBox APP

Step 1: Go to “Template” page on the APP and save current settings as a template. You can also edit the template file.

Step 2: Select this template and attach to another device to write configuration.

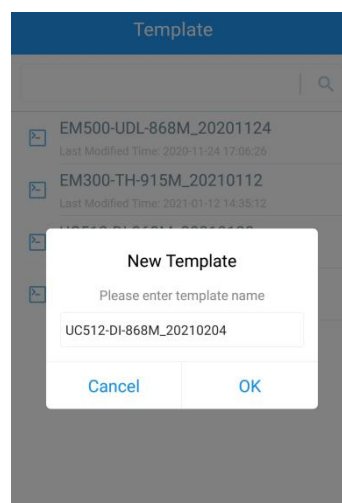

The screenshot shows the 'Template' page in the ToolBox APP. It displays a list of templates with their names and last modified times. A 'New Template' dialog box is open in the foreground, prompting the user to enter a template name. The name 'UC512-DI-868M\_20210204' is entered in the input field. The dialog has 'Cancel' and 'OK' buttons.



### 4.5.3 Reset to Factory Default

Please select one of following methods to reset device:

**Via Hardware:** Open the case of UC51x and hold on power button more than 10s.

**Via ToolBox Software:** Go to "Maintenance->Backup and Reset" to click "Reset".

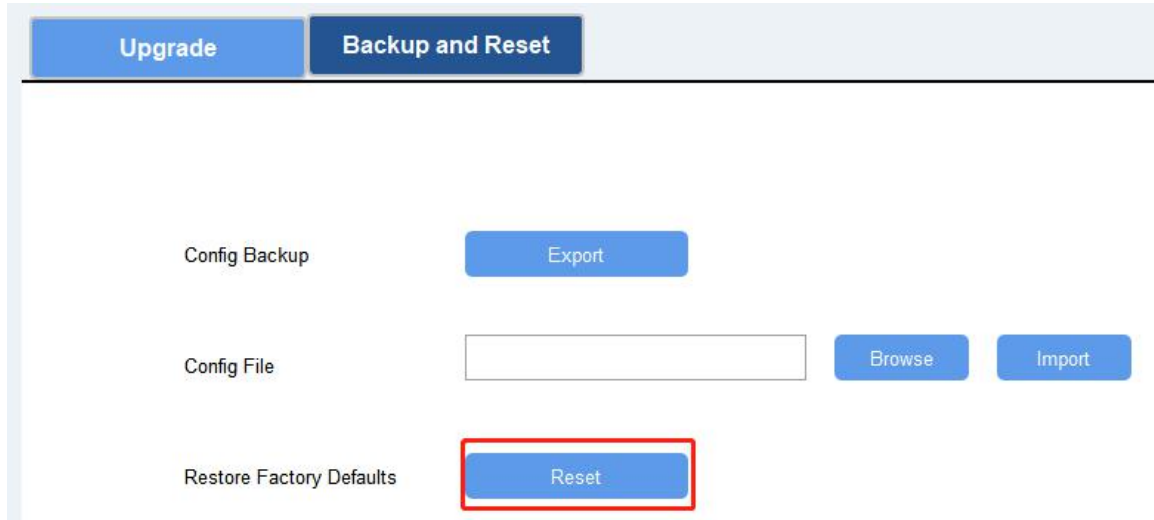

**Via ToolBox APP:** Go to "Device->Reset" to click "Reset", then attach smart phone with NFC area to UC51x to complete reset.

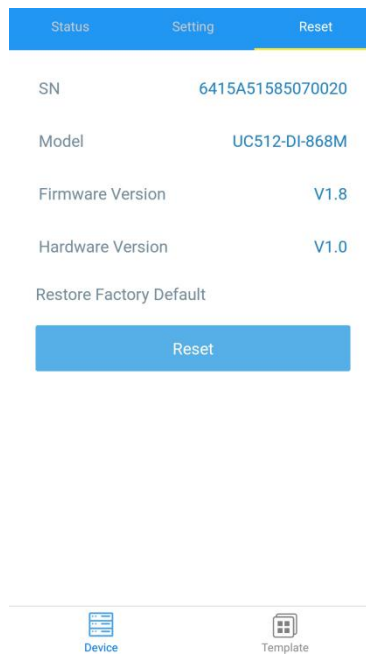

## 5. Milesight IoT Cloud Management

UC51x series can be managed by Milesight IoT Cloud platform. Milesight IoT cloud is a comprehensive platform that provides multiple services including device remote management and data visualization with the easiest operation procedures. Please register a Milesight IoT Cloud account before operating following steps.

### 5.1 Add a Milesight Gateway

Step 1: Enable “Milesight” type network server and “Milesight IoT Cloud” mode in gateway web GUI.

**Note:** Ensure gateway has accessed the Internet.

The screenshot shows the 'General Setting' page for a gateway. The left sidebar contains menu items: Status, Packet Forwarder, Network Server, Network, System, Maintenance, and APP. The main content area has tabs for General, Radios, Advanced, Custom, and Traffic. Under 'General Setting', the following fields are visible: Gateway EUI (24E124FF...), Gateway ID (24E124FF...), and Frequency-Sync (Disabled). Below this is a 'Multi-Destination' table with the following data:

ID	Enable	Type	Server Address	Operation
0	Enabled	Milesight	localhost	[Edit] [Delete]

The screenshot shows the 'General Setting' page for a gateway. The left sidebar contains menu items: Status, Packet Forwarder, Network Server, Network, System, and Maintenance. The main content area has tabs for General, Applications, Profiles, Device, and Gateways. Under 'General Setting', the following fields are visible: Enable (checked), Milesight IoT Cloud (checked), NetID (010203), Join Delay (5 sec), RX1 Delay (1 sec), Lease Time (8760-0-0 hh-mm-ss), and Log Level (info).

Step 2: Go to “My Devices” page and click “+New Devices” to add gateway to Milesight IoT Cloud via SN. Gateway will be added under “Gateways” menu.

**Add Device** ✕

\* SN:

\* Name:

i Please enable Milesight IoT Cloud mode on gateway first.

Cancel Confirm

Step 3: Check if gateway is online in Milesight IoT Cloud.

Status	Name	Associated Devices (Joined / Not Joined / Failed)	Last Updated
<span style="color: green;">●</span> Normal	UG Gateway 621793129987	0 / 0 / 0 <a href="#">Detail</a>	a few seconds ago
<span style="color: orange;">●</span> Offline	UG Gateway 6222A3243835	0 / 1 / 0 <a href="#">Detail</a>	2021-02-03 09:41

## 5.2 Add UC51x to Milesight IoT Cloud

Step 1: Go to “My Devices” page and click “+New Devices”. Fill in the SN of UC51x and select associated gateway.

**Add Device** ✕

\* SN:

\* Name:

\* Associated Gateway:

\* Device EUI:

\* Application Key:

Cancel Confirm

Step 2: Default working mode of UC511 devices is Class C. If you need to change the mode of UC511 to Class A, click and go to “Basic Settings” to change mode to Class A.

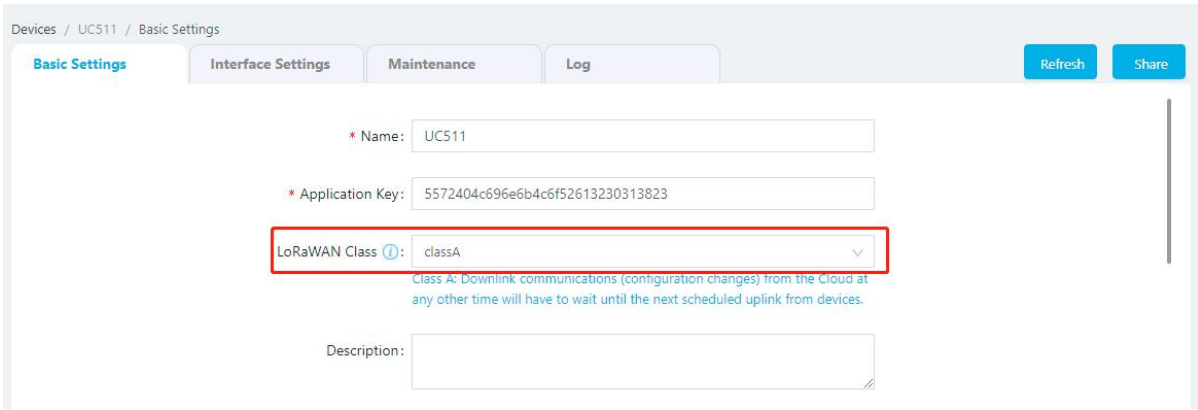

Step 3: Click  and go to "Interface Settings" to select used interfaces and customize the name and thresholds.

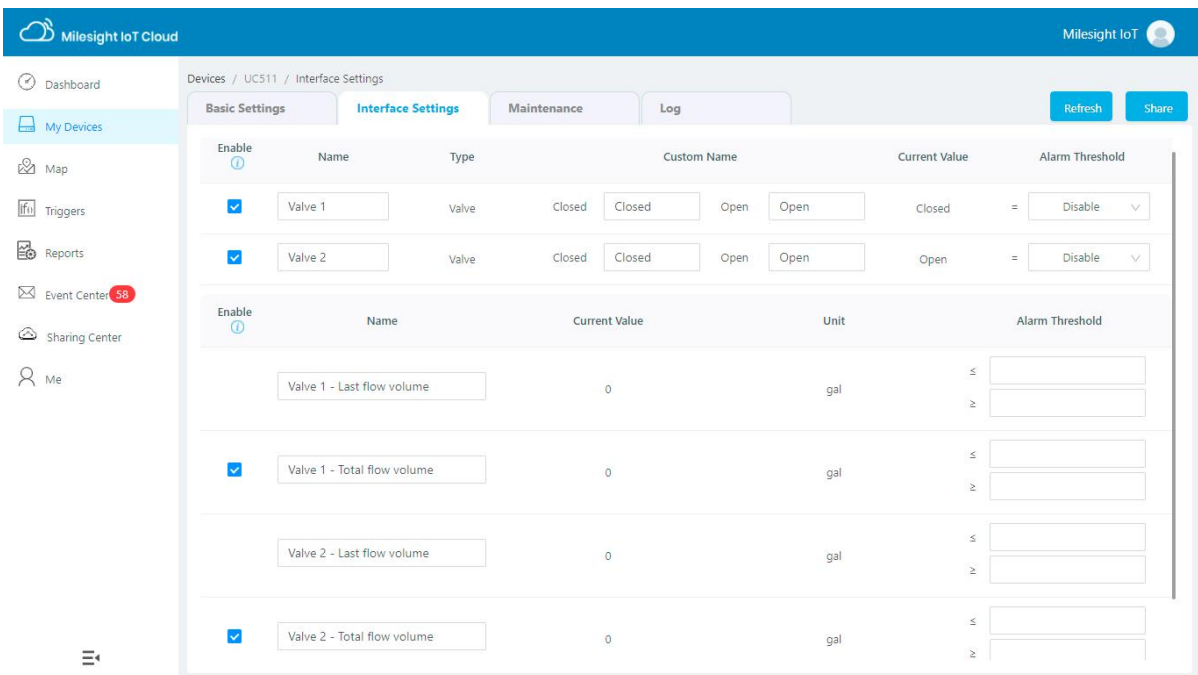

Besides, go to "Basic Settings" to configure the unit of per pulse if you connect the water meter.

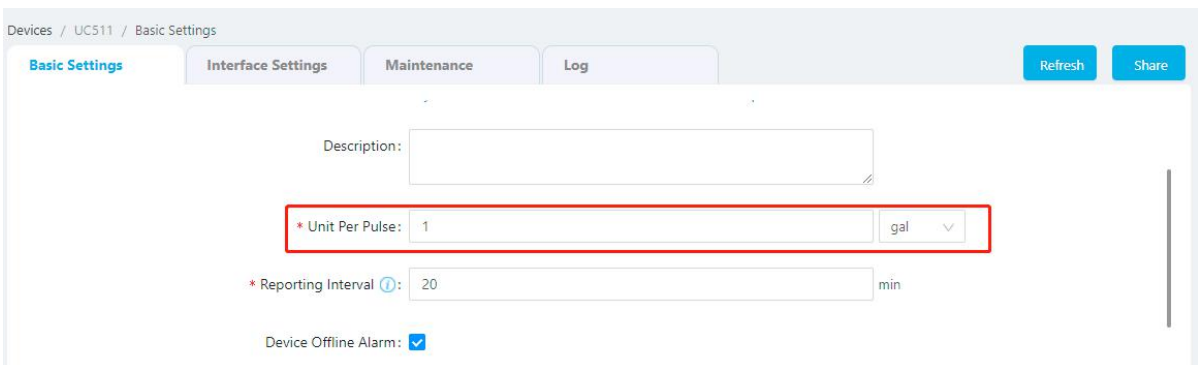

### 5.3 Solenoid Valve Control

Solenoid valve can be controlled by Milesight IoT cloud webpage or App.

Step 1: Click  to open the solenoid valve and configure the duration.

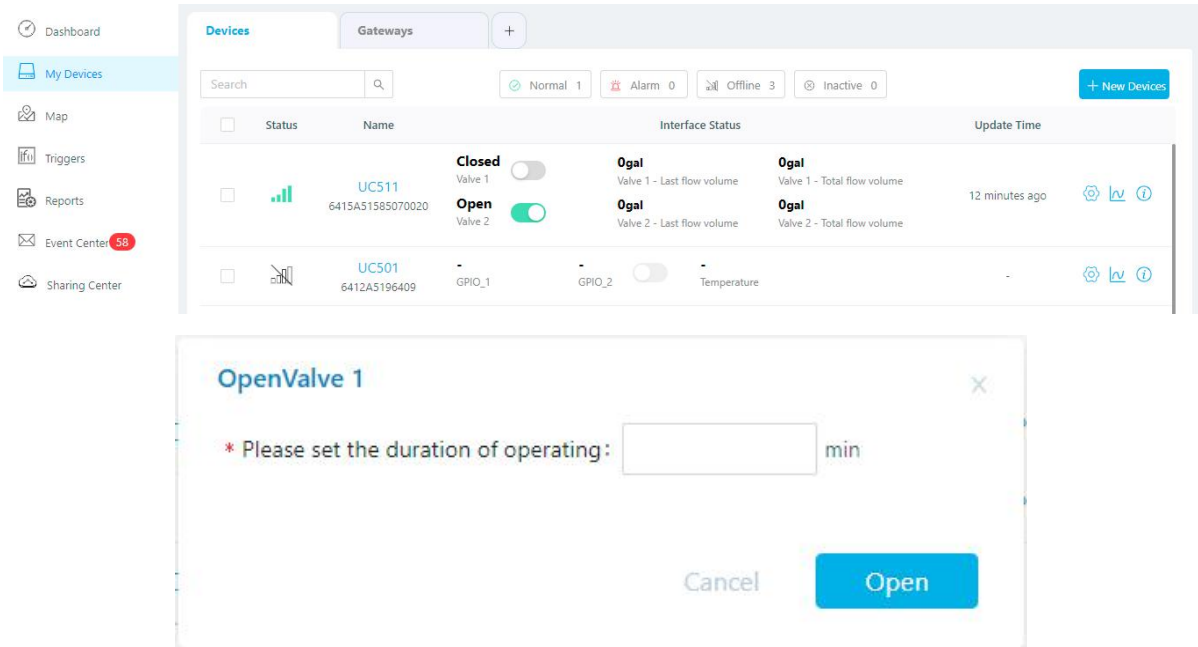

You can also add a switch on the dashboard to control the status of solenoid valves.

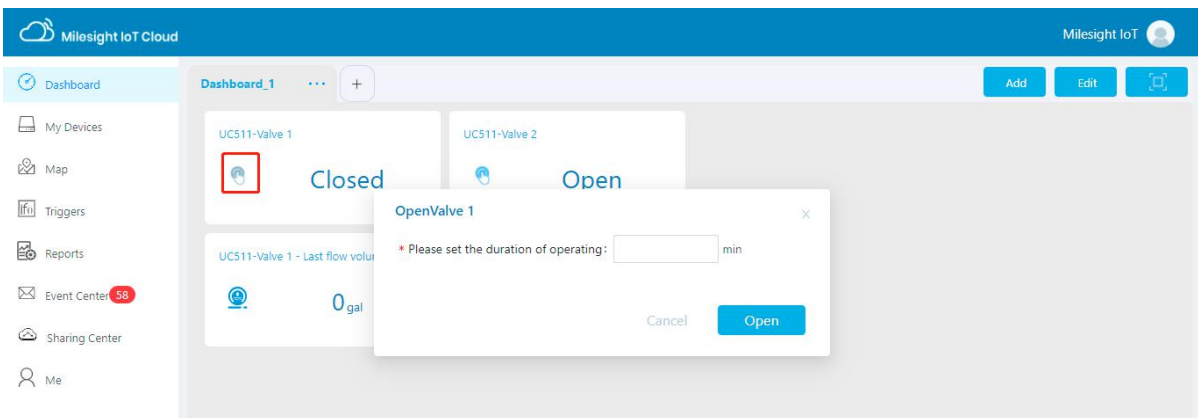

**Note:** If working mode of UC51x is Class A, control commands will delay until the time icon disappear.

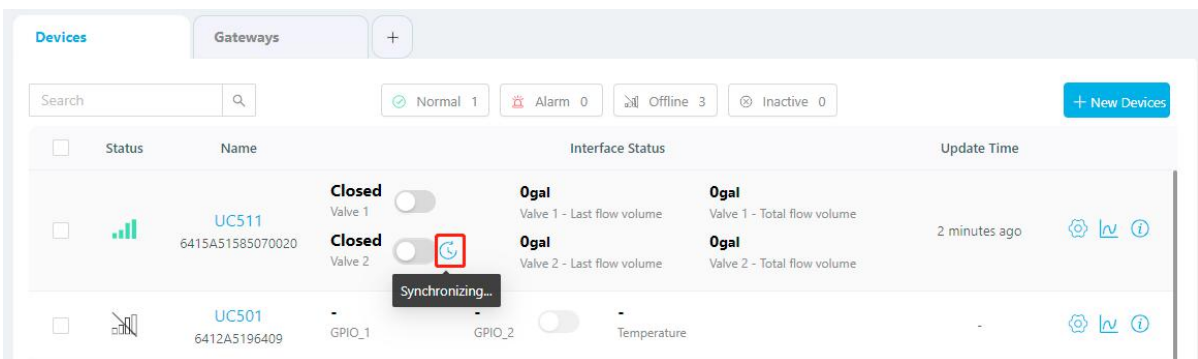

Step 2: Go to “Triggers” page to add actions to trigger the solenoid valve to open for a period of time or a specific volume of water.

**Note:** Water volume control is only worked when you connect water meter to UC51x device.

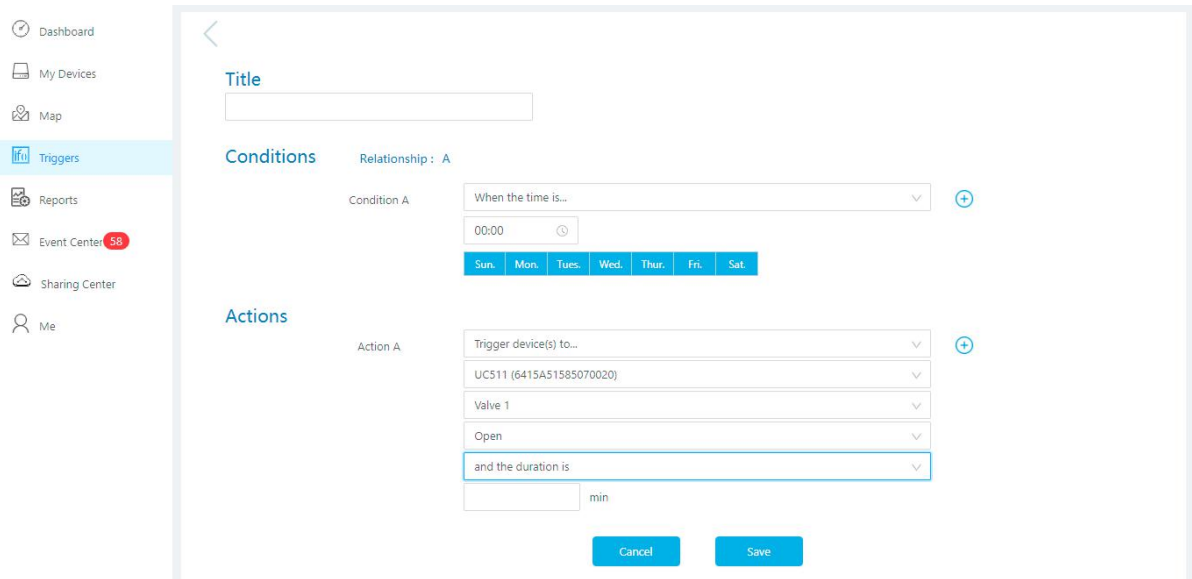

## 6. Device Payload

UC51x Series use the standard Milesight IoT payload format based on IPSO. Please refer to the

***UC51x Series Communication Protocol***, for decoders of Milesight IoT products please click

[here](#).

**-END-**