

MPPT Control display manual

Table of Contents

1. Introduction	1
2. Mounting	3
3. Installation	5
4. Operation	7
4.1. Status menu	8
4.2. History menu	8
4.3. Settings menu	10
5. Troubleshooting and Support	12
5.1. Power issues	12
5.2. Connection issues	12
5.3. Settings locked	12
6. Warranty	13
7. Specifications	14

1. Introduction

The MPPT Control display is a dedicated display for the Victron Energy SmartSolar and BlueSolar MPPT solar charger range. It can be used to read out the live and historic solar charger data and it can be used to configure solar charger settings.

Examples of live and historic monitoring:

- PV power, yield, voltage and current.
- Battery voltage, current and charge stage.
- Load output state and current (only available if the solar charger is equipped with a load output).
- 30-day historical values
- Cumulative historic values over the live of the solar charger

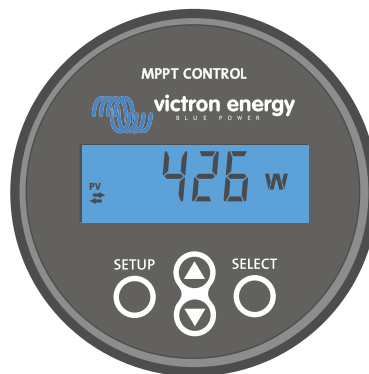

The MPPT Control display



The MPPT Control display can be used with the whole range of BlueSolar and SmartSolar MPPT solar chargers. However, for solar chargers rated 60A consider using the better suited [SmartSolar Control display](#) instead.

Power cable

The display ships together with a fused power cable.

The supplied power cable is only needed when the display is used with some very early solar charger models that have been since long discontinued. These early models shut down when they do not receive solar power. The power cable provides power to the display straight from the battery so that the display is also operational during bad weather or after the sun has gone down.

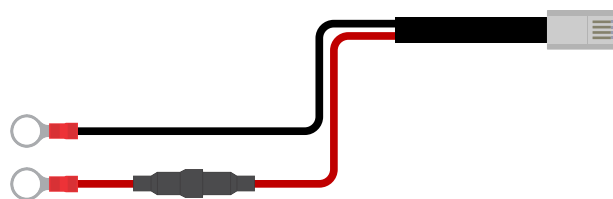

Power cable

VE.Direct cable

A VE.Direct cable is needed to connect the display to the solar charger. This cable is not included with the MPPT Control display and needs to be purchased separately.

VE.Direct cables vary in lengths from 0.3 up to 10 meter and are available with straight or right angle connectors. For more information see the [VE.Direct cable product page](#).



VE.Direct cable

Wall mounting enclosure

The housing of the MPPT Control display is tailored towards being flush mounted through a panel. In case flush mounting is not possible a dedicated wall mount enclosure can be used. This enclosure allows for easy wall mounting of the display.

There are two wall mounting options:

- [Wall mount enclosure for BMV or MPPT Control](#)
- [Wall mount enclosure for BMV and Color Control GX](#)

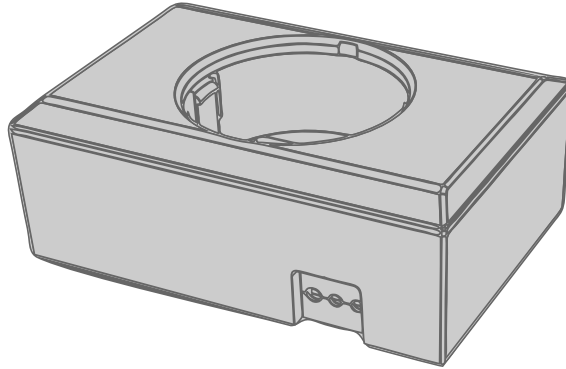

Wall mount enclosure for BMV or MPPT Control

2. Mounting

Drill a hole in a mounting substrate as indicated in below figure.

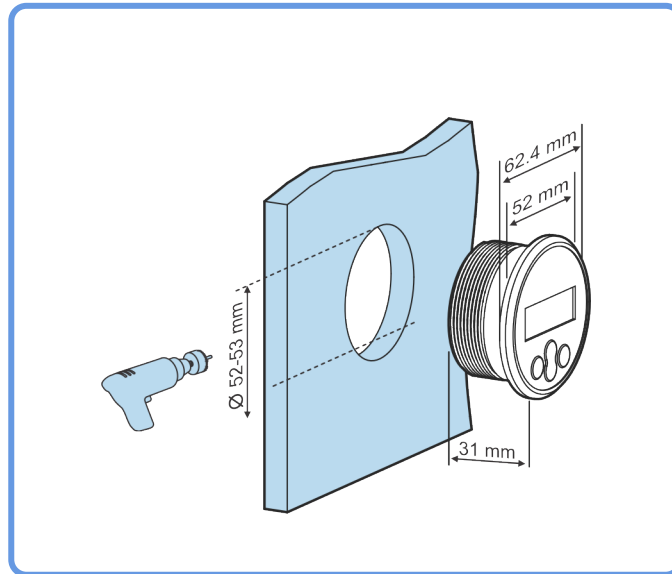

Mounting recess width and depth requirements

Mount the display:

Use option A if the mounting substrate is accessible from both sides

Use option B if the mounting substrate is accessible from the front.

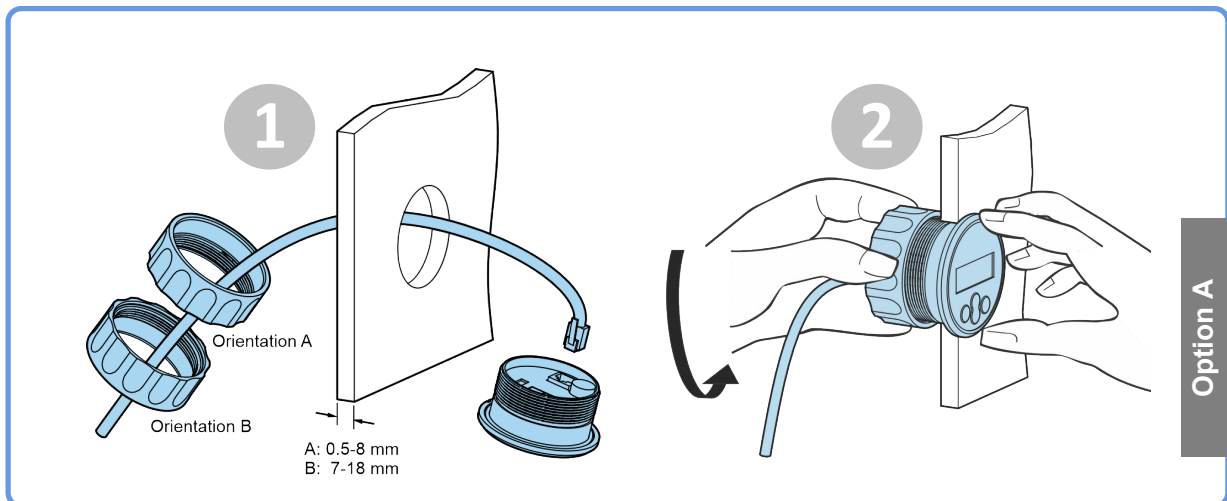

Mounting option A

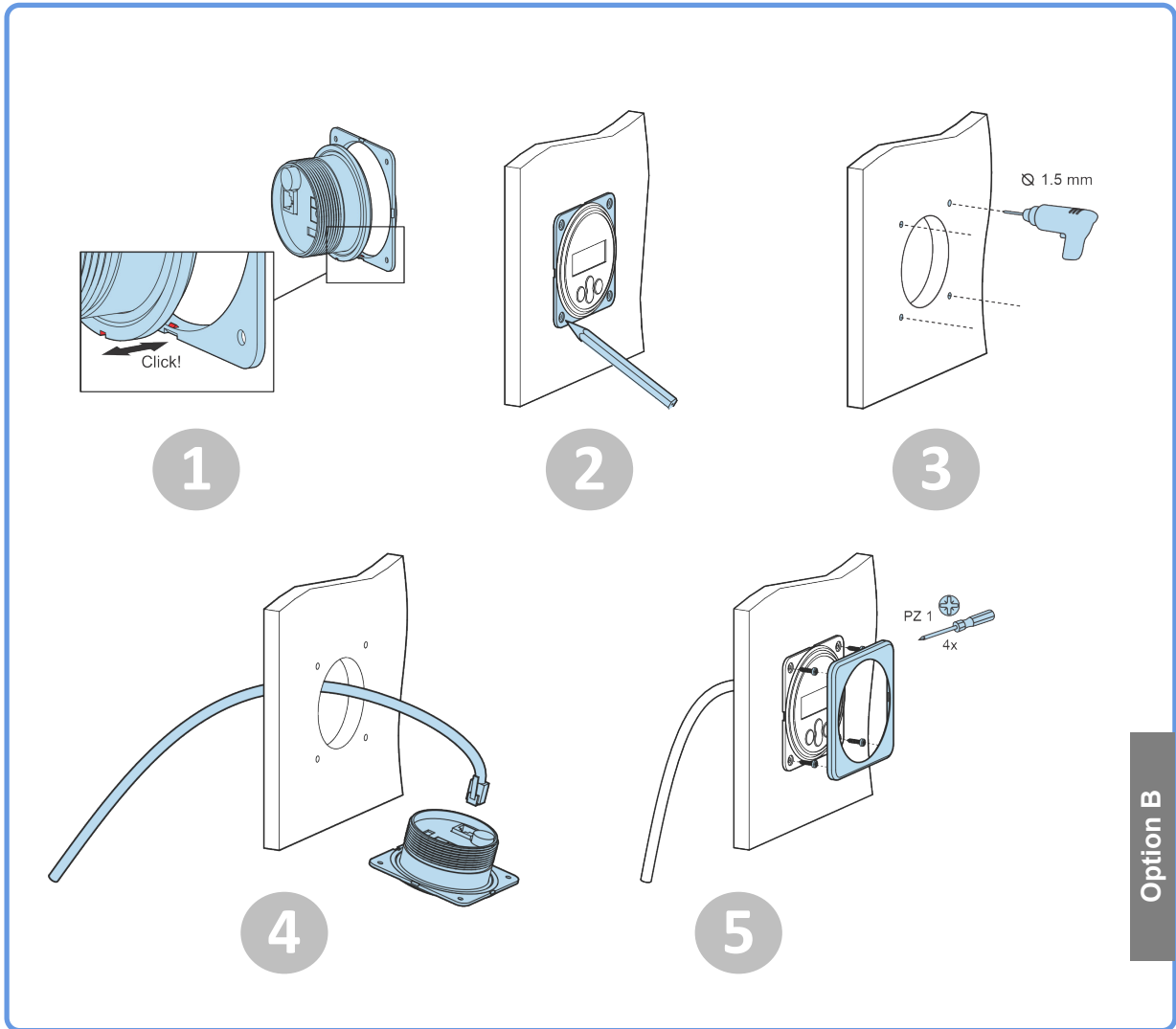

Mounting option B

3. Installation

Connect the solar charger

Connect the MPPT Control display to the solar charger using a VE.Direct cable.

It is not possible to extend the VE.Direct cable, the maximum length can not exceed 10 meter.

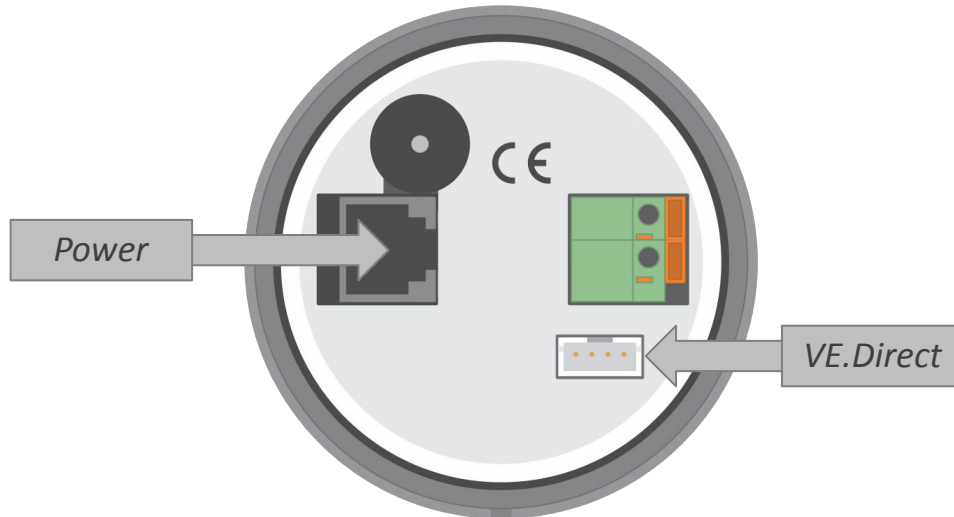

The rear of the MPPT Control display showing the power connection and the VE.Direct connection

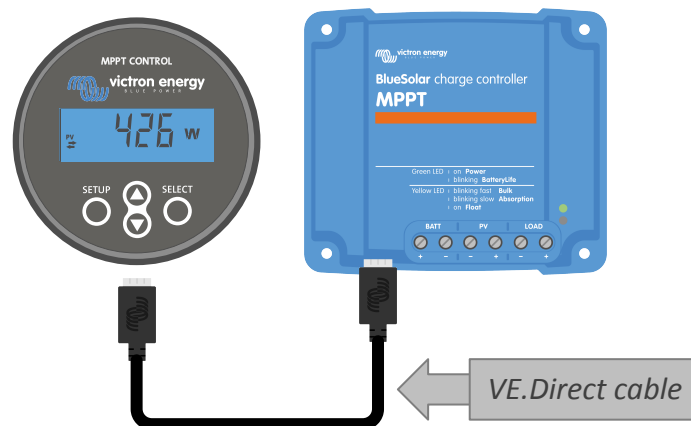

Connect the display to the solar charger via a VE.Direct cable

Connect the power cable (only needed for old style solar controllers)



The supplied power cable is only necessary when the display is used with some very early solar charger models that have been since long discontinued.

Connect the power cable as follows:

- Connect the black wire ring cable lug to the negative battery terminal. If a battery monitor is used in the system, connect the black wire to the system side of the battery monitor shunt instead.
- Connect the red cable ring cable lug to the positive battery terminal.
- Plug the the RJ12 terminal into the power terminal on the back of the display.

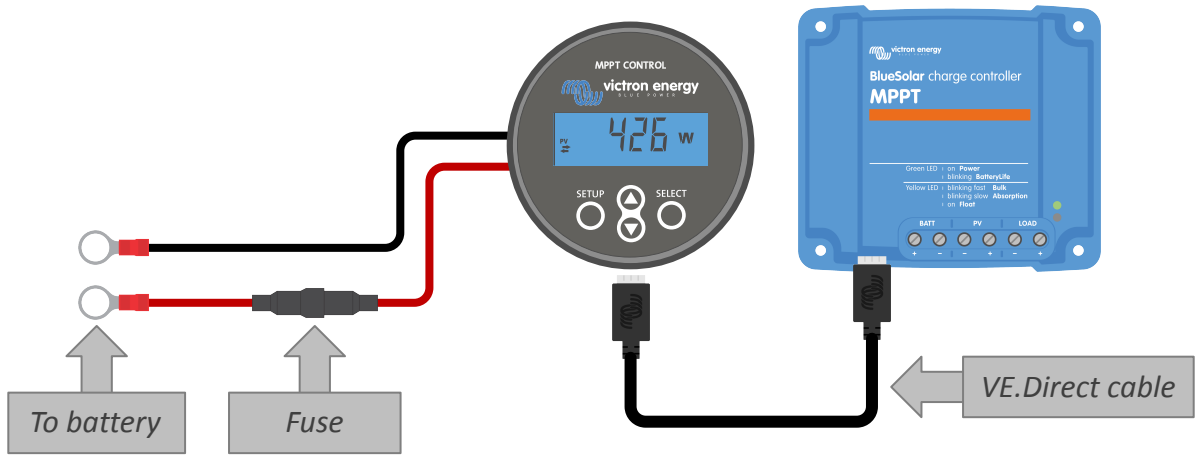

Connect the display to an old model solar charger and the battery

4. Operation

The LCD screen displays the following information:

- A number reading.
- The unit of the reading: V, A, W, kWh, h or !
- The type of reading: load, battery, PV, min, max or charge stage.
- Connection status indicator.



Full LCD readout

A	B	C	D	E	F	G	H	I	J	K	L	M	N	O	P	Q	R
A	b	C	d	E	F	G	H	I	J	K	L	M	N	O	P	Q	R
S	T	U	V	W	X	Y	Z	0	1	2	3	4	5	6	7	8	9
S	T	U	V	W	X	Y	Z	0	1	2	3	4	5	6	7	8	9

The digits used to represent letters and numbers

The connection status of the display is indicated by a "double arrow" ⇔ symbol as indicated in below table.

Indicator	connection status
⇔ On	There is a connection between the display and the solar charger
⇔ Blinking	There was a connection with the solar charger but the connection is lost. The last know values will be shown.
⇔ Off	There has not been a connection with a solar charger.

The buttons on the front of the display are used to navigate through the solar charger readings and are used when making solar controller and display settings. They have the following functions:







Button	Action
	Cancel or Back
	Select or Confirm
	Go to next or previous item or Increase or decrease value

4.1. Status menu

This menu shows the live solar charger readings. The MPPT Control display always starts up in this menu.

Press the up and down button cycle through all menu items.

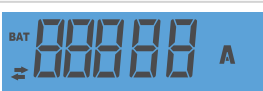
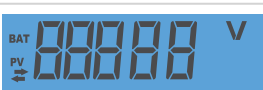
These menu items will be displayed in order of appearance as indicated in below table:

LCD Display	Menu item	Description and notes
	PV power	Solar array output power.
	PV voltage	Solar array voltage.
	PV daily yield	The daily accumulative solar power received.
	Battery error	Only visible in case there is an active error.
	Battery charge stage	Charge stage: Bulk, Absorption, Float, Off or Fault.
	Battery current	Battery charge current.
	Battery voltage	Battery voltage.
	Load output state	Load output switched on or off. Only visible on MPPTs with a load output.
	Load current	The current into the load. Only visible on MPPTs with a load output.

4.2. History menu

The history menu shows both the daily and overall solar charger history data. It shows items such as solar yield, battery voltages, time spend in each charge stage and past errors.

To enter and readout the history menu:



- Press the SELECT button, while in the status menu.
- Press the up or down button to navigate through the history items.
- When arriving at the desired history item, press the SELECT button to see the value of that item.
- If an item contains multiple values, press the SELECT button and then the up or down button to browse the various values within that item. For the daily items it is possible to scroll back to 30 days ago (data becomes available over time), a brief popup shows the day number.
- To go back to the main history menu press the SETUP button.
- To go back to the status menu press the SETUP button again.



History menu navigation chart

All available history menu items are listed in below table, in the order they appear when scrolling through the items.

LCD	Scrolling text	Description
	TOTAL YIELD	The cumulative PV yield since the last history reset.
	MAX PANEL VOLTAGE	The maximum PV voltage since the last history reset.
	MAX BATTERY VOLTAGE	The maximum battery voltage since the last history reset.
	MIN BATTERY VOLTAGE	The minimum battery voltage since the last history reset.
	LAST ERRORS	The last 4 errors since the last history reset. The number of blocks in the lower right of the LCD determines which error is currently shown, with 1 block being the latest and 4 blocks being the oldest.
	YIELD	The daily PV yield, available for each day for the past 30 days.
	MAX POWER	The daily maximum PV power, available for each day for the past 30 days.
	MAX PANEL VOLTAGE	The daily maximum PV voltage, available for each day for the past 30 days.
	MAX BATTERY CURRENT	The daily maximum battery current, available for each day for the past 30 days.
	MAX BATTERY VOLTAGE	The daily maximum battery voltage, available for each day for the past 30 days.
	MIN BATTERY VOLTAGE	The daily minimum battery voltage, available for each day for the past 30 days.
	BULK TIME	The daily time spent in the bulk charge stage, available for each day for the past 30 days.
	ABSORPTION TIME	The daily time spent in the bulk absorption stage, available for each day for the past 30 days.

LCD	Scrolling text	Description
	FLOAT TIME	The daily time spent in the float stage, available for each day for the past 30 days.
	LAST ERRORS	The last 4 daily errors. The number of blocks in the lower right of the LCD determines which error is currently shown, with 1 block being the latest and 4 blocks being the oldest.

4.3. Settings menu

In the settings menu the the solar charger and MPPT Control settings can be viewed and changed.

 Do not change settings unless you know what they are and what the effect of changing these setting can be. Incorrect settings may cause system problems including damage to batteries. When in doubt, seek advice from an experienced Victron Energy installer, dealer or distributor.

To navigate the settings menu:

- Press the SETUP button for 2 seconds to enter the settings menu
- The first menu item is shown.
- Navigate to the desired menu item by pressing the up and down button.
- Once arrived at the desired menu item, press the SELECT button to view the value the setting has been set to.
- To modify this setting press the SELECT button again. teh value will now blink.
- Press the up or down button to choose the desired value.
- Press SELECT to confirm the change, you will hear a beep and will see the word SAVED. The change is made final.
- Navigate to the next menu item, or press SETUP to return to the setup menu.
- To leave the setting menu, press the SETUP button again.

It might be possible that the setup menu is locked, in which case the settings can only be viewed. When trying to change the setting the word LOCK is shown.

To unlock the settings menu:

- Navigate to settings menu item 01 LOCK SETUP
- Press the SETUP button, the setting ON is displayed
- Press the SETUP button again
- Press the down arrow button and select OFF
- To leave the setting press the SETUP button.

When SELECT TO EDIT is ON, the current value is shown and a new value can immediately be selected.

When LOCK SETUP is ON, settings can only be changed after setting LOCK SETUP to off

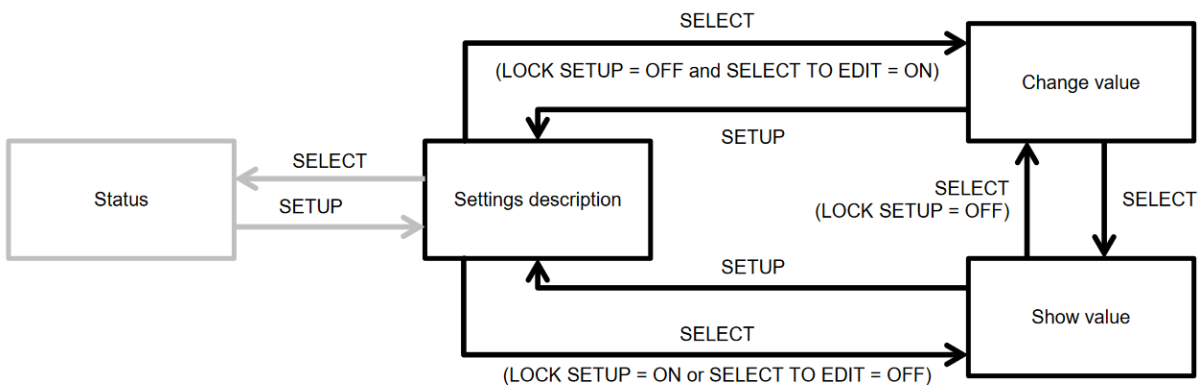

MPPT Control setting navigation chart

All available settings are indicated in below table, in the order they appear when scrolling trough the menu, together with a basic description of each setting. For the full description of the solar charger settings refer to the solar charger manual.

Not all setting listed in below table might be available when connecting to certain models of solar chargers. The solar charger might not have the necessary hardware. For example, not all solar chargers are equipped with a load output.

Some settings might be missing from the settings menu. The MPPT Control display only allows to change the most common settings. More advance settings, like TX and RX port settings, are not accessible via the MPPT Control display. To configure these settings use the [VictronConnect App](#) or, for solar chargers 60A and up, use a [SmartSolar Control display](#).

Number	Name	Setting
01	LOCK SETUP	When set to ON, none of the other settings can be changed. If an attempt is made to change a setting the word "LOCK" is shown together with the setting value. Set to OFF to unlock, so other settings can be changed.
02	BATTERY VOLTAGE	The system battery voltage; choose between a voltage setting or AUTO. When set to automatic (AUTO), an A will be shown in front of the voltage setting.
03	BATTERY TYPE	The charge algorithm for a specific battery type; set to FIXED or USER. When set to FIXED, the rotary switch on the solar charger determines the battery type. When set to USER, all charging related settings can be edited. As soon as any of the charging related settings are changed, this setting will automatically set to USER.
04	MAXIMUM CURRENT	The maximum charging current.
05	BULK TIME LIMIT	The maximum time the bulk charge stage is allowed to last.
06	ABSORPTION TIME LIMIT	The maximum time the absorption charge stage is allowed to last.
07	ABSORPTION VOLTAGE	The battery voltage at which the solar charger switches from bulk to absorption stage.
08	FLOAT VOLTAGE	The battery voltage at which the solar charger switches from absorption to float stage.
09	TEMP COMPENSATION	The temperature compensation coefficient in mV/°C for the whole battery bank (not per individual battery).
10	LOAD OUTPUT	The Load output operating mode. Possible values: OFF, AUTO (= BatteryLife), ALT1, ALT2, ON, USER1, USER2
11	LOAD SWITCH HIGH	The high voltage level in case LOAD OUTPUT is set to USER1 or USER2
12	LOAD SWITCH LOW	The low voltage level in case LOAD OUTPUT is set to USER1 or USER2
13	CLEAR HISTORY	Clears the solar charger history
14	FACTORY DEFAULTS	Resets the solar charger settings back to factory defaults.
15	BACKLIGHT INTENSITY	Sets the back-light intensity of the MPPT Control LCD display.
16	BACKLIGHT ALWAYS ON	Determines whether the back-light of the MPPT Control LCD display is always on.
17	SCROLL SPEED	Determines the scroll speed of the MPPT Control.
18	SELECT TO EDIT	When set to OFF, the MPPT Control first shows the value of a setting and SELECT has to be pressed to be able to edit the value.
19	AUTO LOCK	When set to ON, the LOCK SETUP setting will be automatically set to ON 2 minutes after a setting has been changed.
20	SOFTWARE VERSION	The software (firmware) version of the MPPT Control.
21	SERIAL NUMBER	The serial number of the MPPT Control.
22	MPPT SOFTWARE VERSION	The software (firmware) version of the solar charger.
23	MPPT SOFTWARE VERSION	The serial number of the solar charger.
24	EQUALISATION VOLTAGE	Equalization voltage.
25	EQUALIZE	Initiates a manual equalization.

5. Troubleshooting and Support

Consult this chapter in case of unexpected behaviour or if you suspect a product fault.

The correct troubleshooting and support process is to first consult the common issues as described in this chapter.

Should this fail to resolve the issue, contact the point of purchase for technical support. If the point of purchase is unknown, refer to the [Victron Energy Support webpage](#).

5.1. Power issues

The display is powered via the VE.Direct cable or via the power cable. If the display does not power up check these cables.

VE.Direct cable check:

1. Check if the VE.Direct is plugged into the back of the display
2. Check if the VE.Direct cable is plugged into the solar charger
3. Make sure the VE.Direct connectors are inserted all the way into the VE.Direct ports.
4. Check the VE.Direct port pins; ensure that they are not damaged, bent or missing.
5. Check if the solar charger is able to provide power via the VE.Direct cable when no PV input (at night). Some very early solar chargers models, that have been since long discontinued need to have the power cable installed.

Power cable check

1. Check the fuse in the power cable.
2. Check if the power cable is plugged into the back of the display.
3. Check if the power cable is connected to the battery or to another supply voltage.
4. Check if the supply voltage is between 6.5 and 95 Vdc.

5.2. Connection issues

If the display is unable to make a connecting with the solar charger or if the text: "Disconnected " is scrolling through the screen, the MPPT Control has not established communications with the solar charger.

The most likely cause is an issue with the VE.Direct cable.

VE.Direct cable check

1. Check if the VE.Direct is plugged into the back of the display.
2. Check if the VE.Direct cable is plugged into the solar charger.
3. Make sure the VE.Direct connectors are inserted all the way into the VE.Direct ports.
4. Check the VE.Direct port pins; ensure that they are not damaged, bent or missing.

5.3. Settings locked

If the setup menu is locked settings can only be viewed but not changed. When trying to change the setting the word LOCK is shown.

To unlock the settings menu see the instruction in the [Settings menu \[10\]](#) chapter.

6. Warranty

This product has a 5-year limited warranty. This limited warranty covers defects in materials and workmanship in this product and lasts for five years from the date of original purchase of this product. To claim warranty the customer must return the product together with the receipt of purchase to the point of purchase. This limited warranty does not cover damage, deterioration or malfunction resulting from alteration, modification, improper or unreasonable use or misuse, neglect, exposure to excess moisture, fire, improper packing, lightning, power surges, or other acts of nature. This limited warranty does not cover damage, deterioration or malfunction resulting from repairs attempted by anyone unauthorized by Victron Energy to make such repairs. Non-compliance with the instructions in this manual will render the warranty void. Victron Energy is not liable for any consequential damages arising from the use of this product. The maximum liability of Victron Energy under this limited warranty shall not exceed the actual purchase price of the product.

7. Specifications

Electrical	
Supply voltage range when powered from battery	6.5 - 95Vdc
Supply voltage range when powered via VE.Direct cable	5Vdc
Power consumption with back-light turned off	< 0.05W
Operating temperature range	-20 - +50°C (0 - 120°C)
Power cable fuse rating	100mA

Mechanical	
Installation type	Flush mount
Front diameter	63mm (2.5")
Front bezel	69 x 69mm (2.7x2.7")
Body diameter	52mm (2.0")
Body depth	31mm (1.2")
Power cable length	1.5m
Weight	50g

Suitability	
Suitable for the entire Victron Energy BlueSolar MPPT and the SmartSolar MPPT solar charger range, with the exception of the (since long) discontinued BlueSolar MPPT 70/15.	