



Ruijie RG-EG Series Routers

Hardware Installation and Reference Guide

Copyright Statement

Ruijie Networks©2020

Ruijie Networks reserves all copyrights of this document. Any reproduction, excerption, backup, modification, transmission, translation or commercial use of this document or any portion of this document, in any form or by any means, without the prior written consent of Ruijie Networks is prohibited.

Exemption Statement

This document is provided "as is". The contents of this document are subject to change without any notice. Please obtain the latest information through the Ruijie Networks website. Ruijie Networks endeavors to ensure content accuracy and will not shoulder any responsibility for losses and damages caused due to content omissions, inaccuracies or errors.



Preface

Thank you for using our products. This manual will guide you through the installation of the device.

This manual describes the functional and physical features and provides the device installation steps, hardware troubleshooting, module technical specifications, and specifications and usage guidelines for cables and connectors.

Audience

It is intended for the users who have some experience in installing and maintaining network hardware. At the same time, it is assumed that the users are already familiar with the related terms and concepts.

Obtaining Technical Assistance

- Ruijie Networks Website: <https://www.ruijienetworks.com/>
- Technical Support Website: <https://ruijienetworks.com/support>
- Case Portal: <https://caseportal.ruijienetworks.com>
- Community: <https://community.ruijienetworks.com>
- Technical Support Email: service_rj@ruijienetworks.com
- Skype: [service_rj@ruijienetworks.com](https://www.skype.com/people/service_rj@ruijienetworks.com)

Related Documents

Documents	Description
Configuration Guide	Describes network protocols and related mechanisms that supported by the product, with configuration examples.
Command Reference	Describes the related configuration commands, including command modes, parameter descriptions, usage guides, and related examples.

Symbol Conventions

 Means reader take note. Notes contain helpful suggestions or references.

 Means reader be careful. In this situation, you might do something that could result in equipment damage or loss of data.



1 Product Overview

Featured with global-leading semiconductor technologies and communication control technologies, Ruijie EG series router is a data communication product developed by Ruijie Networks with independent intellectual property right. The EG series router is designed according to international standards, similar to the mainstream router products in the international market. By reading this manual, a network administrator familiar with mainstream router configuration commands can use this device without training.

1.1 RG-EG105G-P

Specifications

Model	RG-EG105G-P
Storage	DDR2 SDRAM: 128MB
	ROM: 16MB
Power Module	External 60W power adapter
Interface Standard	Ethernet: 10Base-T/100Base-TX/1000Base-TX
Dimension (without rubber pads) (W x H x D)	206.5 mm x 28 mm x 108.5 mm (8.13 in. x 1.1 in. x 4.27 in.)
Voltage	100V to 240V~, 50/60Hz, 1.5A max.
Power Consumption	Less than 60W (With PoE)
PoE	IEEE 802.3af/at, 54W max. output
Working Temperature	0°C to 40°C (32°F to 104°F)
Working Humidity	10% to 90% RH (non-condensing)

-  Please avoid the vibration and collision in the process of moving and usage.
-  Products should be transported in original package.
-  RG-EG105G-P is a Class-A product which may cause radio interference in the living environment. In such a case, the user may need to take feasible measures against such interference.

Appearance

Figure 1-1 Front Panel of RG-EG105G-P

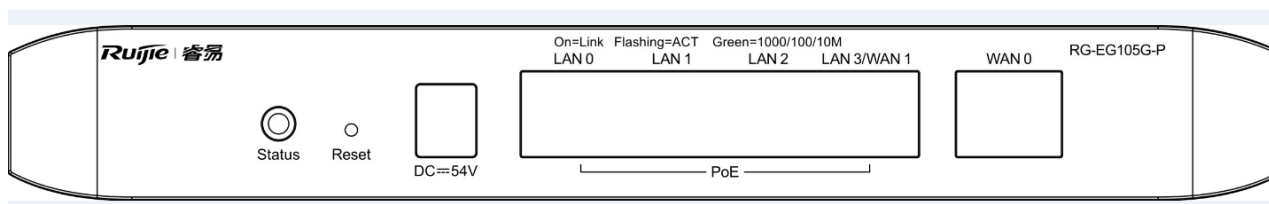
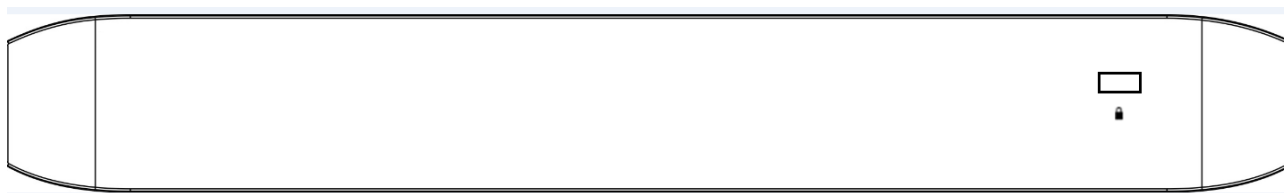

Figure 1-2 Back Panel of RG-EG105G-P



Interface

Interface	Description
WAN	1 WAN port, used to connect to the DSL/Cable modem for Internet access.
LAN	4 LAN ports, used to connect the computer to the switch or access point (AP). The LAN3 port can be used as a WAN port via the Web configuration.

LED Indicator

LED Indicator	Description
Status	Blinking green (0.5Hz): The device has started up, but is not connected to the Ruijie Cloud. Solid green: The device has started up, and is connected to the Ruijie Cloud. Blinking green (10Hz): The device is starting up/shutting down, or PoE overload occurs.
Link/ACT	Solid green: the port is up. Blinking green: data is being transceived on the port.

Button

Button	Description
Reset	Press reset button until the status LED blinks green at 10Hz to restore the device to the factory default setting. The default management IP address is http://192.168.110.1 .

1.2 RG-EG105G

Specifications

Model	RG-EG105G
Storage	DDR2 SDRAM: 128MB
	ROM: 16MB
Power Module	External 12W power adapter
Interface Standard	Ethernet: 10Base-T/100Base-TX/1000Base-TX
Dimension (without rubber pads) (W x H x D)	206.5 mm x 28 mm x 108.5 mm (8.13 in. x 1.1 in. x 4.27 in.)

Voltage	100V to 240V~, 50/60Hz, 1.5A max.
Power Consumption	Less than 6W
Working Temperature	0°C to 40°C (32°F to 104°F)
Working Humidity	10% to 90% RH (non-condensing)

- ⚠ Please avoid the vibration and collision in the process of moving and usage.
- ⚠ Products should be transported in original package.
- ⚠ RG-EG105G is a Class-A product which may cause radio interference in the living environment. In such a case, the user may need to take feasible measures against such interference.

Appearance

Figure 1-3 Front Panel of RG-EG105G

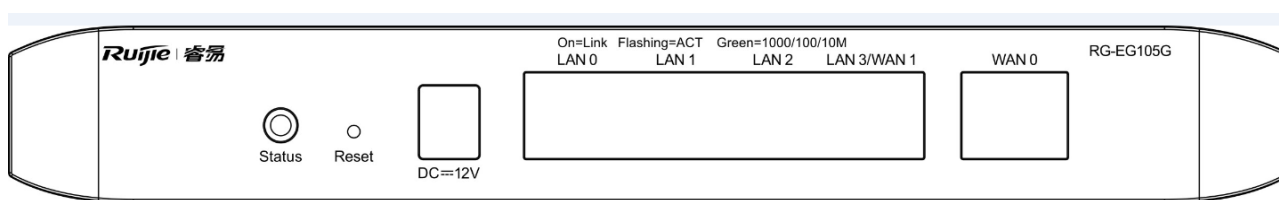
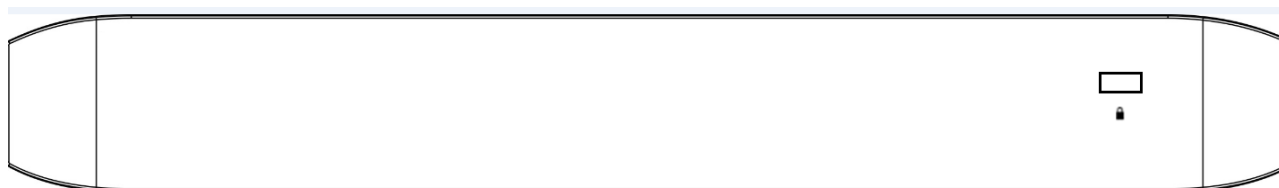

Figure 1-4 Back Panel of RG-EG105G



Interface

Interface	Description
WAN	1 WAN port, used to connect to the DSL/Cable modem for Internet access.
LAN	4 LAN ports, used to connect the computer to the switch. The LAN3 port can be used as a WAN port via the Web configuration.

LED Indicator

LED Indicator	Description
Status	<p>Blinking green (0.5Hz): The device has started up, but is not connected to the Ruijie Cloud.</p> <p>Solid green: The device has started up, and is connected to the Ruijie Cloud.</p> <p>Blinking green (10Hz): The device is starting up/shutting down.</p>
Link/ACT	<p>Solid green: the port is up.</p> <p>Blinking green: data is being transceived on the port.</p>



Button

Button	Description
Reset	Press reset button until the status LED blinks green at 10Hz to restore the device to the factory default setting. The default management IP address is http://192.168.110.1 .

1.3 RG-EG105GW

Specifications

Model	RG-EG105GW
Storage	DDR3 SDRAM: 128MB
	ROM: 16MB
Power Module	Built-in power module
Interface Standard	Ethernet: 5 x 10Base-T/100Base-TX/1000Base-TX ports (4 LAN ports and 1 WAN port by default) 1 USB2.0 port
Transmission Protocol	Concurrent 802.11b/g/n and 802.11a/n/ac.
Operating Bands	802.11b/g/n: 2.4GHz to 2.483GHz 802.11a/n/ac: 5.15GHz to 5.35GHz, 5.47GHz to 5.725GHz, 5.725GHz to 5.85GHz (Country-Specific)
Max Throughput	2.4G: up to 450Mbps 5G: up to 867Mbps Up to 1.317Gbps per device
Transmit Power	27dBm (2.4G) + 25dBm (5G) (Country-Specific)
Dimension (without rubber pads) (W x H x D)	250 mm x 42 mm x 174 mm (9.84 in. x 1.65 in. x 6.85 in.)
Voltage	100V to 240V~, 50/60Hz, 0.6A max.
Power Consumption	Less than 21W
Working Temperature	0°C to 40°C (32°F to 104°F)
Working Humidity	10% to 90% RH (non-condensing)

-  Please avoid the vibration and collision in the process of moving and usage.
-  Products should be transported in original package.
-  Since there are numerous types of U-disk, we cannot ensure that the system supports all of them. The Kingston and SanDisk U-disk with FAT 32 are recommended to be used.

Appearance

Figure 1-5 Front Panel of RG-EG105GW

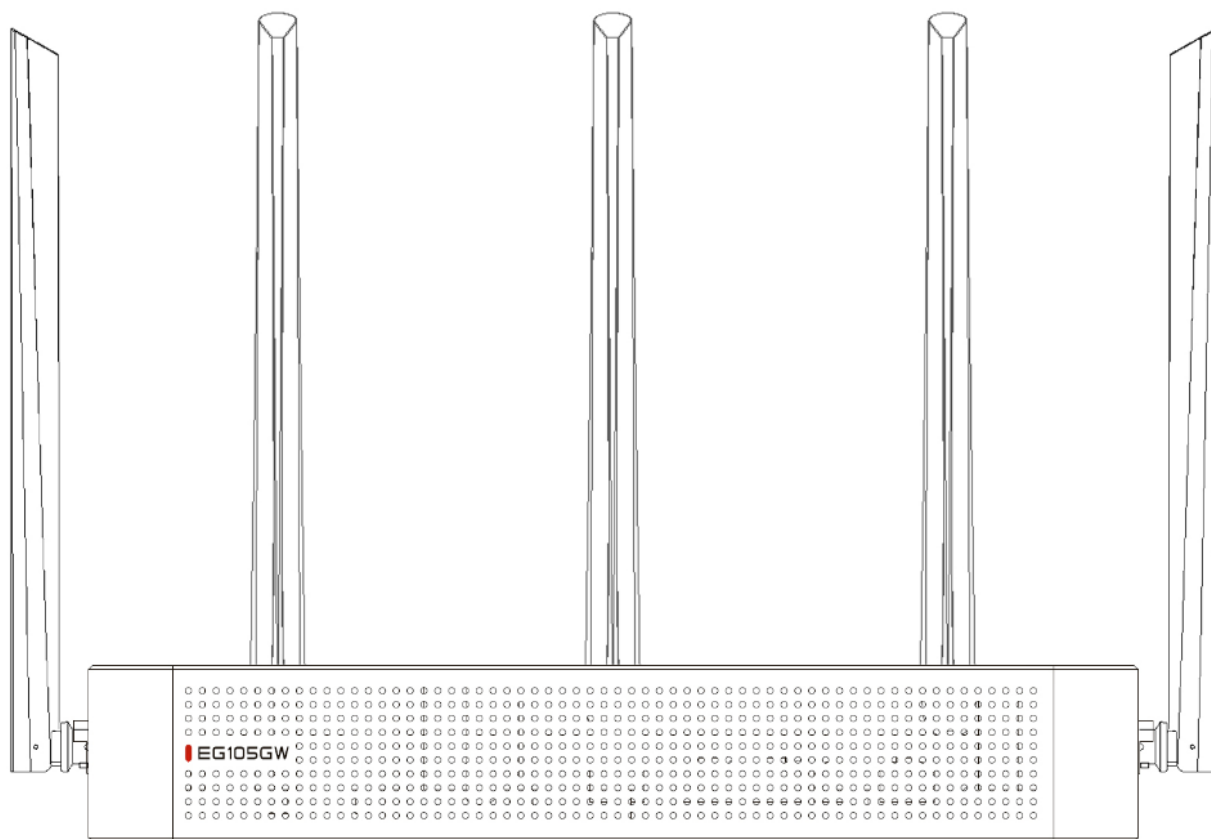
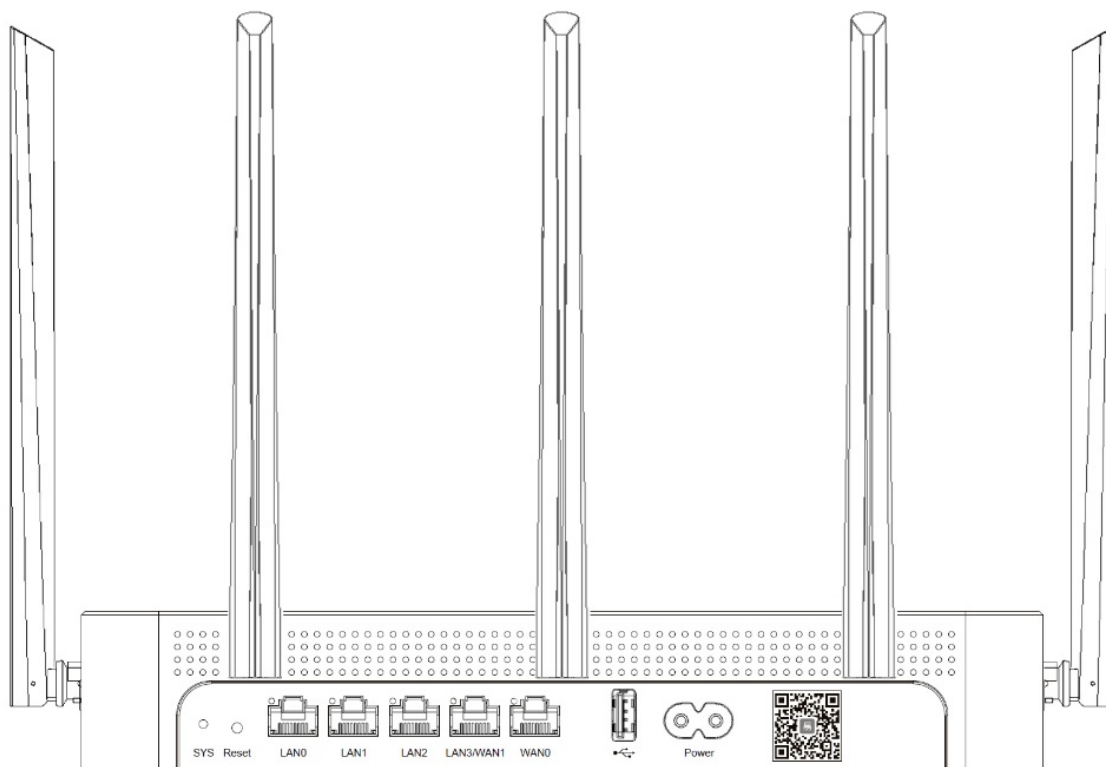

Figure 1-6 Back Panel of RG-EG105GW



Interface

Interface	Description
WAN	1 WAN port, used to connect to the DSL/Cable modem for Internet access.
LAN	4 LAN ports, used to connect the computer to the switch. The LAN3 port can be used as a WAN port via the Web configuration.

LED Indicator

LED Indicator	Description
SYS	Blinking green (0.5Hz): The device has started up, but is not connected to the Ruijie Cloud. Solid green: The device has started up, and is connected to the Ruijie Cloud. Blinking green (10Hz): The device is starting up/shutting down.
Speed	Solid green: the port is connected at 10/100/1000 Mbps. Off: the port is not connected at 10/100/1000 Mbps.

Button



Button	Description
Reset	Press reset button until the status LED blinks green at 10Hz to restore the device to the factory default setting. The default management IP address is http://192.168.110.1 .

1.4 RG-EG210G-P

Specifications

Model	RG-EG210G-P
Storage	DDR3 SDRAM: 256MB ROM: 16MB
Power Module	External 80W power adapter
Interface Standard	Ethernet: 10Base-T/100Base-TX/1000Base-TX
Dimension (without rubber pads) (W x H x D)	202 mm x 28 mm x 108 mm (7.95 in. x 1.1 in. x 4.25 in.)
Voltage	100V to 240V~, 50/60Hz, 1.5A max.
Power Consumption	Less than 80W (With PoE)
PoE	IEEE 802.3af/at, 70W max. output
Working Temperature	0°C to 40°C (32°F to 104°F)

Working Humidity	10% to 90% RH (non-condensing)
-------------------------	--------------------------------

-  Please avoid the vibration and collision in the process of moving and usage.
-  Products should be transported in original package.
-  RG-EG210G-P is a Class-A product which may cause radio interference in the living environment. In such a case, the user may need to take feasible measures against such interference.

Appearance

Figure 1-7 Front Panel of RG-EG210G-P

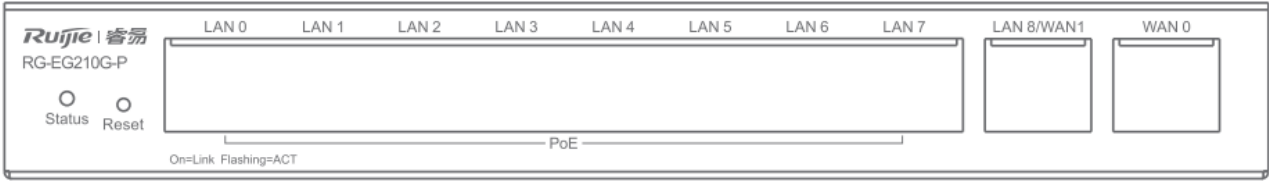
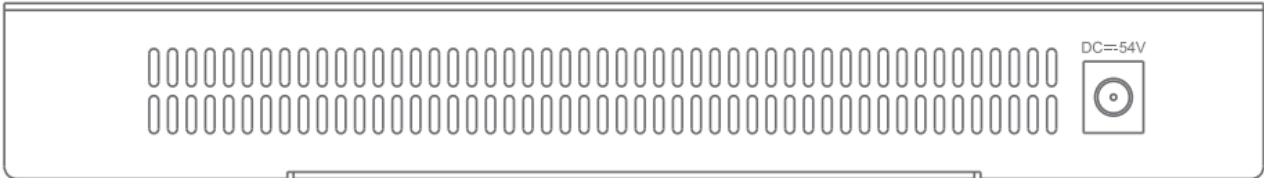

Figure 1-8 Back Panel of RG-EG210G-P



Interface

Interface	Description
WAN	1 WAN port, used to connect to the DSL/Cable modem for Internet access.
LAN	9 LAN ports, used to connect the computer to the switch or access point (AP). The LAN8 port can be used as a WAN port via the Web configuration.

LED Indicator

LED Indicator	Description
Status	Blinking green (0.5Hz): The device has started up, but is not connected to the Ruijie Cloud. Solid green: The device has started up, and is connected to the Ruijie Cloud. Blinking green (10Hz): The device is starting up/shutting down, or PoE overload occurs.
Link/ACT	Solid green: the port is up. Blinking green: data is being transceived on the port.

Button

Button	Description
--------	-------------

Reset	Press reset button until the status LED blinks green at 10Hz to restore the device to the factory default setting. The default management IP address is http://192.168.110.1 .
-------	----------------------------------------------------------------------------------------------------------------------------------------------------------------------------------------------------------------------

2 Preparation

2.1 Safety Precaution

The router acts as the critical transfer station of network connections, and its normal service is crucial to the normal operation of the entire network.

- Do not place the device in a watery place and prevent any liquid from entering into it.
- Keep the device away from heat sources.
- Ensure the normal grounding of device.
- Wear an anti-static wrist strap to install and maintain the device.
- Do not wear loose clothes to avoid hooking any parts. Before operation, tighten your band, shawl and sleeves.
- Keep tools and parts away from the walkway to avoid damage.
- Use the uninterruptible power supply (UPS) to avoid power failure and other interferences.
- If the system time is incorrect, check whether you have set the clock. If the clock is not set, the time may not be correct; if the clock has been set precisely and the time is still incorrect, the built-in button cell of device may have ran out, which is typically happened after 10-year service.
- Install and use the device in restricted access locations.

 Use of wrong battery may cause damage to the device. Do not replace the battery by yourself. Please contact the technical support for help.

 Install and use the device in restricted access locations.

 Invite professionals and related technicians to install this type of device.

 Where a plug on the power supply cord is used as the disconnect device, the installation instructions shall state that for pluggable equipment, the socket-outlet shall be easily accessible. For pluggable equipment intended for installation by an ordinary person, the installation instructions shall be made available to the ordinary person.

2.2 Installation Environment

Ruijie EG series router products are for indoor use only. To ensure normal operation and prolong their service life, the installation site must meet the following requirements:

2.2.1 Temperature/humidity requirements

To ensure normal operation and prolong the service life of the device, the equipment room must maintain constant temperature and humidity. If the equipment room is overheated for a long time, the insulation materials may result in defective insulation and even electric leakage. If the relative humidity is low, the insulation spacer may result in dry shrinkage, which will make screws looser and easily generate static electricity in the dry environment, thus damaging the interior circuits on the device. Excessively high temperature will accelerate the aging of insulation materials and

compromise the reliability and even service life of the device. The temperature/humidity requirements are shown below (detailed difference between products is described in *Product Overview*):

Temperature	Relative Humidity
0°C to 40°C (32°F to 104°F)	10% to 90%

- i** The temperature/humidity of working environment indicates the value measured at 1.5 m above the floor and 0.4 m ahead of the equipment frame when there is no protection plate on the front and rear side of the equipment frame.

2.2.2 Cleanliness

The dust is also a major threat to the safe operation of device. The dust accumulated on the device may cause electrostatic adsorption and result in poor contact. It will not only compromise the service life of device but also cause communication failure. When the indoor relative humidity is low, such electrostatic adsorption will occur more easily.

Maximum Diameter (μm)	0.5	1	3	5
Maximum Density (Particles/ m^3)	1.4×10^7	7×10^5	2.4×10^5	1.3×10^5

Apart from the dust, the device is also sensitive to the hydrochloric acid sulfide contained in the air. These noxious gases will accelerate metal wastage and the aging of certain parts. The upper limits of noxious gases (Sulfur dioxide, Sulfured hydrogen, Nitrogen dioxide, Ammonia and Chlorine) in the following table:

Gas	Average (mg/m^3)	Maximum (mg/m^3)
SO ₂	0.2	1.5
HS	0	0.03
NO ₂	0.04	0.15
N ₂	0.05	0.15
Cl ₂	0.01	0.3

2.2.3 ESD

The router has already given consideration to electrostatic prevention during circuit design, but excessively strong static electricity will still damage the circuit board. The static electricity in the communication network connected with the device is mainly from:

- Outdoor high-voltage transmission line, lightning and other exterior electric fields.
- Indoor environment, flooring material, complete appliance structure and other in-house systems.

To avoid the damage caused by static electricity, we shall:

- Properly ground the device and floor.
- Apply indoor dust control.
- Maintain proper temperature and humidity.
- Before touching the circuit board, wear an anti-static wrist strap and an anti-static uniform.
- Place the circuit board disassembled face up on the antistatic workbench or in the electromagnetic shielded bag.
- When observing or transferring the circuit board of router, touch the outer edge of circuit board and avoid direct contact with the components on the circuit board.

2.2.4 Anti-Interference

The interference as mentioned herein refers to electromagnetic or electrical interference, and the anti-interference requirements are described below:

- Effective power grid interference control measures shall be taken against the power supply system.
- The working ground of the router shall be kept far away from the grounding device or lightning grounding device of power equipment instead of sharing.
- The router shall be kept far away from high-power radio-transmitting station, radar-transmitting station and other high-frequency & heavy-current devices.
- Electromagnetic shielding measures shall be taken whenever necessary.

2.2.5 Installation Site

No matter the router is installed in the cabinet or on the workbench, the following requirements shall be met:

- Make sure sufficient room has been reserved for the air intake and air vent of router to facilitate the heat elimination of the router chassis. It is recommended to install the router in the 19-inch standard cabinet. Otherwise, install it on a clean and flat surface. In heated areas, the air conditioning system shall be equipped.
- Make sure the cabinet and workbench is equipped with a good ventilation and cooling system.
- Make sure the cabinet and workbench is steady enough and capable of withstanding the weight of the router and its accessories.
- Make sure the cabinet and workbench is properly grounded.

2.3 Installation Tools and Devices

Please prepare the following tools and devices:

Installation Tools	Phillips screwdriver, ESD wrist strap
Cables	Power cables, configuration cables, Ethernet cables, grounding wires
Devices	HUB or switch, configuration terminal (PC with hyper-terminal), power socket

3 Installing the Router

3.1 Installation Flowchart

Please take the following steps:

Figure 3-1 Installation Flowchart

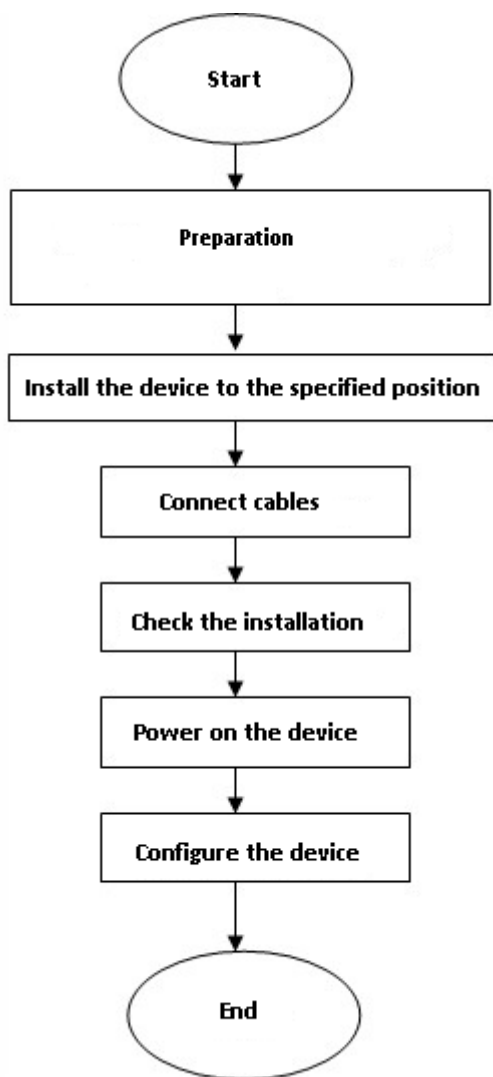

3.2 Mounting the Router

Mounting the router refers to installing the device to the specified position. Upon completion of installation preparation, fix the router to the specified position. The installation position of router is generally a cabinet or a workbench.

Mounting on a Workbench

In most cases, the user does not have a standard cabinet. Instead, the user can place the device on a clean workbench. Although it is easy and simple, you shall pay attention to the following:

- Guarantee the steadiness and good grounding of the workbench.
- Attach the rubber pads onto the small holes at the bottom of the router, and maintain a minimum of 10 cm around the device.
- Do not place heavy things on the device.

3.3 Installing Power Cables

The requirements of Ruijie EG series router products on AC power supply are described below (refer to *Product Overview* for detailed parameters):

100–240 V / 50/60 Hz.

RG-EG series router uses 3-conductor power cables. You are suggested to use a single-phase 3-conductor outlet or a multifunction microcomputer outlet with neutral connector. The neutral point of the power supply shall be securely grounded in the building. In most buildings, the neutral point of a power supply has been grounded during the construction. You need to make sure the power supply is properly grounded.

Please take the following steps:

- Plug one end of the power cable into the power socket on the backpanel of the router, and plug the other end into the AC power supply outlet.
- Check whether the power LED on the front panel of the router lights up or not. The LED indicator will light up if the power supply is properly connected.

3.4 Checking after the Installation

After completing the mechanical installation of router, perform the following checks before powering on the device:

- If the device is installed in a cabinet, check whether the angle bar for device installation is steady. If the device is installed on the workbench, check whether sufficient room is reserved around the device to ensure heat elimination and whether the workbench is steady.
 - Check whether the power supply meets the requirements.
 - Check whether the earth wire of device is properly connected.
 - Check whether the device is connected correctly to the configuration terminal.
-

4 Quick Configuration

4.1 Connecting Devices

Connecting to AP

1. Connect the AP device to the EG router via network cable.
2. Power on the devices.
3. The AP device broadcasts an SSID with a prefix starting with @Ruijie-m.

Connecting to PC

1. Connect the PC to the EG router via network cable.
2. Enable the PC to automatically obtain the IP address.

4.2 Power-on Startup

Checks before Power-on

Before power-on, perform the following checks on the router:

- Whether the power cable and the ground wire are properly connected.
- Whether the power voltage is consistent with the requirement of the router.
- Whether the configuration cable is properly connected, and whether the microcomputer or terminal for device configuration is started or configured.

 Before powering on the router, be aware of the location of the power switch of the router to timely cut off power supply in case of any accident.

Powering on the Router

- Turn on the power supply switch of the router.

Checks after Power-on

After the router is powered on, check the following items:

- Whether the LED indicators on the front panel of the router works normally.

Refer to the indicators in *Product Overview*.

- Whether the Web-based system is available.

The default management IP address is `http://192.168.110.1`.

4.3 Configuring Router

To use the router, you need to properly configure the router as required. Refer to the relevant Web-based configuration guide for details about router configuration.

5 Troubleshooting

5.1 Power Supply

Refer to *Product Overview* for the normal state descriptions of LED indicators. If abnormality occurs, perform the following checks:

- Whether the power switch is turned on.
- Whether the power supply of the router is turned on.
- Whether the power cable is properly connected.
- Whether the power supply to the router meets relevant requirements.

 Do not plug or pull the power cable when the device is powered on. If everything is ok but the Status LED still does not light up, contact with a local distributor or technical support personnel.

5.2 Configuration System

After the router is powered on, the Web-based configuration system is available if the device works normally. If not, please check:

- Whether the power system works normally.
- Whether the network cable is properly connected.
- Whether the network card of the computer is using DHCP to obtain the IP address.

DISTRIBUTED BY



Powertec Wireless Technology | 16/511 Olsen Ave, Southport Qld 4215 Australia
P +61 7 5577 0500 | NZ +64 9 951 6205 | E sales@powertec.com.au | W www.powertec.com.au