

2J7B83Bc

4× 5GNR MIMO Screw Mount

Key Features

Cable 1 - 4: 5GNR

- 617-960 MHz
- 1427-2690 MHz
- 3300-5000 MHz
- 5150-5925 MHz

Screw Mount

Heavy Duty antenna

High Performance

Ground Plane Independent

Anti-Rotation Mounting

Customizable Cable and Connector

Dimensions: Ø 96 x H 130 mm

Certificates: IP67, IP69, IK09

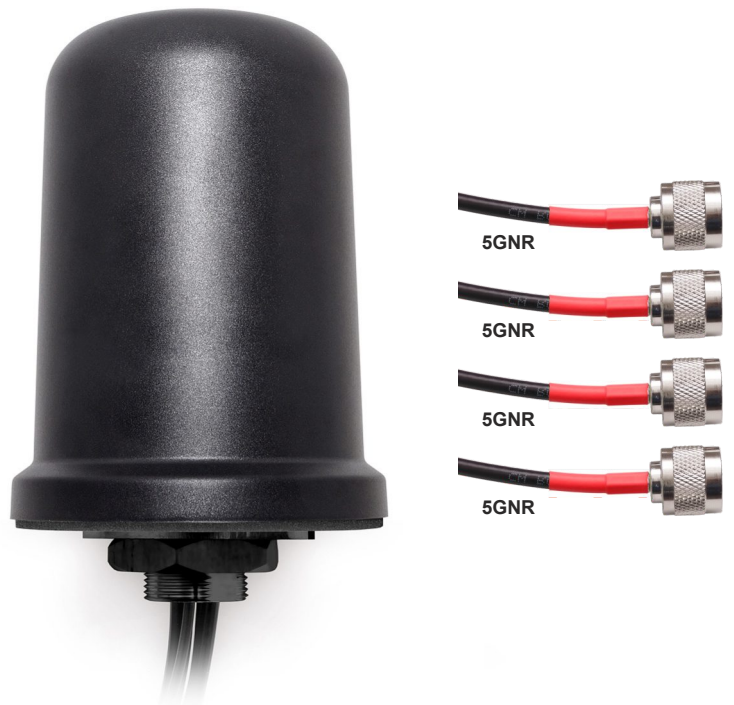

1. Antenna and electrical specifications

Cable 1

| Parameters | 5G NR Antenna | | | |
|----------------------|---|---|---------------------------------|----------------------|
| Technologies | 5G, 4G, 3G and 2G | | | |
| Standards | 5G NR/4GLTE/FirstNet/CBRS/LPWA/CAT-X/CAT-Mx/CAT-NBx/NB-IoT/3G/2G | | | |
| Frequency (MHz) | 617-960 | 1427-2690 | 3300-5000 | 5150-5925 |
| Band (MHz) | 600, 700, 850, 900 | 1500, 1600, 1700, 1800, 1900, 2000, 2100, 2300, 2500, 2600 | 3300, 3500, 3600, 3700, 4500 | 5200, 5500, 5800 |
| 5G NR Bands | n5, n8, 12, n20, n28, n71, n81, n82, n83, | n1, n2, n3, n7, n25, n34, n38, n39, n40, n41, n50, n51, n66, n70, n74, n75, n76, n80, n84, n86 | n77, n78, n79 | |
| 4GLTE Bands | B5, B6, B8, B12, B13, B14, B17, B18, B19, B20, B26, B27, B28, B29, B44, B67, B68, B71, B85 | B1, B2, B3, B4, B7, B9, B10, B11, B21, B23, B24, B25, B30, B32, B33, B34, B35, B36, B37, B38, B39, B40, B41, B45, B50, B51, B65, B66, B69, B70, B74, B75, B76 | B22, B42, B43, B48, B49, B52 | B46, B47, B252, B255 |
| 3GCELL Bands | B5, B6, B8, B12, B13, B14, B19, B20, B26 | B1, B2, B3, B4, B7, B9, B10, B11, B21, B25, B32, B33, B34, B35, B36, B37, B38, B39, B40 | B22 | |
| 2GCELL Bands | 710, 750, 810T, 850, 900P, 900E, 900R | 1800DCS, 1900PCS | | |
| CDMA CELL Bands | BC0, BC2, BC3, BC7, BC9, BC10, BC12, BC18, BC19 | BC1, BC4, BC6, BC8, BC13, BC14, BC15, BC16, BC20, BC21 | | |
| Return Loss (dB) | ~-5.6 | ~-11.7 | ~-15.2 | ~-14.2 |
| VSWR | ~3.5:1 | ~1.9:1 | ~1.5:1 | ~1.6:1 |
| Efficiency (%) | ~32.0 | ~41.4 | ~41.7 | ~36.9 |
| Peak Gain (dBi) | ~1.3 | ~3.4 | ~4.8 | ~4.0 |
| Average Gain (dB) | ~-5.0 | ~-3.9 | ~-3.8 | ~-4.4 |
| Impedance (Ohm) | 50 | | | |
| Polarisation | Linear | | | |
| Radiation Pattern | Omni-Directional | | | |
| Max. Input Power (W) | 35 | | | |
| Connector Type | SMA-Male Standard (Other Connectors Available) | | | |
| Cable Length | 300 cm Standard (Any Cable Length Available) | | | |
| Cable Type | LL195 Standard (Other Cables Available) | | | |

Cable 2

| Parameters | 5GNR Antenna | | | |
|----------------------|---|---|---------------------------------|----------------------|
| Technologies | 5G, 4G, 3G and 2G | | | |
| Standards | 5GNR/4GLTE/FirstNet/CBRS/LPWA/CAT-X/CAT-Mx/CAT-NBx/NB-IoT/3G/2G | | | |
| Frequency (MHz) | 617-960 | 1427-2690 | 3300-5000 | 5150-5925 |
| Band (MHz) | 600, 700, 850, 900 | 1500, 1600, 1700, 1800, 1900, 2000, 2100, 2300, 2500, 2600 | 3300, 3500, 3600, 3700, 4500 | 5200, 5500, 5800 |
| 5GNR Bands | n5, n8 ,12, n20, n28, n71, n81, n82, n83, | n1, n2, n3, n7, n25, n34, n38, n39, n40, n41, n50, n51, n66, n70, n74, n75, n76, n80, n84, n86 | n77, n78, n79 | |
| 4GLTE Bands | B5, B6, B8, B12, B13, B14, B17, B18, B19, B20, B26, B27, B28, B29, B44, B67, B68, B71, B85 | B1, B2, B3, B4, B7, B9, B10, B11, B21, B23, B24, B25, B30, B32, B33, B34, B35, B36, B37, B38, B39, B40, B41, B45, B50, B51, B65, B66, B69, B70, B74, B75, B76 | B22, B42, B43, B48, B49, B52 | B46, B47, B252, B255 |
| 3GCELL Bands | B5, B6, B8, B12, B13, B14, B19, B20, B26 | B1, B2, B3, B4, B7, B9, B10, B11, B21, B25, B32, B33, B34, B35, B36, B37, B38, B39, B40 | B22 | |
| 2GCELL Bands | 710, 750, 810T, 850, 900P, 900E, 900R | 1800DCS, 1900PCS | | |
| CDMACELL Bands | BC0, BC2, BC3, BC7, BC9, BC10, BC12, BC18, BC19 | BC1, BC4, BC6, BC8, BC13, BC14, BC15, BC16, BC20, BC21 | | |
| Return Loss (dB) | ~-6.2 | ~-12.5 | ~-15.1 | ~-16.0 |
| VSWR | ~3.2:1 | ~1.9:1 | ~1.5:1 | ~1.5:1 |
| Efficiency (%) | ~31.8 | ~41.1 | ~42.8 | ~33.1 |
| Peak Gain (dBi) | ~1.2 | ~3.5 | ~4.6 | ~3.2 |
| Average Gain (dB) | ~-5.0 | ~-3.9 | ~-3.7 | ~-4.8 |
| Impedance (Ohm) | 50 | | | |
| Polarisation | Linear | | | |
| Radiation Pattern | Omni-Directional | | | |
| Max. Input Power (W) | 35 | | | |
| Connector Type | SMA-Male Standard (Other Connectors Available) | | | |
| Cable Length | 300 cm Standard (Any Cable Length Available) | | | |
| Cable Type | LL195 Standard (Other Cables Available) | | | |

Cable 3

| Parameters | 5GNR Antenna | | | |
|----------------------|---|---|---------------------------------|----------------------|
| Technologies | 5G, 4G, 3G and 2G | | | |
| Standards | 5GNR/4GLTE/FirstNet/CBRS/LPWA/CAT-X/CAT-Mx/CAT-NBx/NB-IoT/3G/2G | | | |
| Frequency (MHz) | 617-960 | 1427-2690 | 3300-5000 | 5150-5925 |
| Band (MHz) | 600, 700, 850, 900 | 1500, 1600, 1700, 1800, 1900, 2000, 2100, 2300, 2500, 2600 | 3300, 3500, 3600, 3700, 4500 | 5200, 5500, 5800 |
| 5GNR Bands | n5, n8, 12, n20, n28, n71, n81, n82, n83, | n1, n2, n3, n7, n25, n34, n38, n39, n40, n41, n50, n51, n66, n70, n74, n75, n76, n80, n84, n86 | n77, n78, n79 | |
| 4GLTE Bands | B5, B6, B8, B12, B13, B14, B17, B18, B19, B20, B26, B27, B28, B29, B44, B67, B68, B71, B85 | B1, B2, B3, B4, B7, B9, B10, B11, B21, B23, B24, B25, B30, B32, B33, B34, B35, B36, B37, B38, B39, B40, B41, B45, B50, B51, B65, B66, B69, B70, B74, B75, B76 | B22, B42, B43, B48, B49, B52 | B46, B47, B252, B255 |
| 3GCELL Bands | B5, B6, B8, B12, B13, B14, B19, B20, B26 | B1, B2, B3, B4, B7, B9, B10, B11, B21, B25, B32, B33, B34, B35, B36, B37, B38, B39, B40 | B22 | |
| 2GCELL Bands | 710, 750, 810T, 850, 900P, 900E, 900R | 1800DCS, 1900PCS | | |
| CDMACELL Bands | BC0, BC2, BC3, BC7, BC9, BC10, BC12, BC18, BC19 | BC1, BC4, BC6, BC8, BC13, BC14, BC15, BC16, BC20, BC21 | | |
| Return Loss (dB) | ~-5.6 | ~-12.8 | ~-16.7 | ~-12.4 |
| VSWR | ~3.7:1 | ~1.8:1 | ~1.4:1 | ~1.8:1 |
| Efficiency (%) | ~31.7 | ~41.7 | ~40.3 | ~38.5 |
| Peak Gain (dBi) | ~1.3 | ~3.8 | ~4.5 | ~4.6 |
| Average Gain (dB) | ~-5.0 | ~-3.8 | ~-4.0 | ~-4.2 |
| Impedance (Ohm) | 50 | | | |
| Polarisation | Linear | | | |
| Radiation Pattern | Omni-Directional | | | |
| Max. Input Power (W) | 35 | | | |
| Connector Type | SMA-Male Standard (Other Connectors Available) | | | |
| Cable Length | 300 cm Standard (Any Cable Length Available) | | | |
| Cable Type | LL195 Standard (Other Cables Available) | | | |

Cable 4

| Parameters | 5GNR Antenna | | | |
|----------------------|---|---|---------------------------------|----------------------|
| Technologies | 5G, 4G, 3G and 2G | | | |
| Standards | 5GNR/4GLTE/FirstNet/CBRS/LPWA/CAT-X/CAT-Mx/CAT-NBx/NB-IoT/3G/2G | | | |
| Frequency (MHz) | 617-960 | 1427-2690 | 3300-5000 | 5150-5925 |
| Band (MHz) | 600, 700, 850, 900 | 1500, 1600, 1700, 1800, 1900, 2000, 2100, 2300, 2500, 2600 | 3300, 3500, 3600, 3700, 4500 | 5200, 5500, 5800 |
| 5GNR Bands | n5, n8 ,12, n20, n28, n71, n81, n82, n83, | n1, n2, n3, n7, n25, n34, n38, n39, n40, n41, n50, n51, n66, n70, n74, n75, n76, n80, n84, n86 | n77, n78, n79 | |
| 4GLTE Bands | B5, B6, B8, B12, B13, B14, B17, B18, B19, B20, B26, B27, B28, B29, B44, B67, B68, B71, B85 | B1, B2, B3, B4, B7, B9, B10, B11, B21, B23, B24, B25, B30, B32, B33, B34, B35, B36, B37, B38, B39, B40, B41, B45, B50, B51, B65, B66, B69, B70, B74, B75, B76 | B22, B42, B43, B48, B49, B52 | B46, B47, B252, B255 |
| 3GCELL Bands | B5, B6, B8, B12, B13, B14, B19, B20, B26 | B1, B2, B3, B4, B7, B9, B10, B11, B21, B25, B32, B33, B34, B35, B36, B37, B38, B39, B40 | B22 | |
| 2GCELL Bands | 710, 750, 810T, 850, 900P, 900E, 900R | 1800DCS, 1900PCS | | |
| CDMACELL Bands | BC0, BC2, BC3, BC7, BC9, BC10, BC12, BC18, BC19 | BC1, BC4, BC6, BC8, BC13, BC14, BC15, BC16, BC20, BC21 | | |
| Return Loss (dB) | ~-5.9 | ~-12.7 | ~-16.8 | ~-15.4 |
| VSWR | ~3.3:1 | ~1.8:1 | ~1.5:1 | ~1.5:1 |
| Efficiency (%) | ~31.4 | ~41.8 | ~42.7 | ~35.0 |
| Peak Gain (dBi) | ~1.7 | ~3.4 | ~4.6 | ~3.9 |
| Average Gain (dB) | ~-5.1 | ~-3.8 | ~-3.7 | ~-4.6 |
| Impedance (Ohm) | 50 | | | |
| Polarisation | Linear | | | |
| Radiation Pattern | Omni-Directional | | | |
| Max. Input Power (W) | 35 | | | |
| Connector Type | SMA-Male Standard (Other Connectors Available) | | | |
| Cable Length | 300 cm Standard (Any Cable Length Available) | | | |
| Cable Type | LL195 Standard (Other Cables Available) | | | |

Antenna Measurement Conditions:

Mounted on Metal Plate of 30 x 30 cm
 200 cm of Cable LL195
 Measured in Certified CTIA 3D Anechoic Chamber

2. Mechanical and environmental specifications

| Specifications | 2J7B83Bc |
|----------------------------------|------------------|
| Mounting Type | Screw Mount |
| Dimensions (mm) | Ø 96 x H 130 |
| Max. Tighten Torque (Nm) | 6 Nm |
| Radome | ASA |
| Radome color | White, Black |
| Antenna Base | ASA |
| Operating Temperature (C) | -40 to +85 |
| Storage Temperature (C) | -40 to +85 |
| Substance Compliance | RoHS |
| Certificates | IP67, IP69, IK09 |

3. Antenna parameters

Cable 1: 5GNR

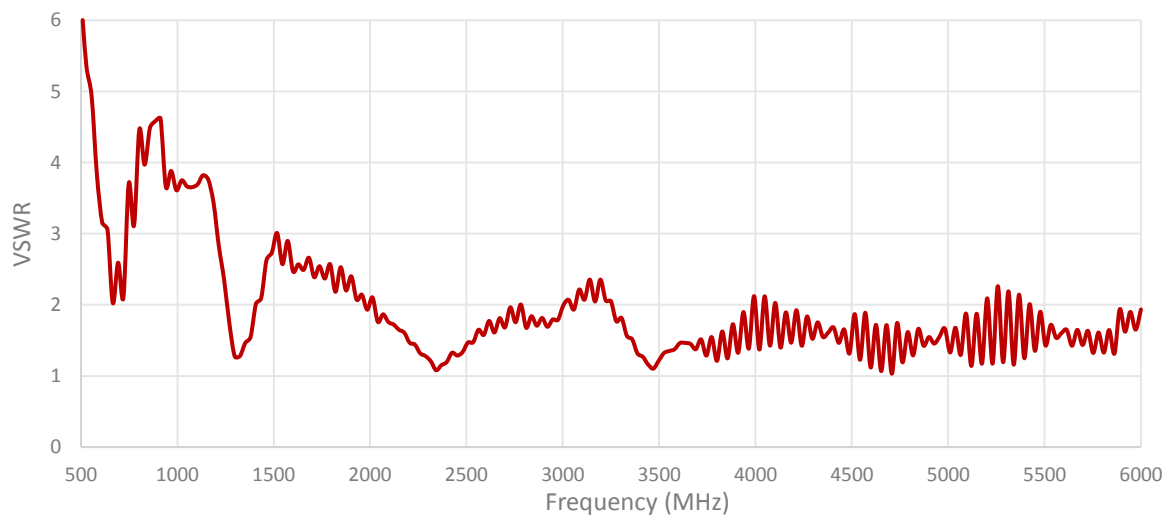
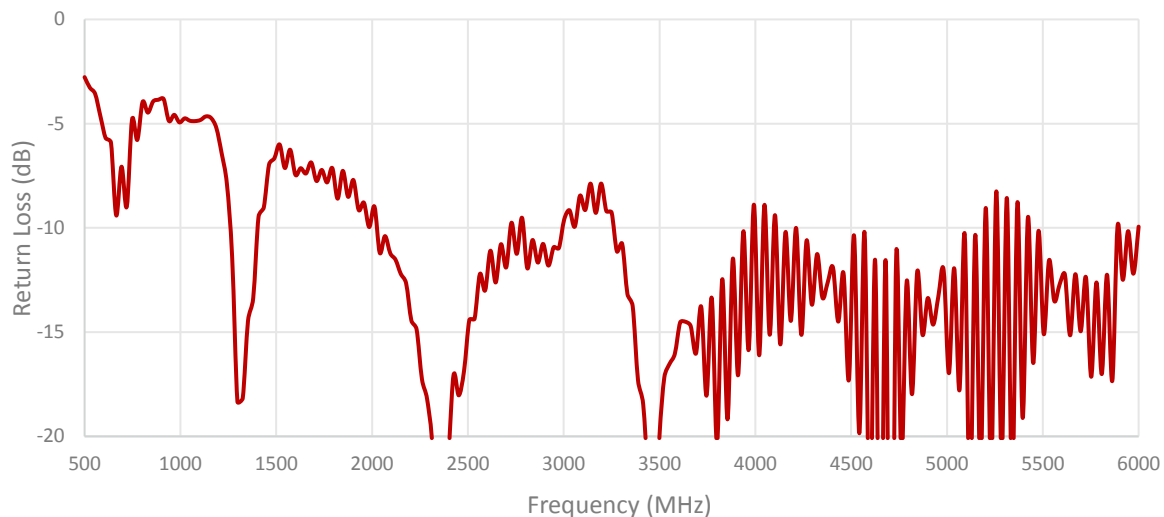

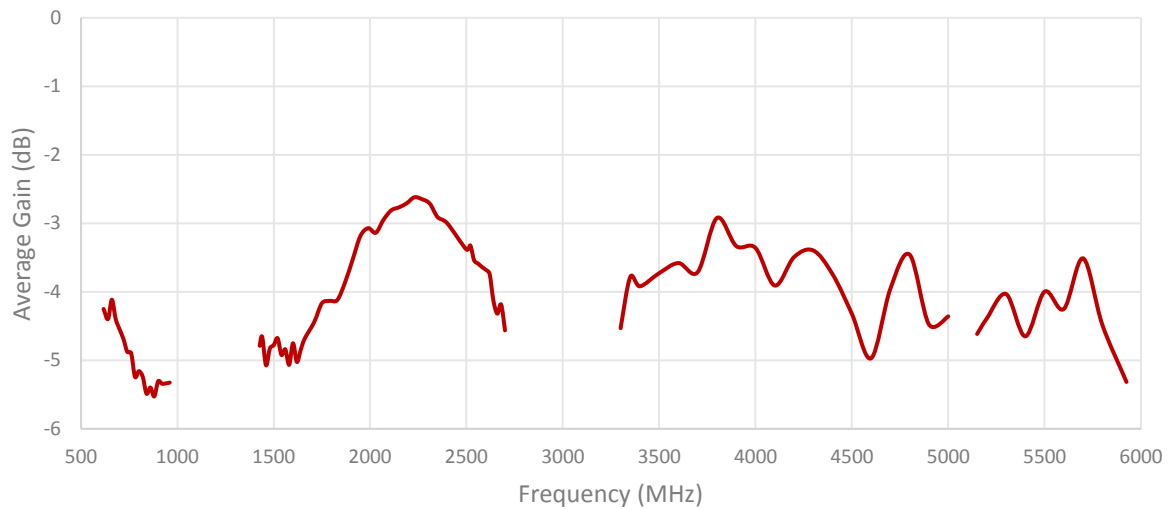
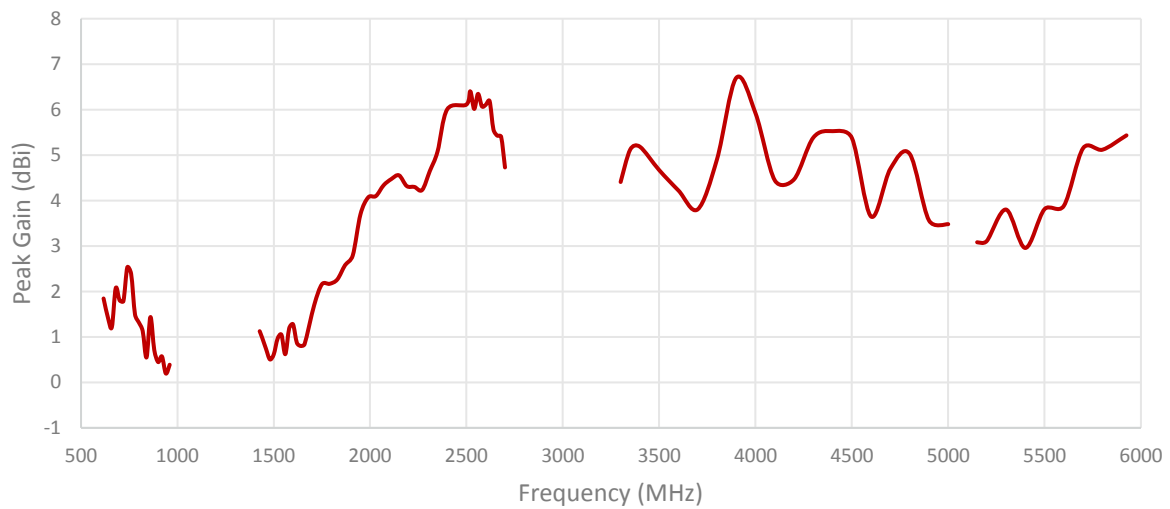
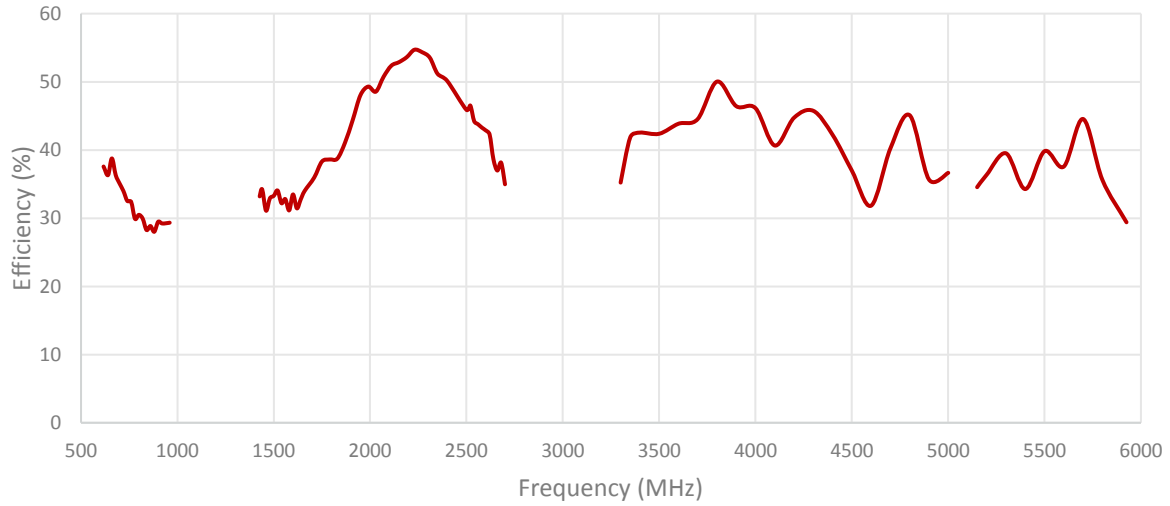

Cable 2: 5GNR

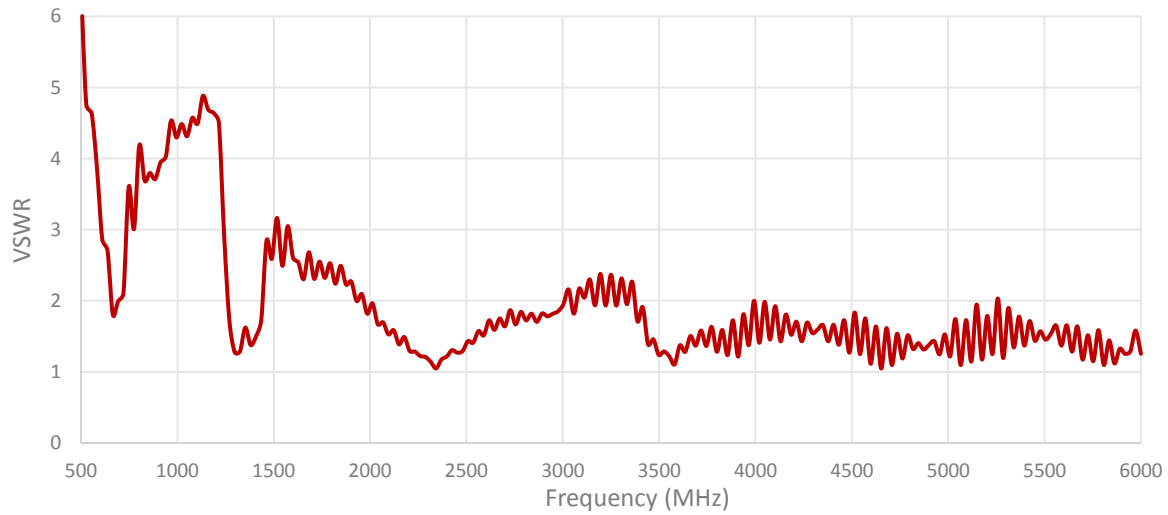
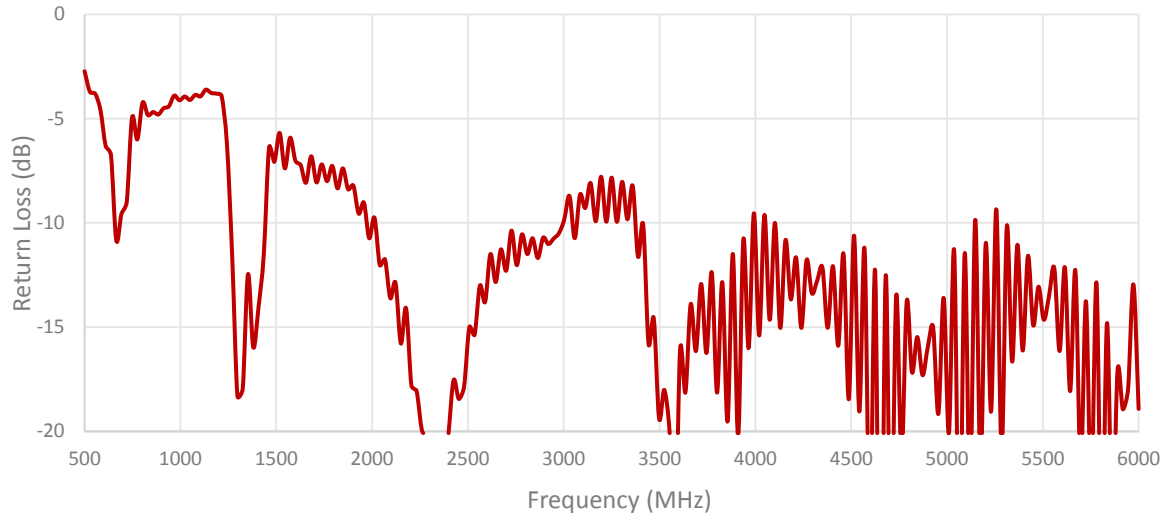

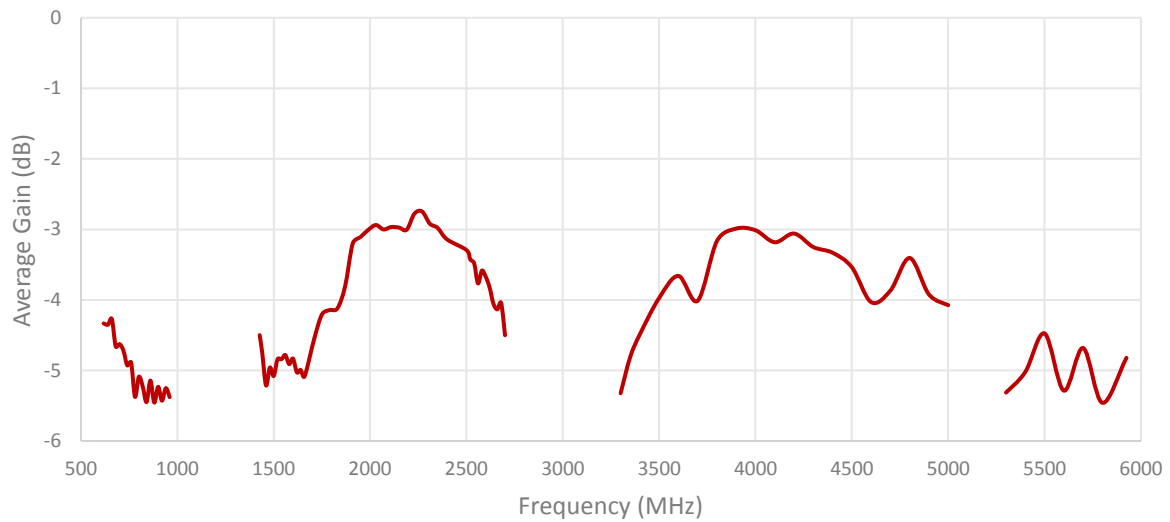
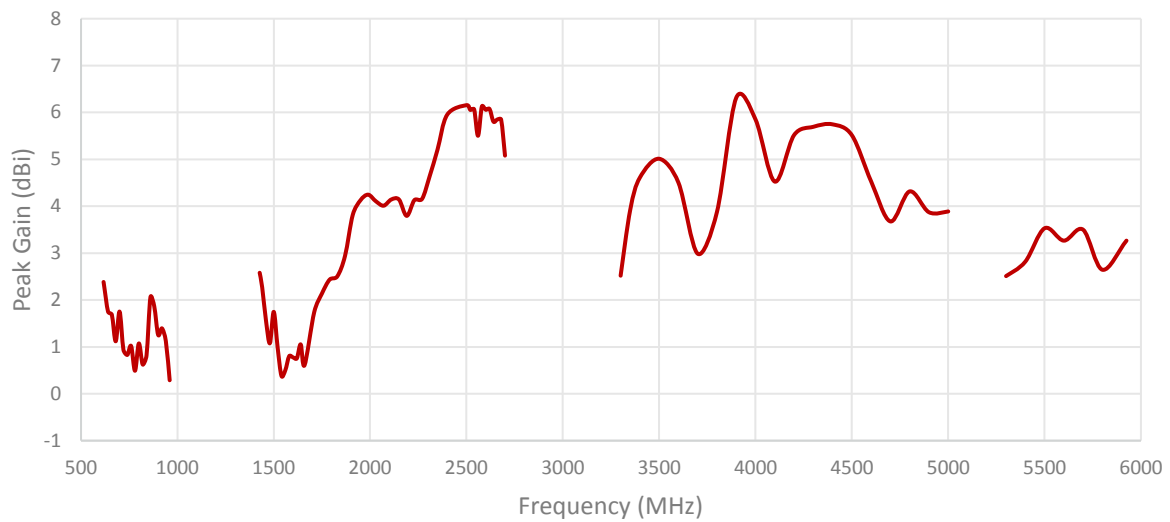
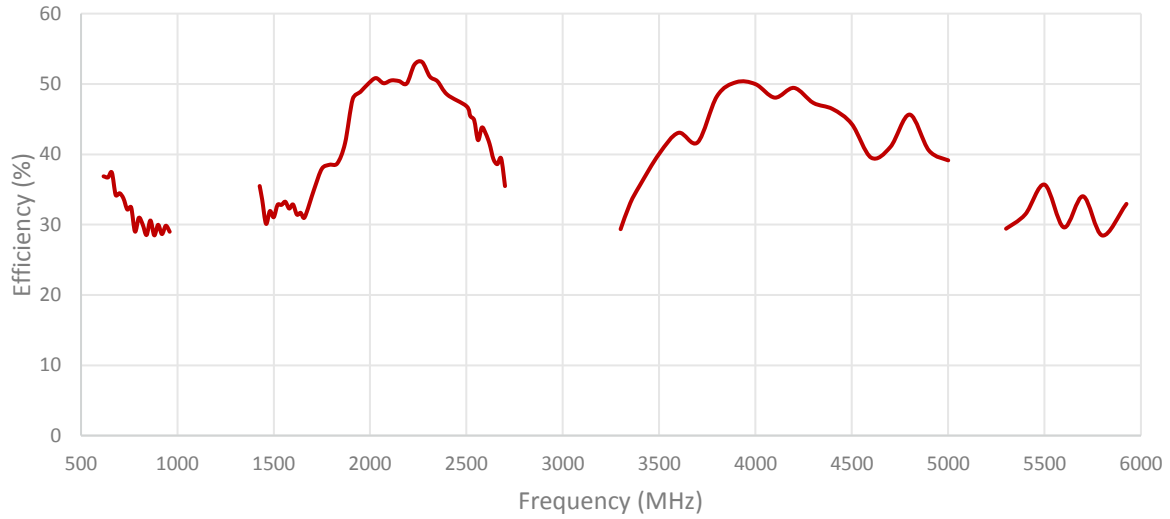

Cable 3: 5GNR

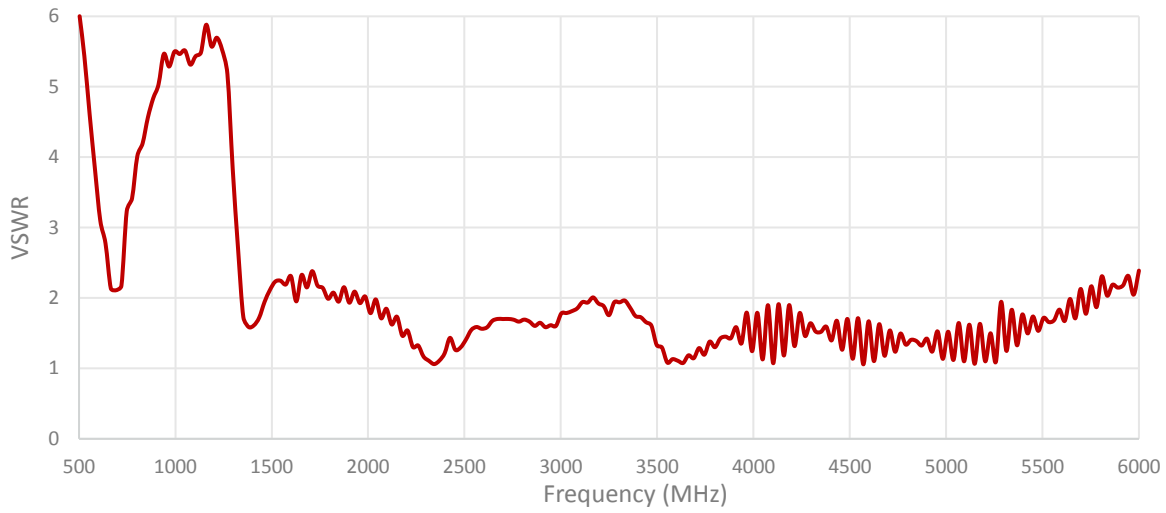
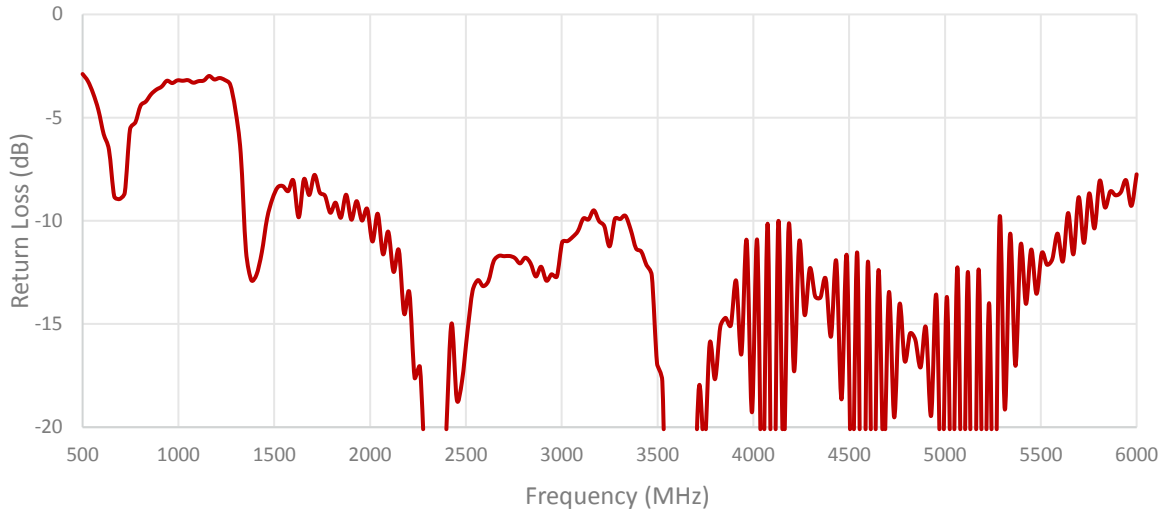

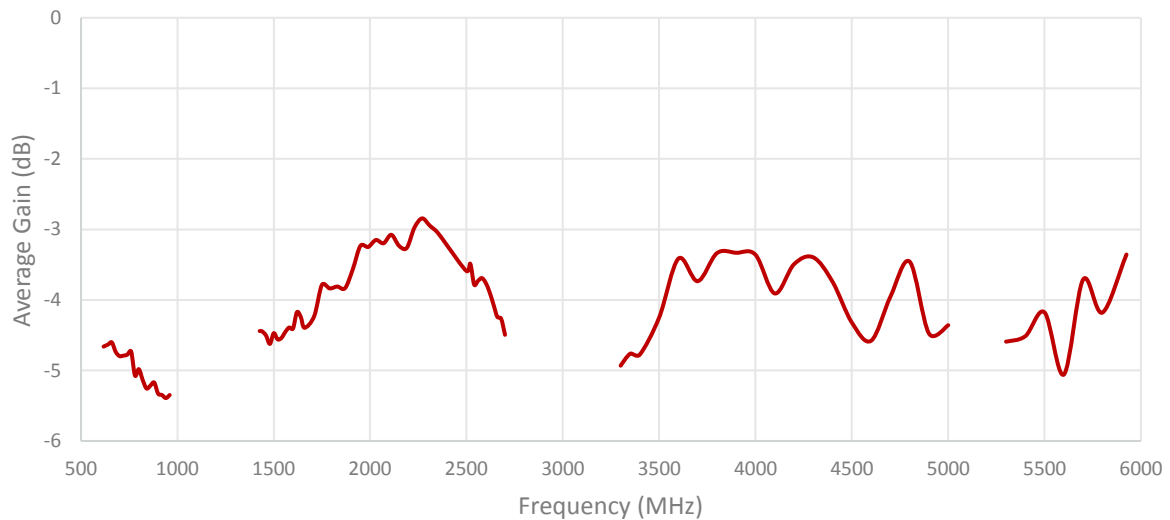
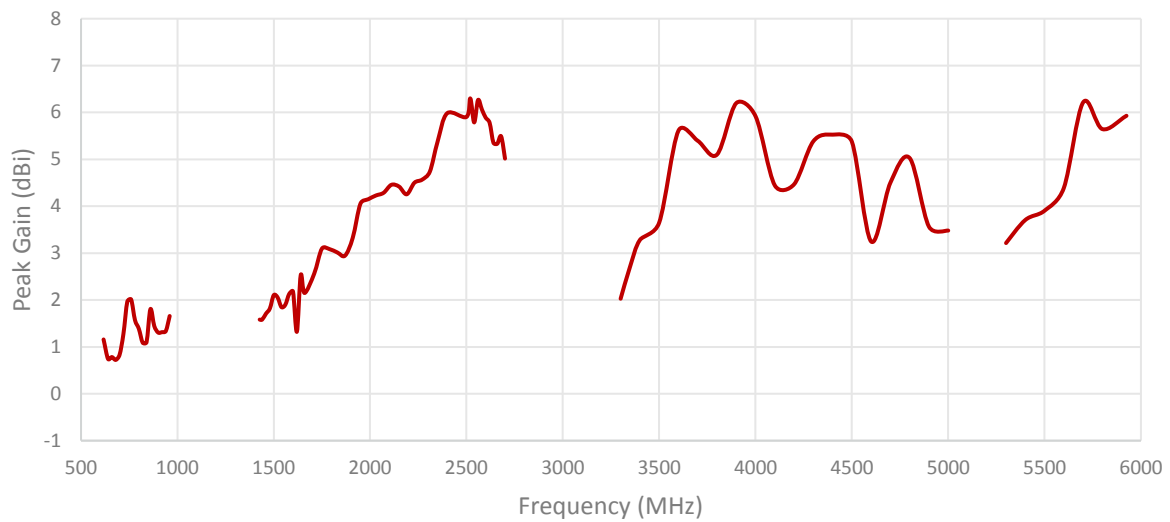
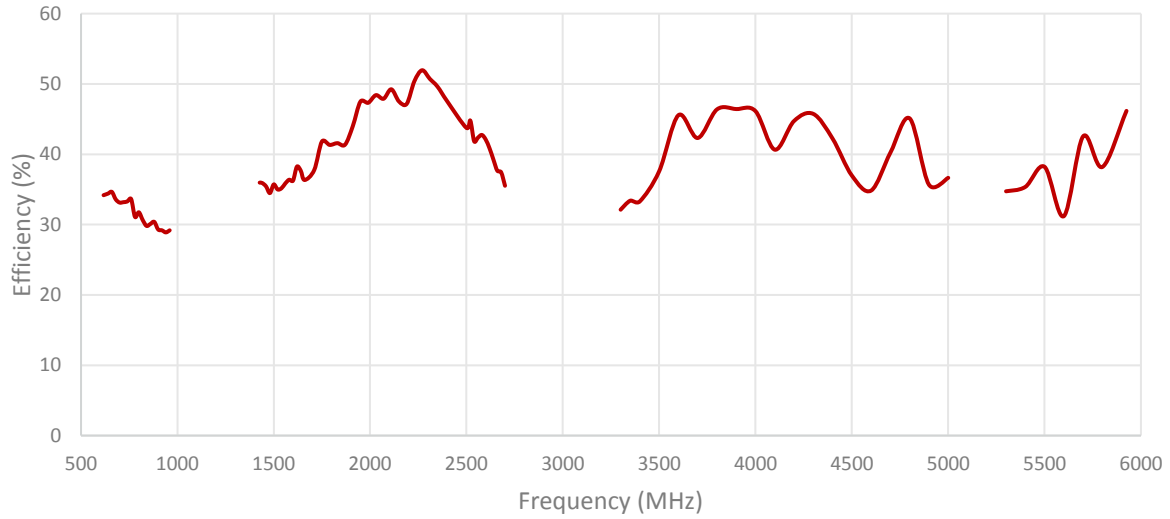

Cable 4: 5GNR

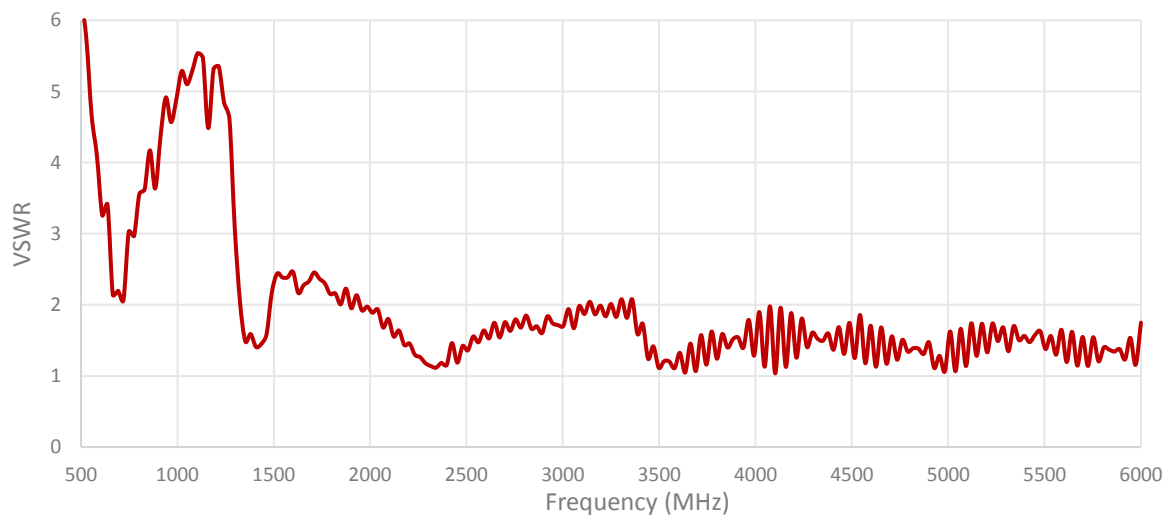
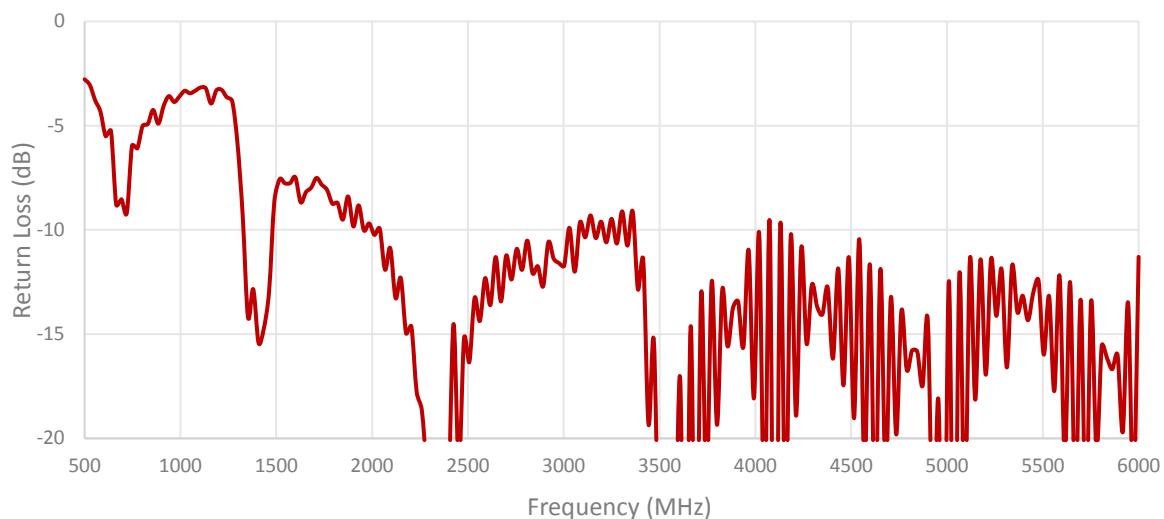

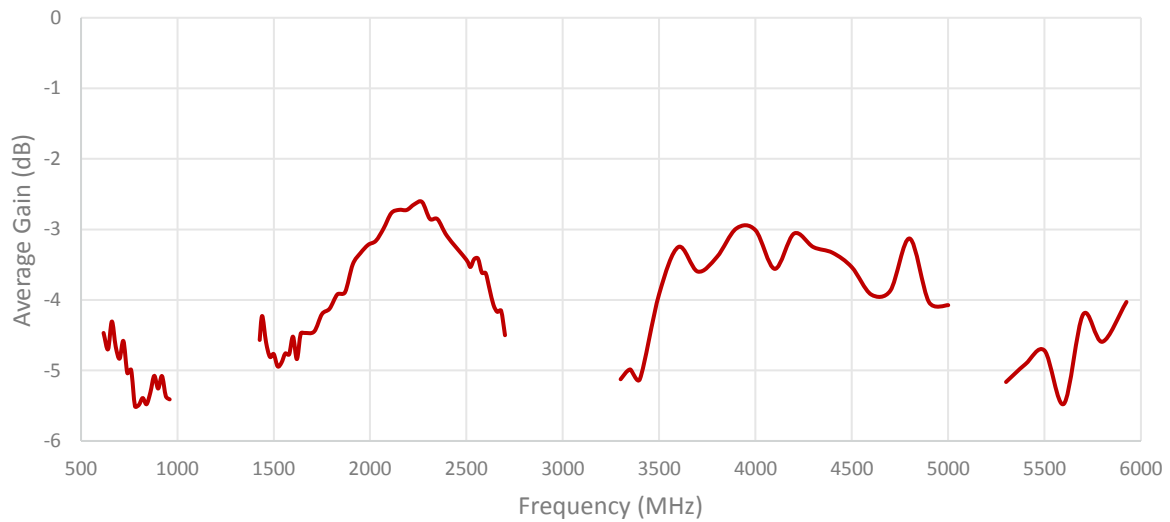
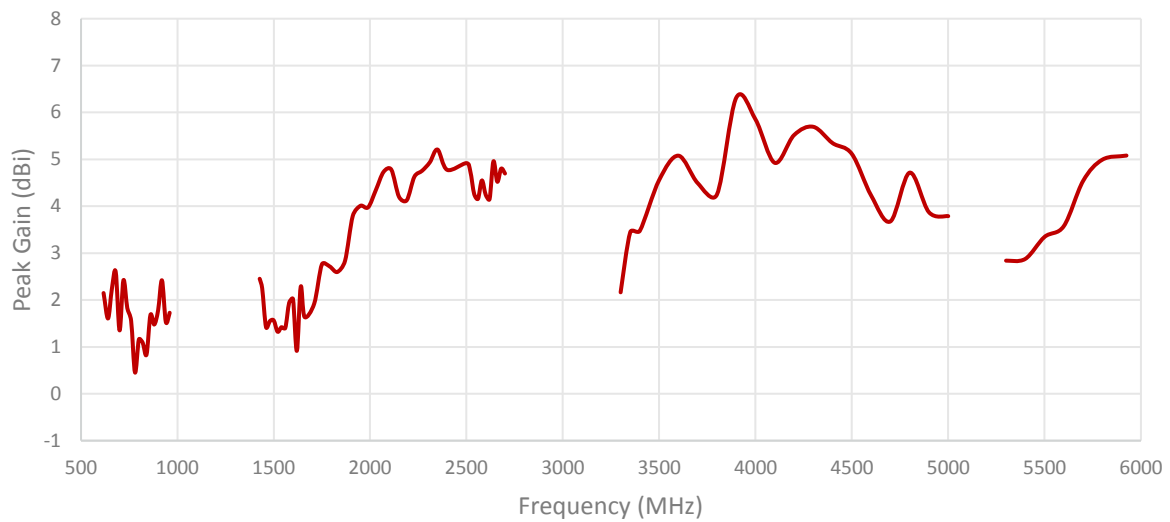
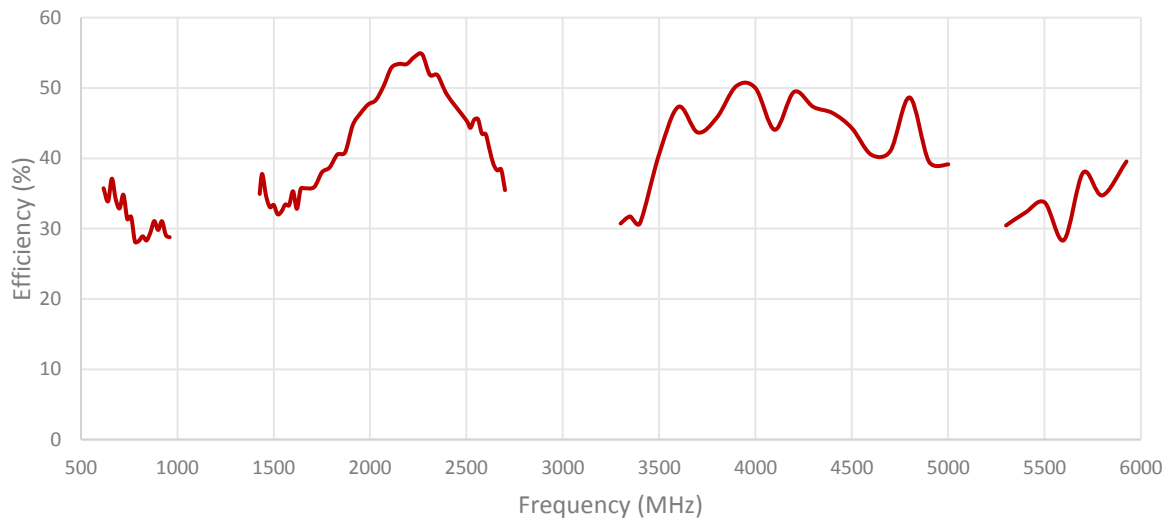

ISOLATION FOR CABLES 1 AND 2

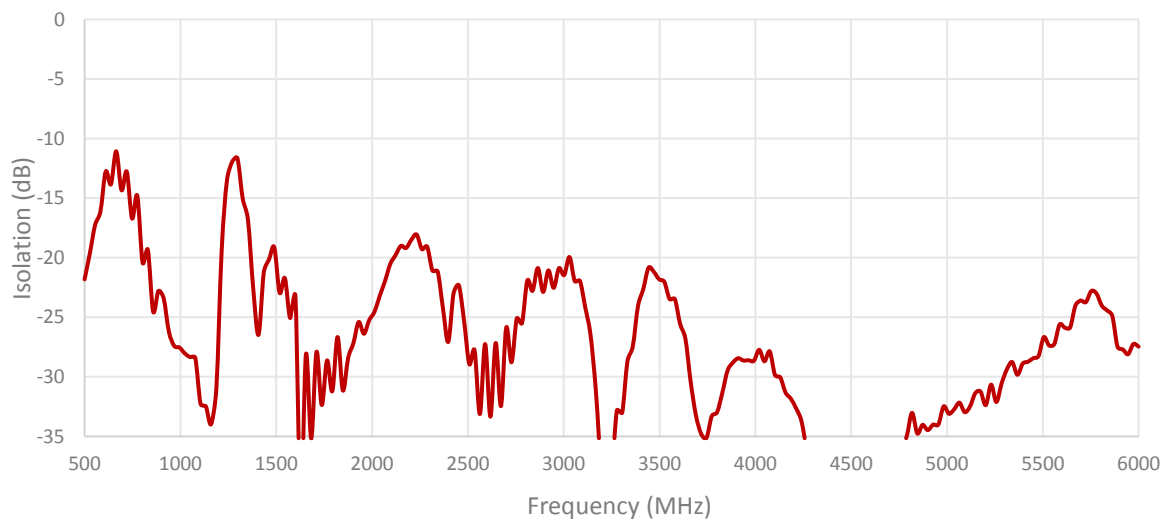

ISOLATION FOR CABLES 1 AND 3

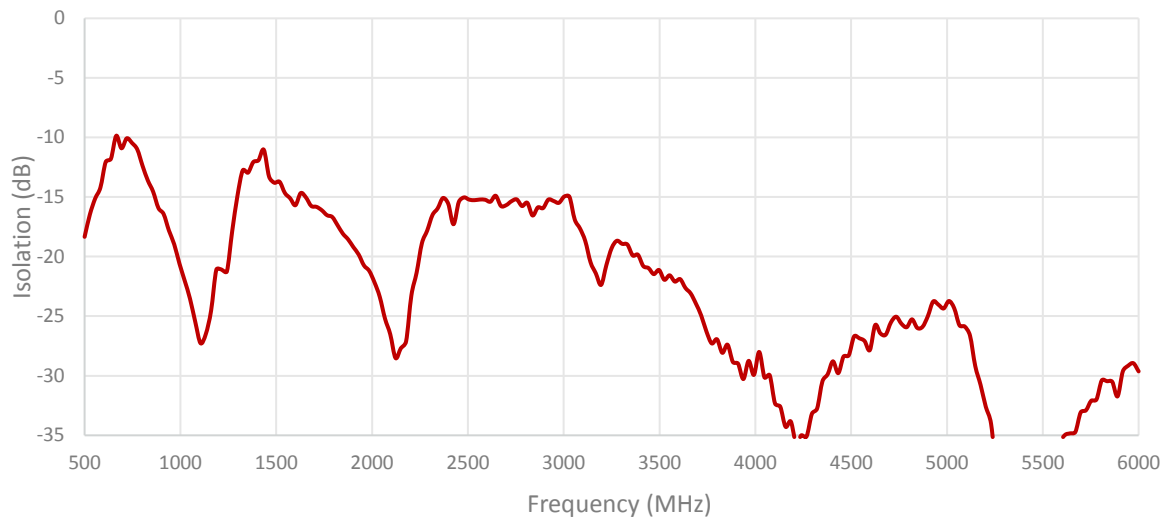

ISOLATION FOR CABLES 1 AND 4

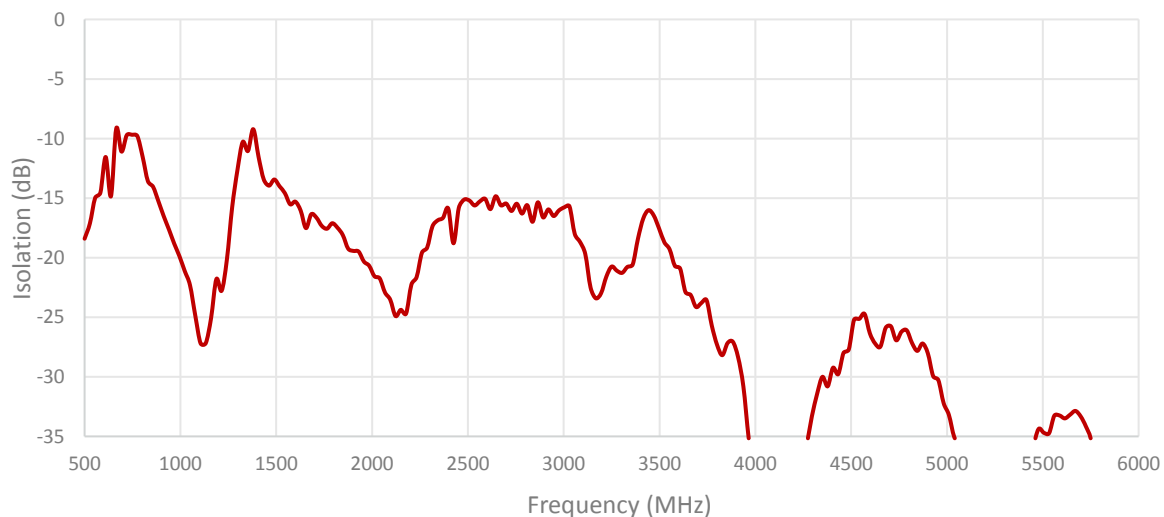

ISOLATION FOR CABLES 2 AND 3

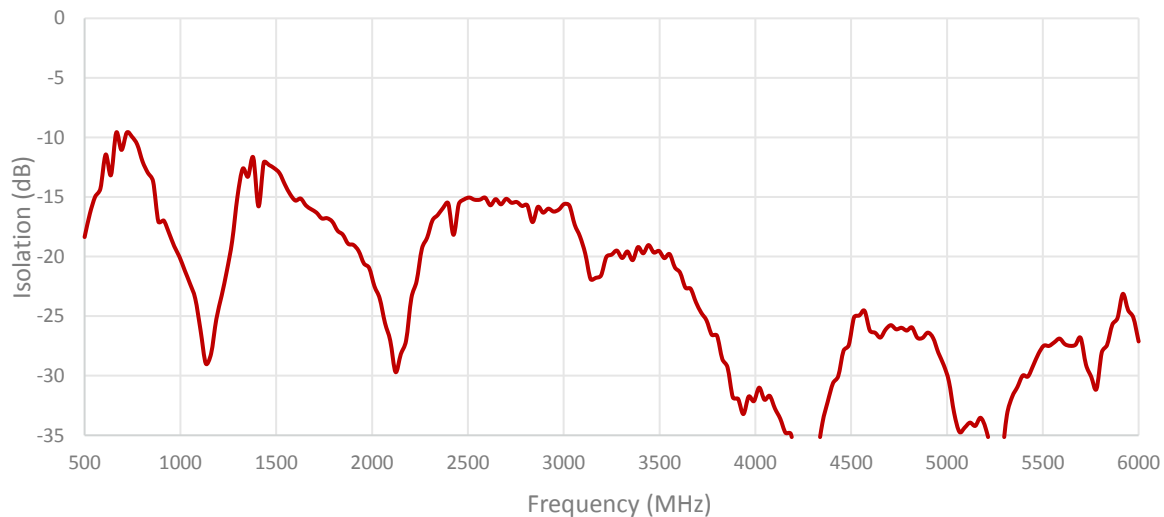

ISOLATION FOR CABLES 2 AND 4

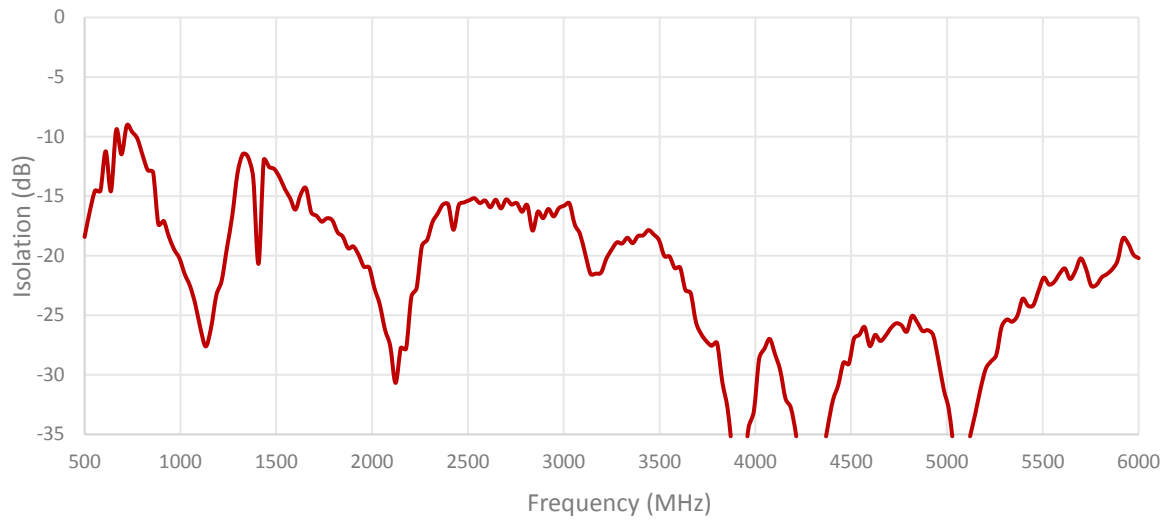

ISOLATION FOR CABLES 3 AND 4

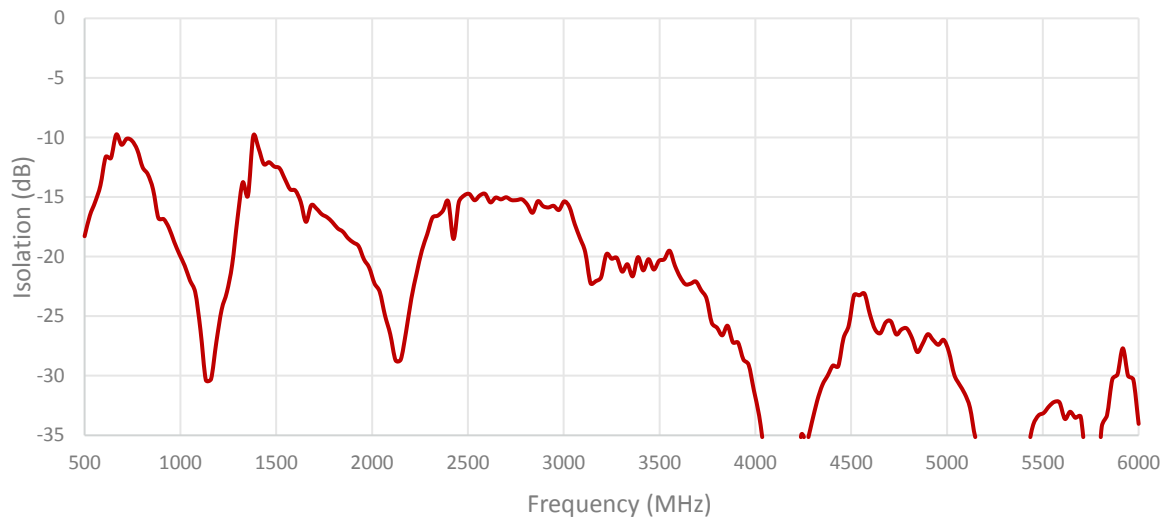

ENVELOPE CORRELATION COEFFICIENT FOR CABLES 1 AND 2

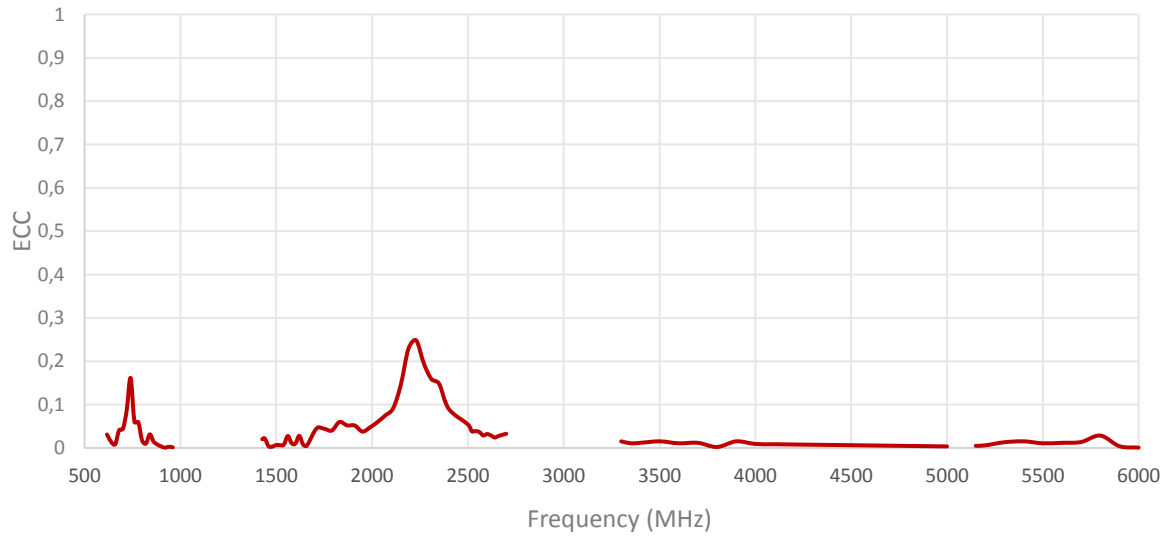

ENVELOPE CORRELATION COEFFICIENT FOR CABLES 1 AND 3

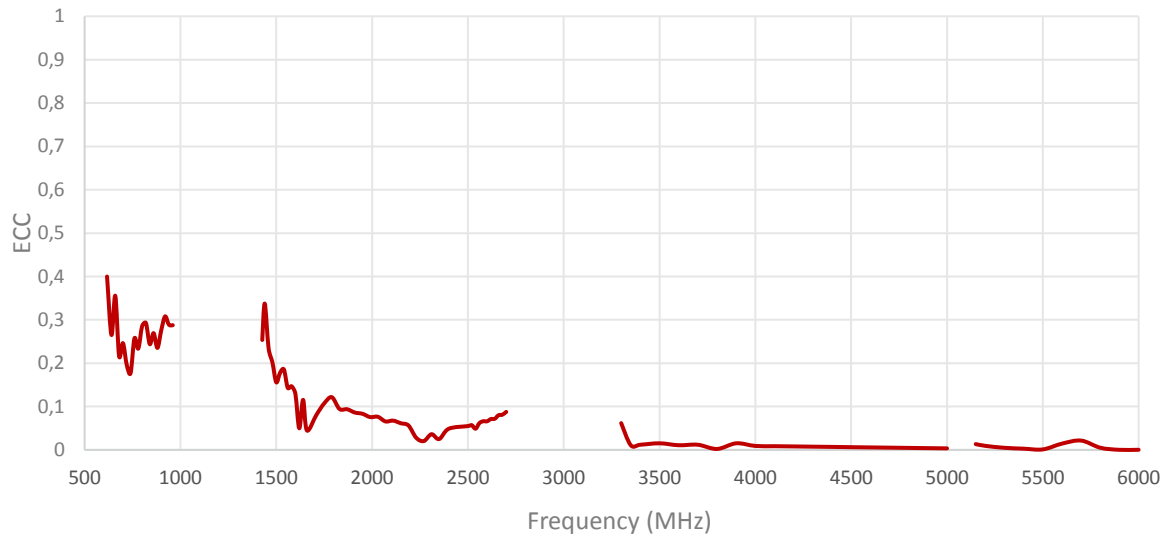

ENVELOPE CORRELATION COEFFICIENT FOR CABLES 1 AND 4

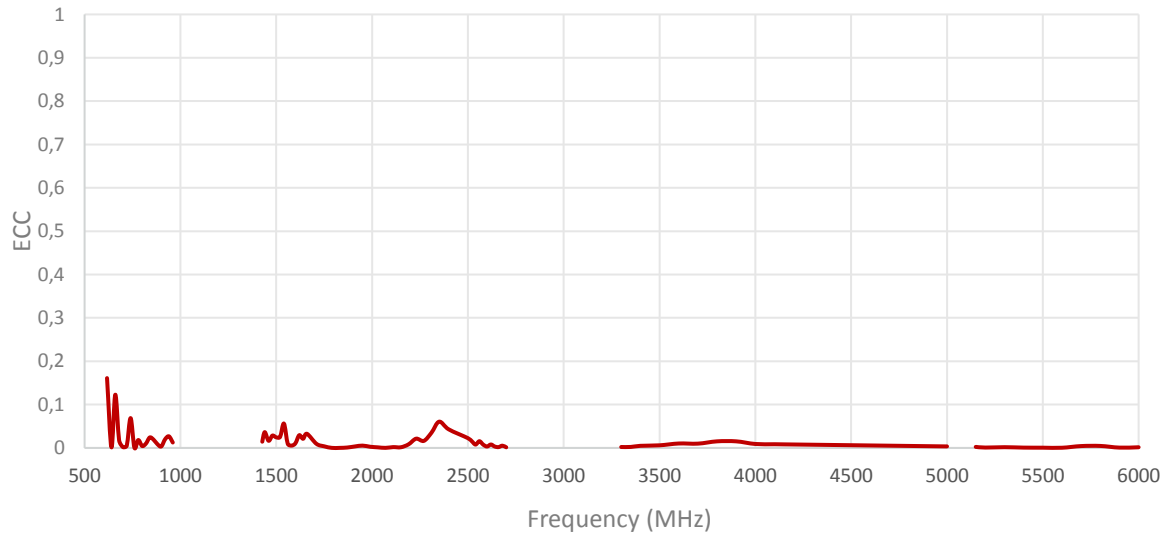

ENVELOPE CORRELATION COEFFICIENT FOR CABLES 2 AND 3

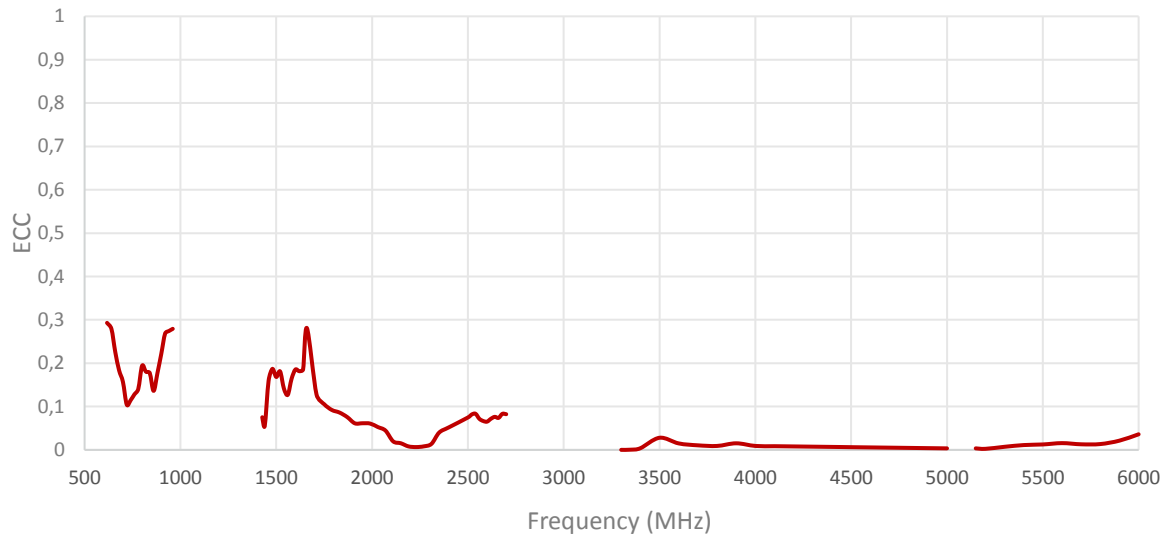

ENVELOPE CORRELATION COEFFICIENT FOR CABLES 2 AND 4

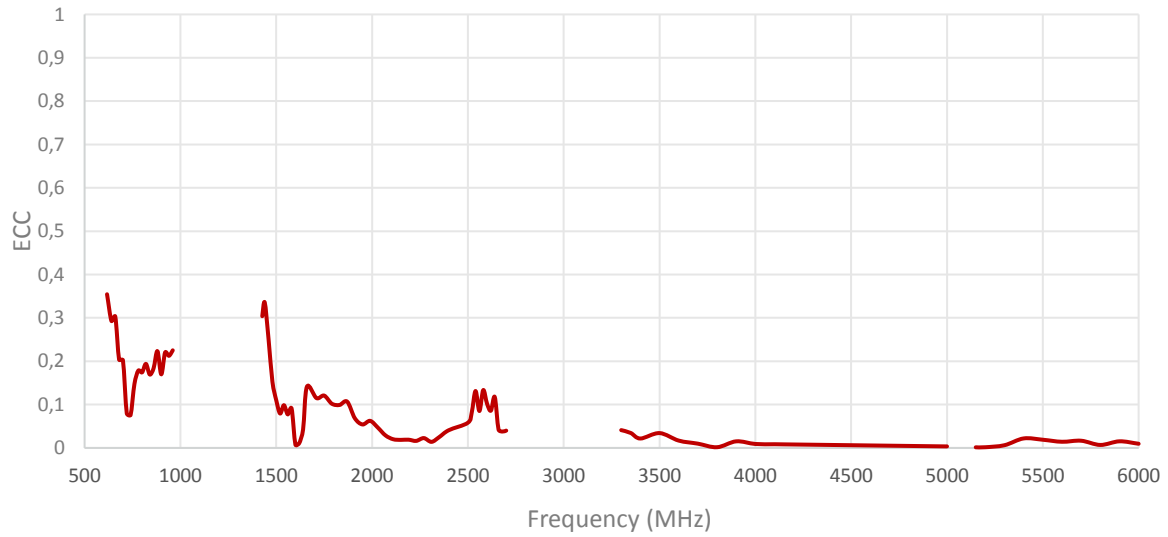

ENVELOPE CORRELATION COEFFICIENT FOR CABLES 3 AND 4

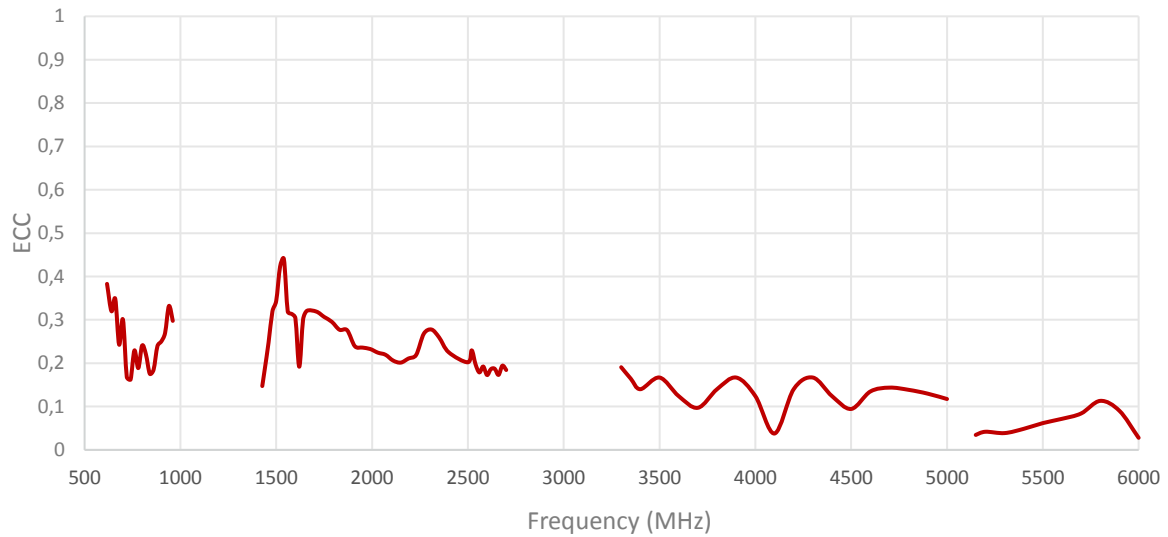



Radiation pattern reference

Cable 1: 5GNR

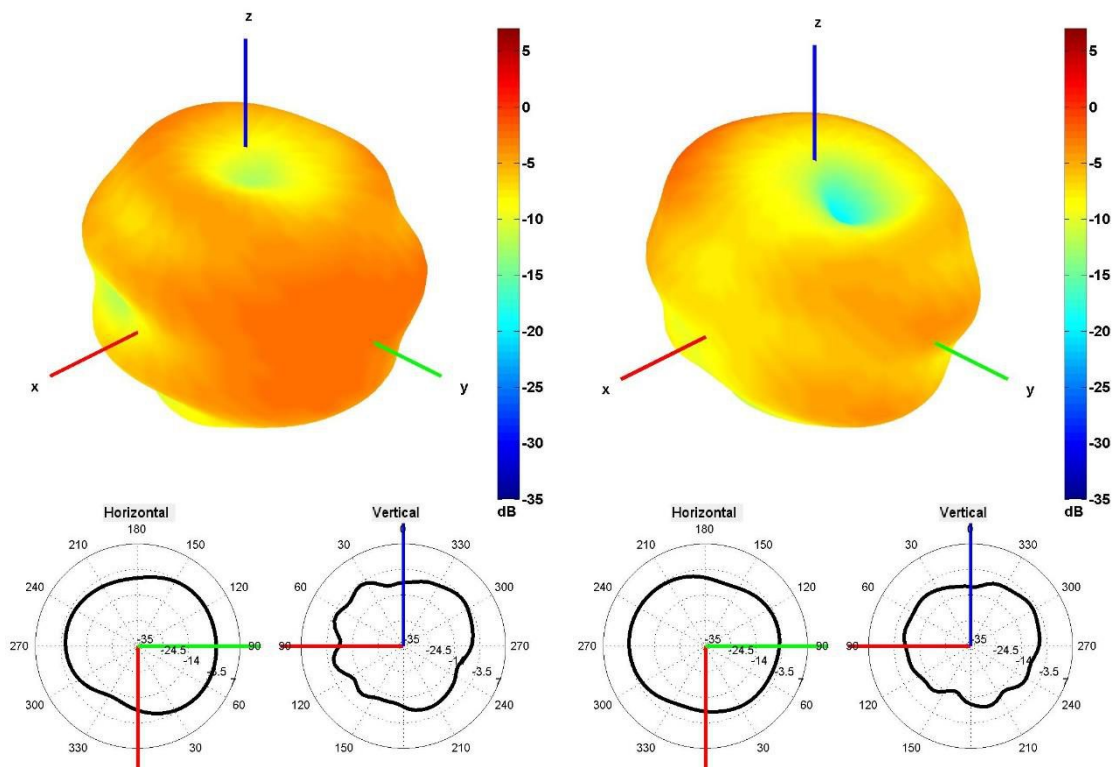

650 and 750 MHz Radiation pattern

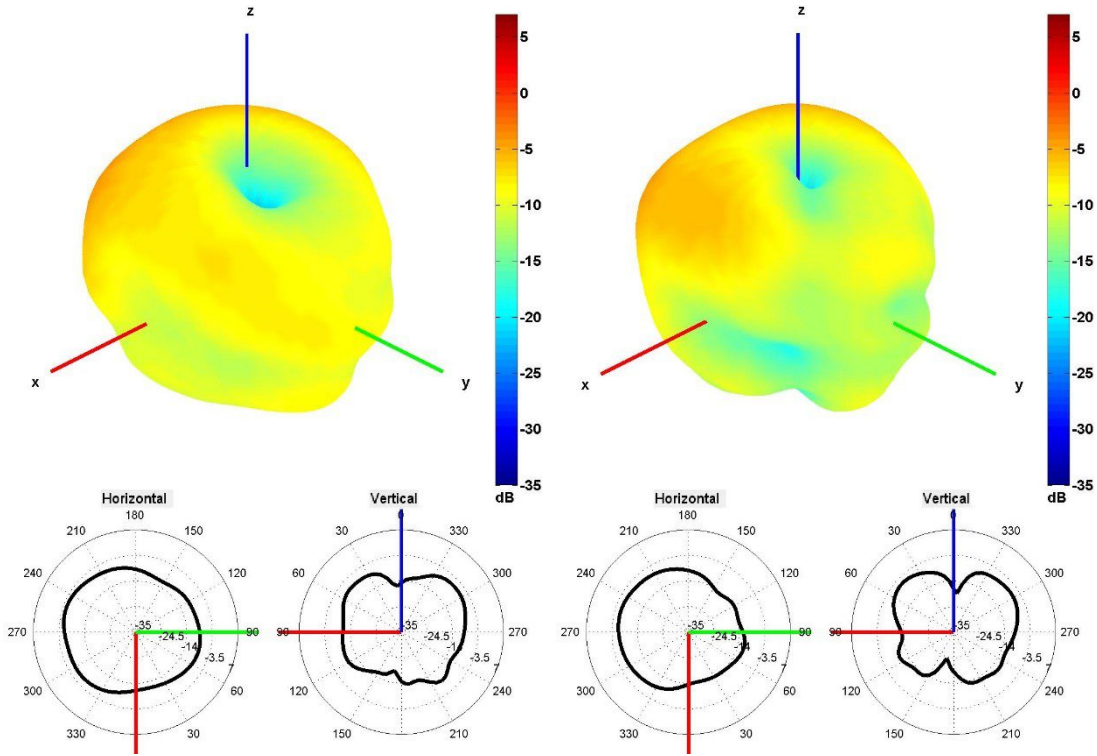

850 and 940 MHz Radiation pattern

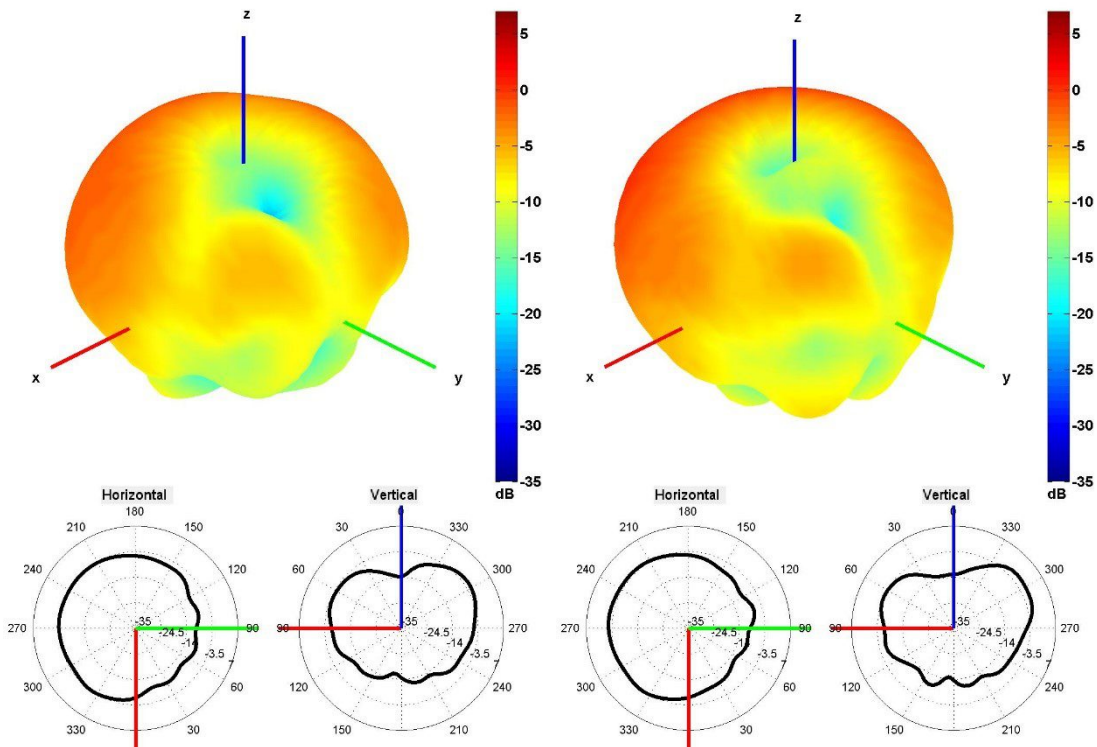

1500 and 1600 MHz Radiation pattern

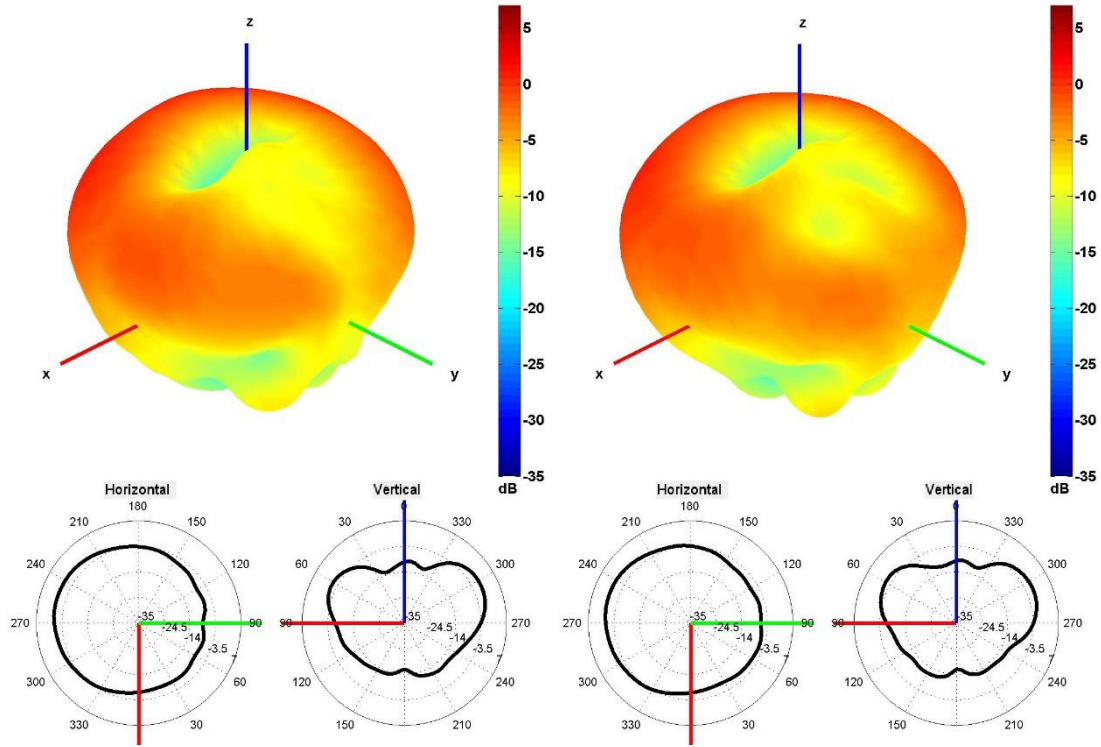

1750 and 1850 MHz Radiation pattern

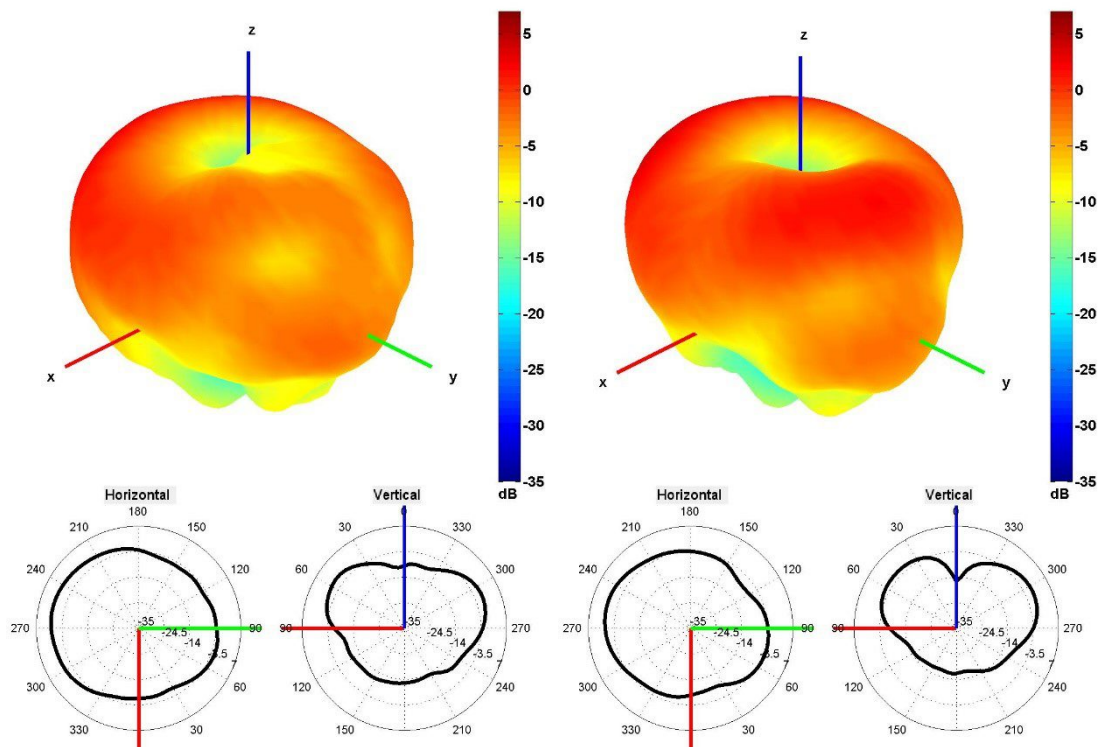

1950 and 2100 MHz Radiation pattern

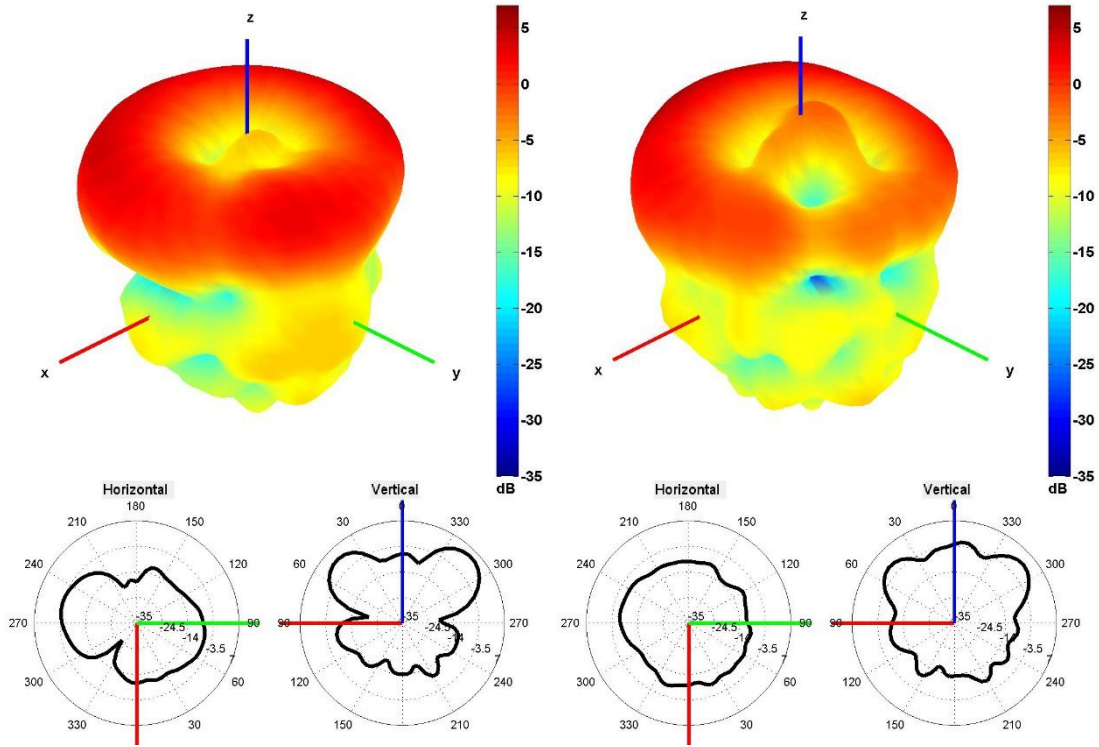

2350 and 2600 MHz Radiation pattern

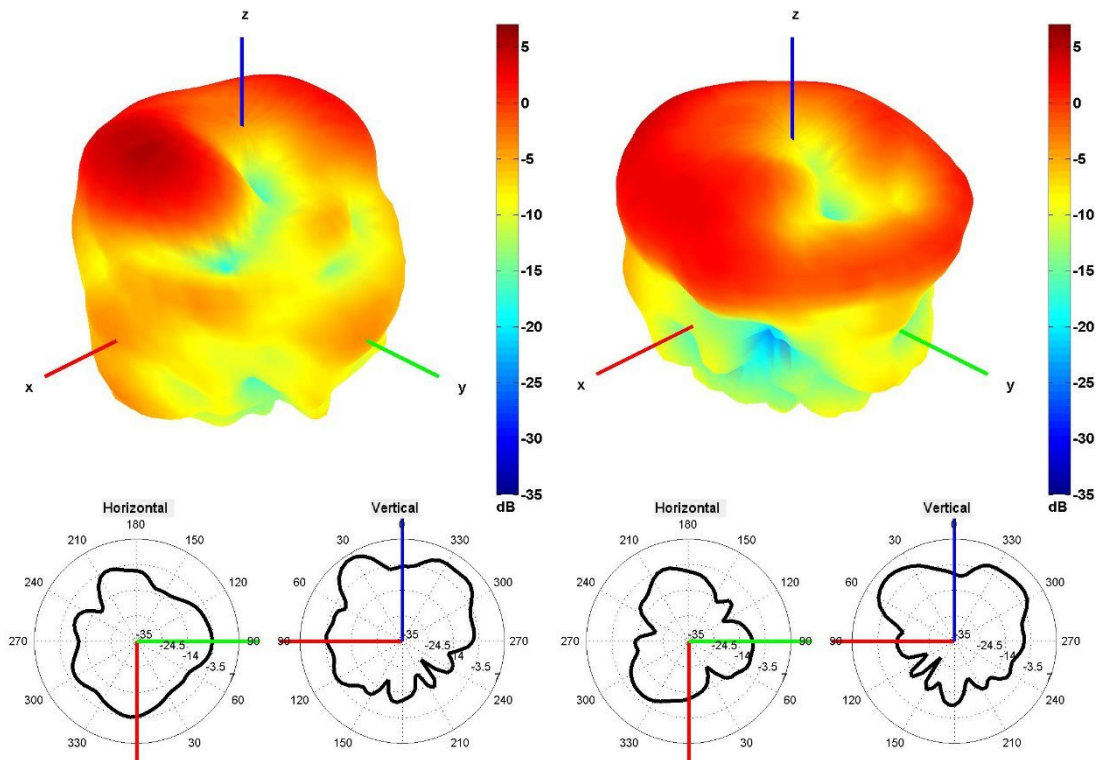

3350 and 3600 MHz Radiation pattern

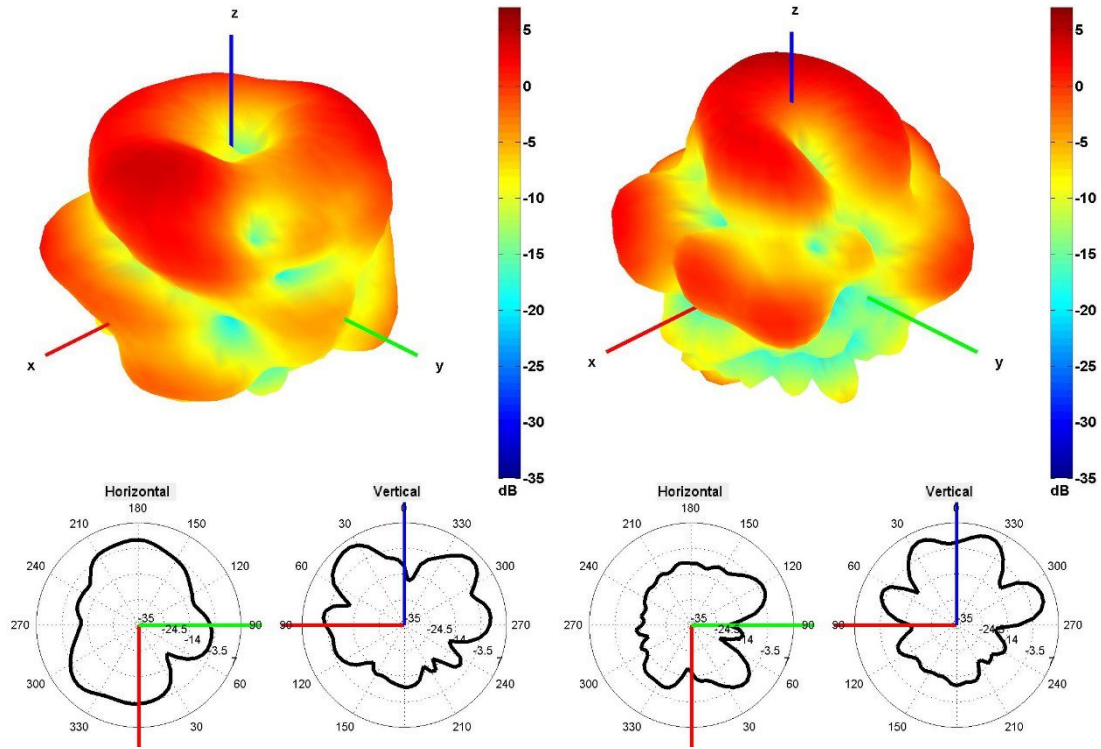

4500 and 5500 MHz Radiation pattern

Cable 2: 5GNR

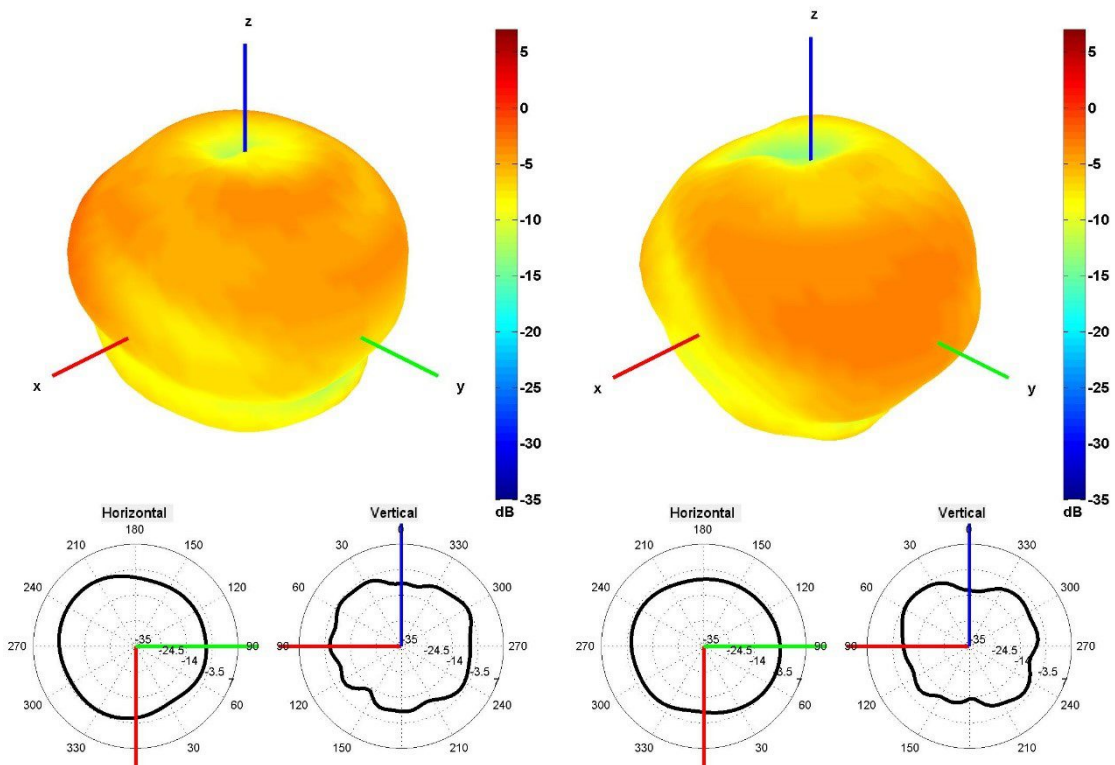

650 and 750 MHz Radiation pattern

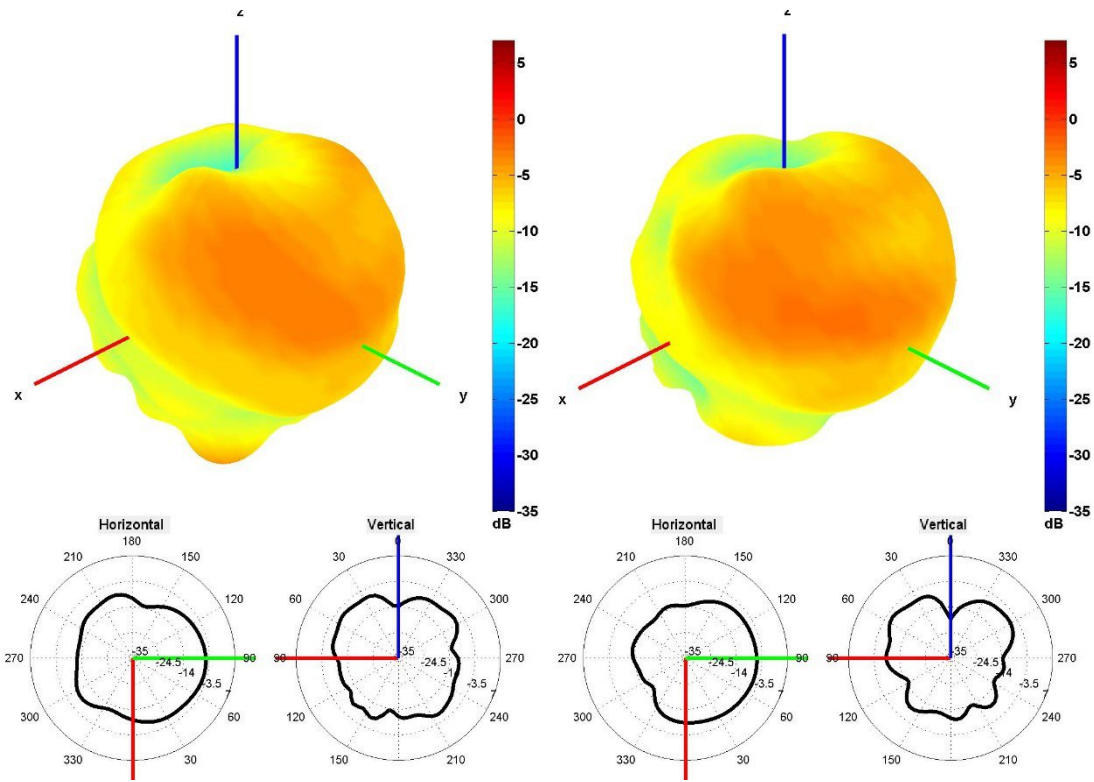

850 and 940 MHz Radiation pattern

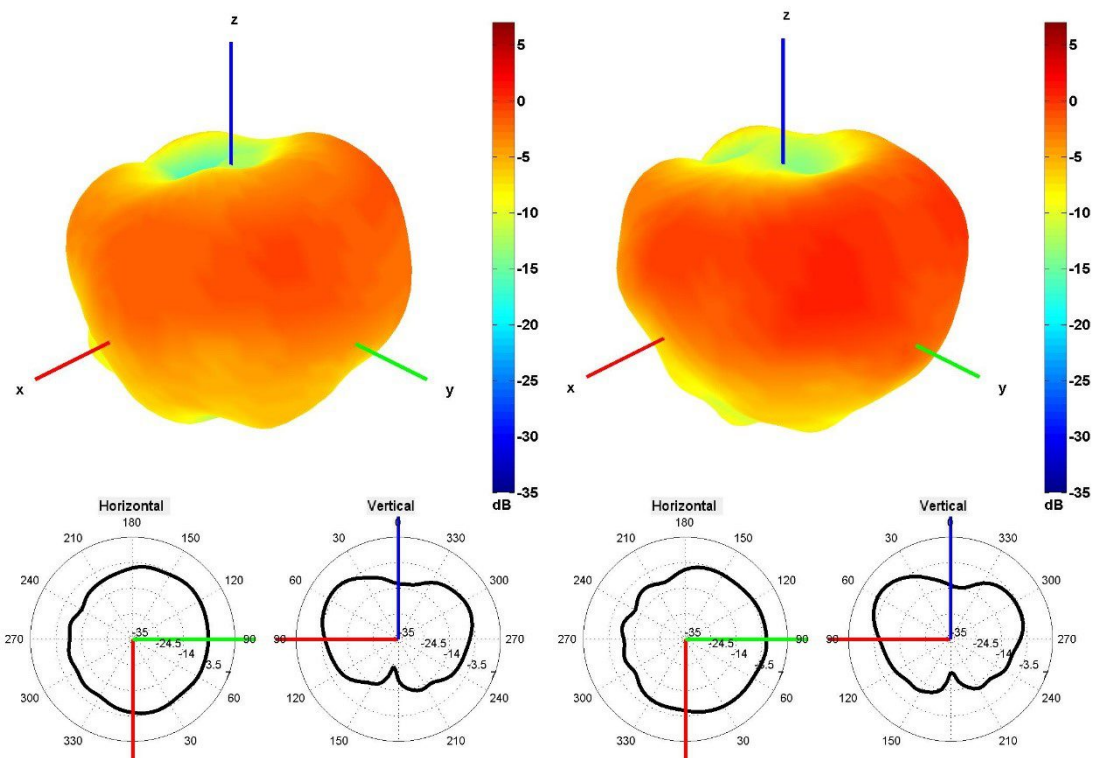

1500 and 1600 MHz Radiation pattern

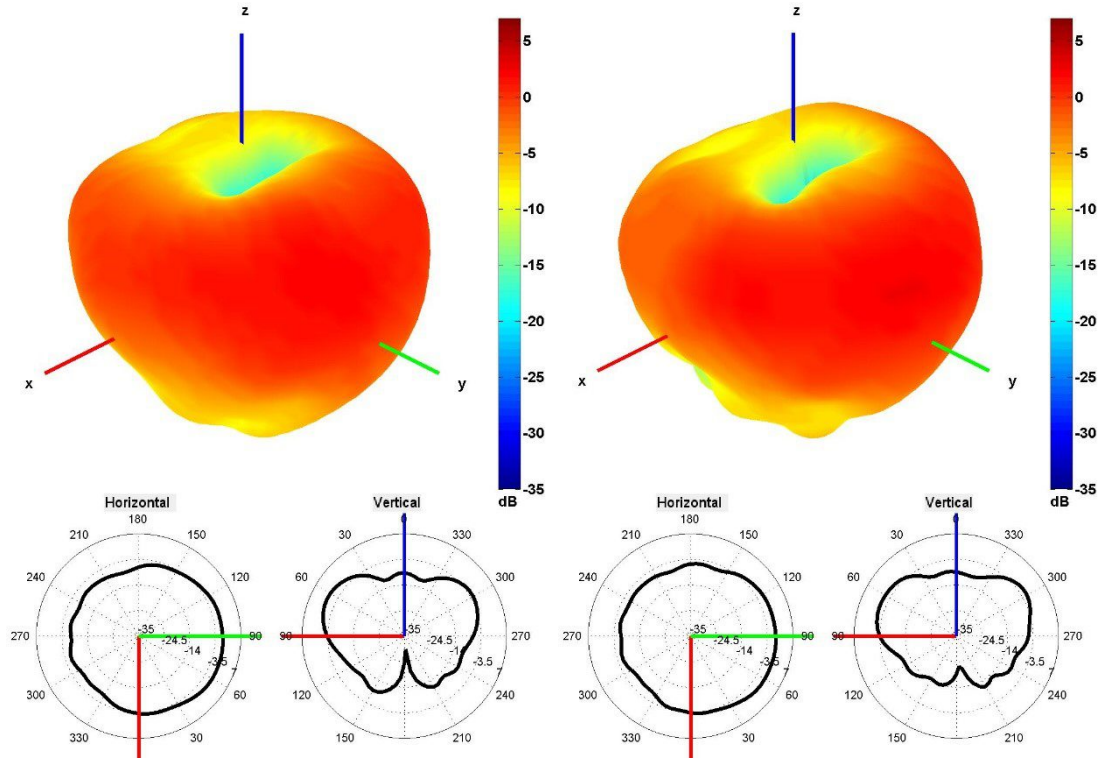

1750 and 1850 MHz Radiation pattern

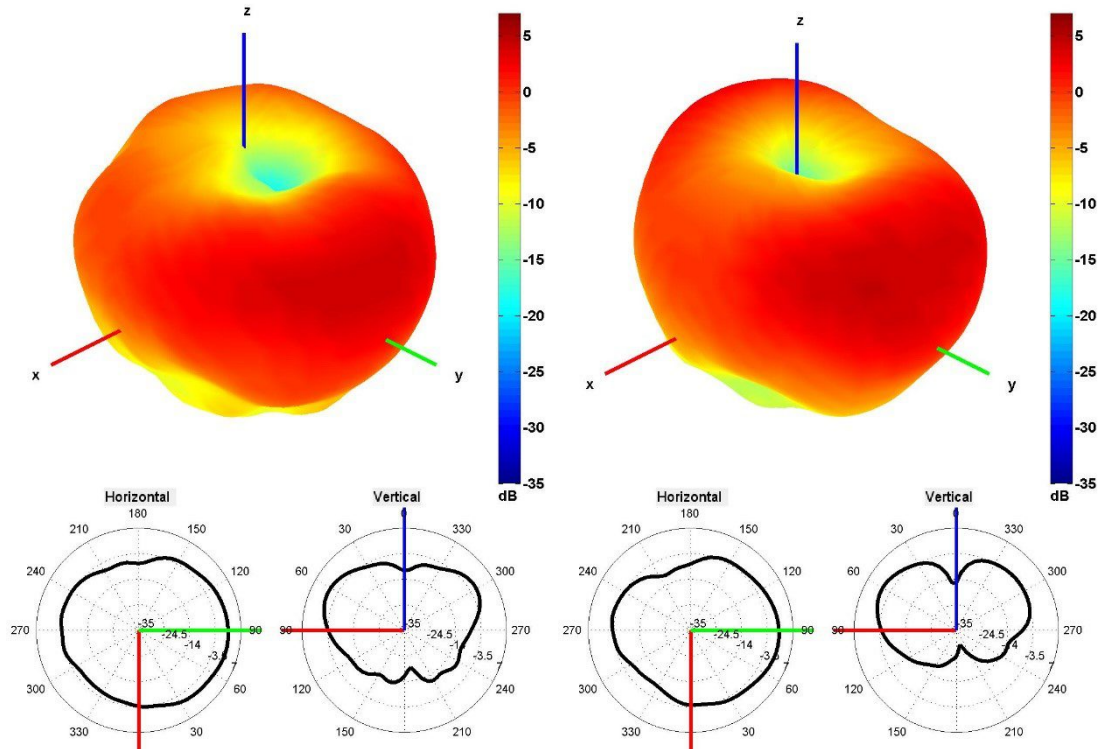

1950 and 2100 MHz Radiation pattern

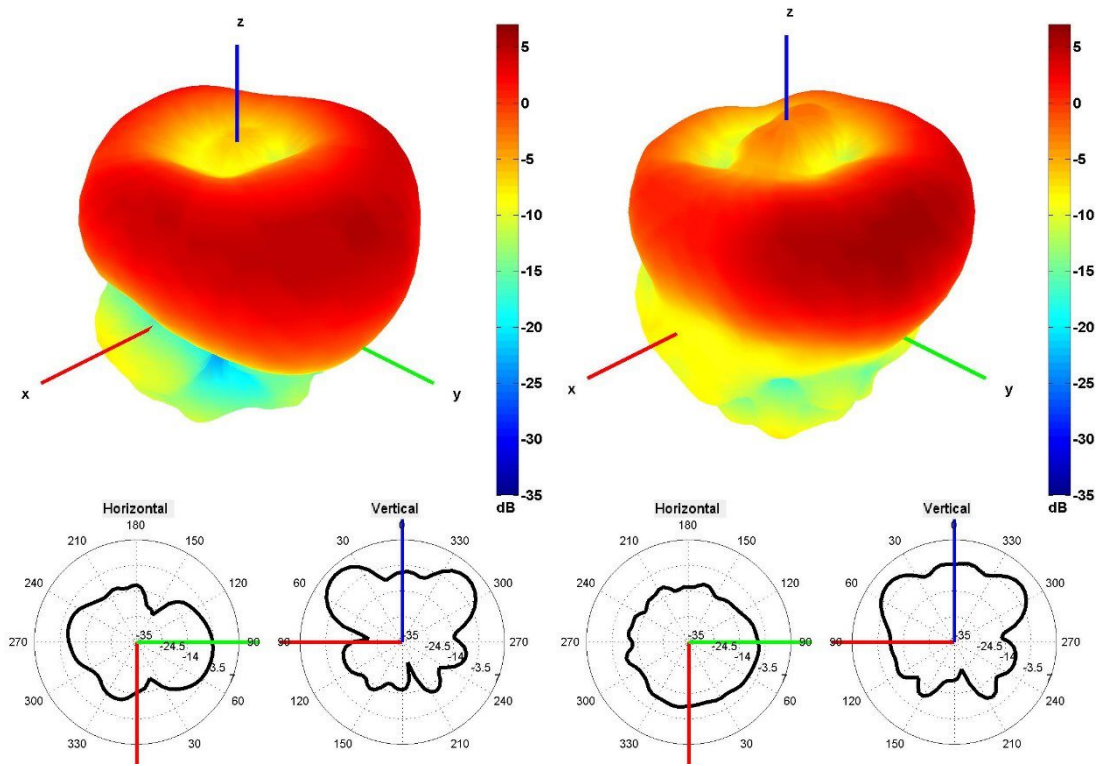

2350 and 2600 MHz Radiation pattern

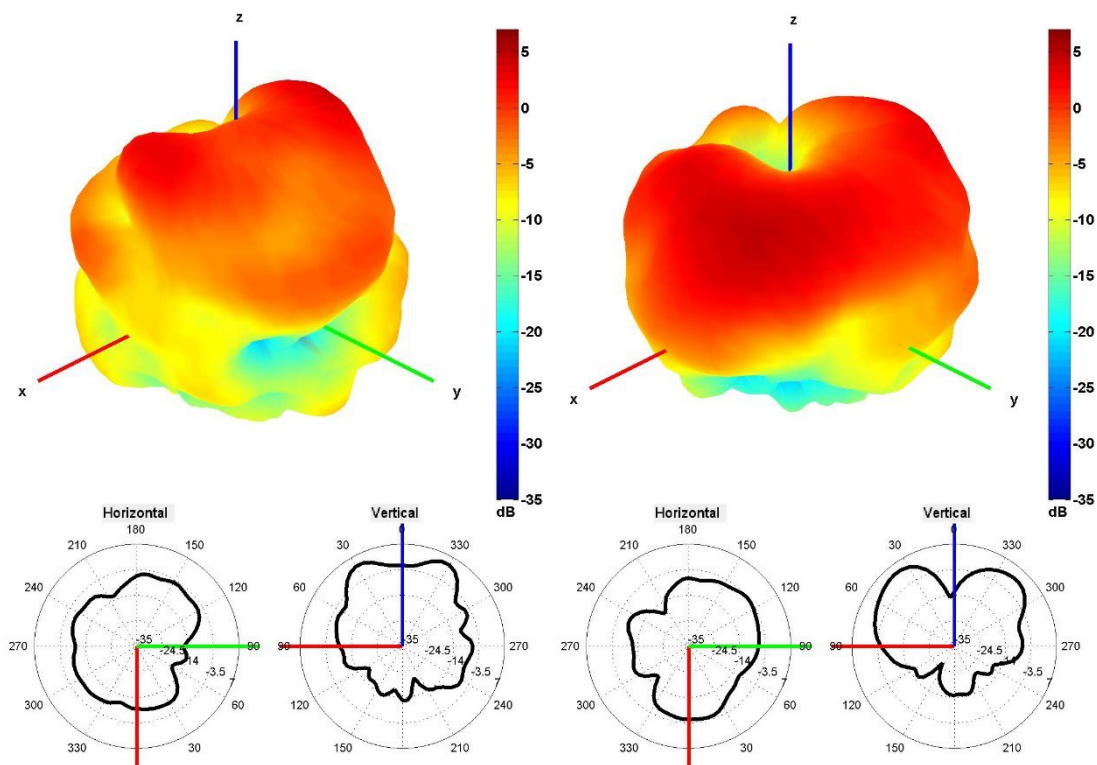

3350 and 3600 MHz Radiation pattern

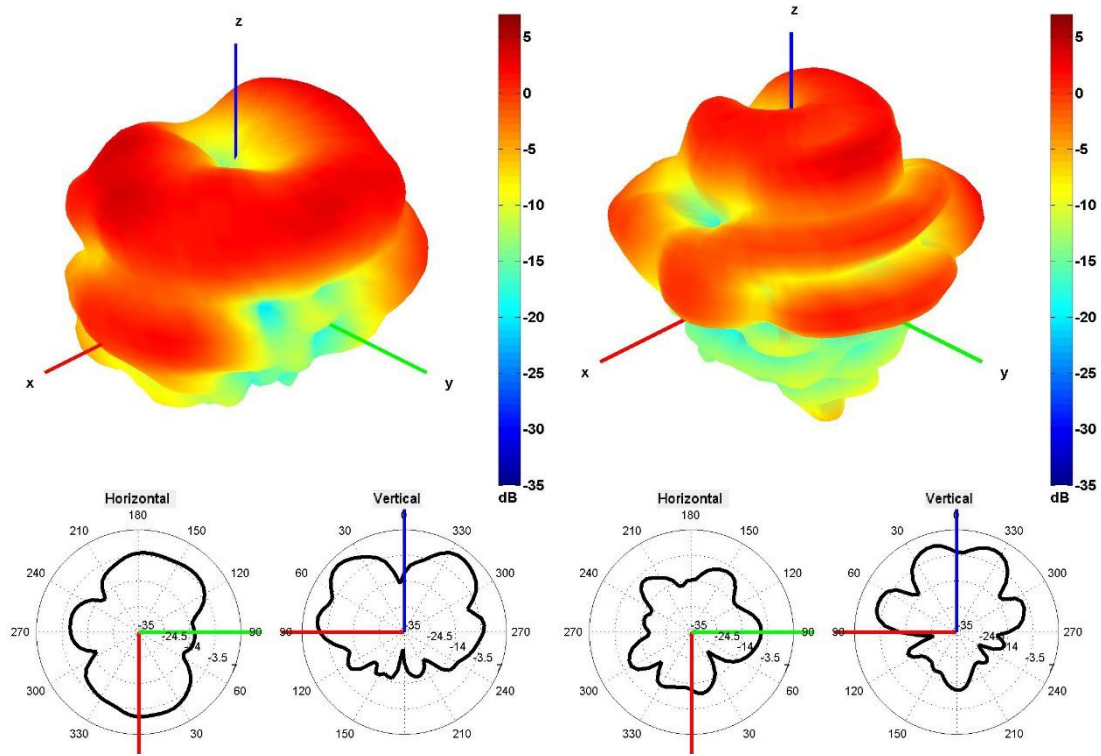

4500 and 5500 MHz Radiation pattern

Cable 3: 5GNR

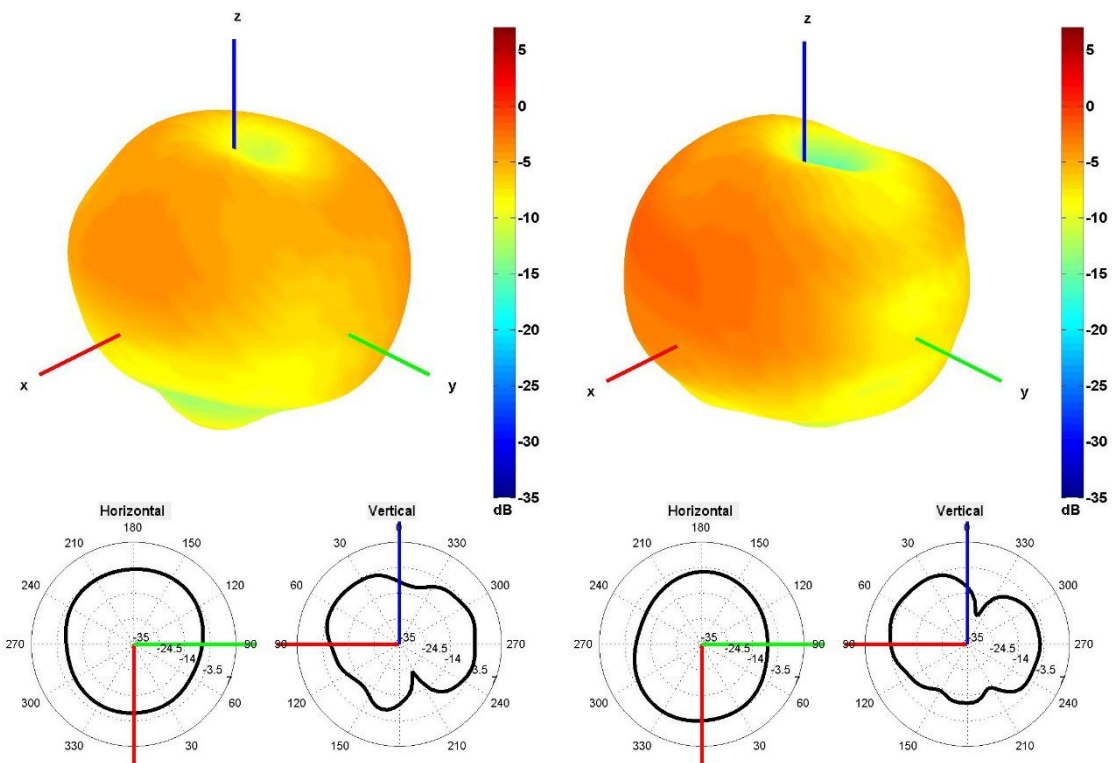

650 and 750 MHz Radiation pattern

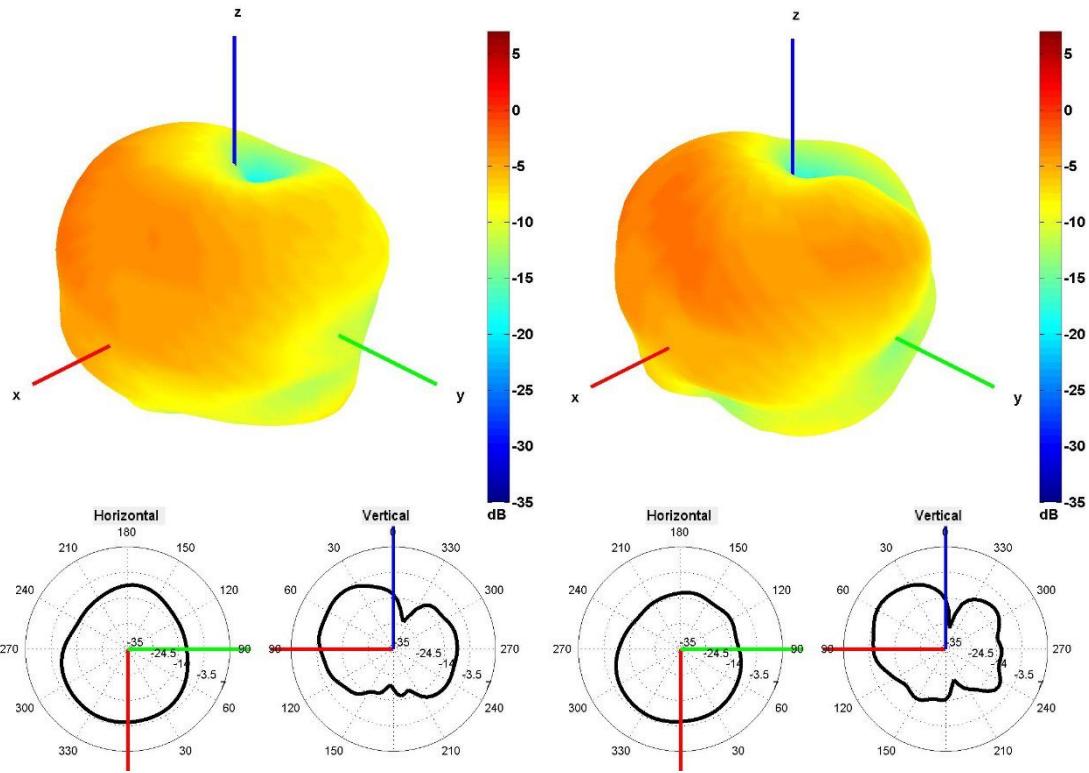

850 and 940 MHz Radiation pattern

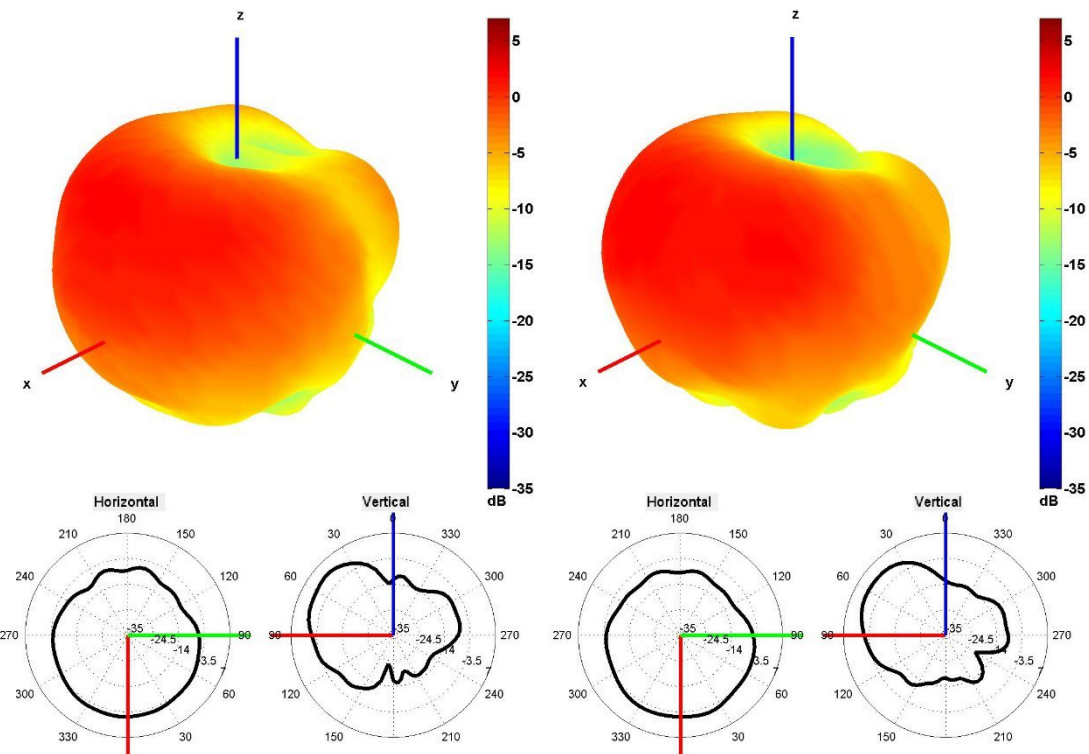

1500 and 1600 MHz Radiation pattern

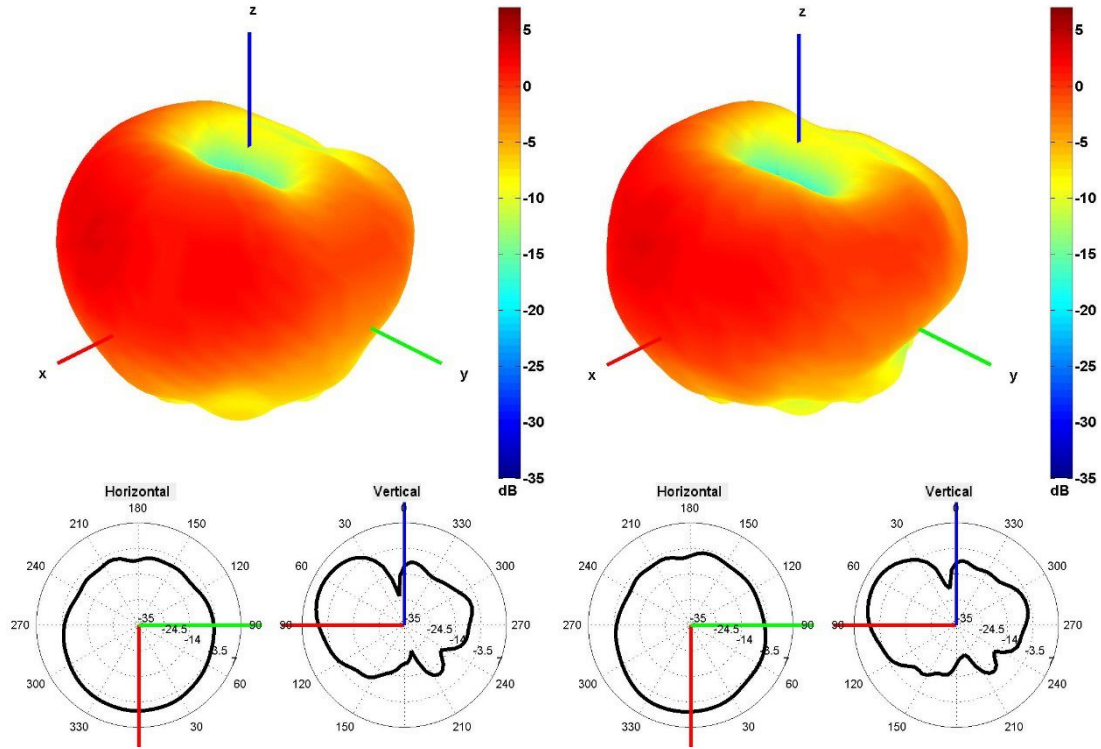

1750 and 1850 MHz Radiation pattern

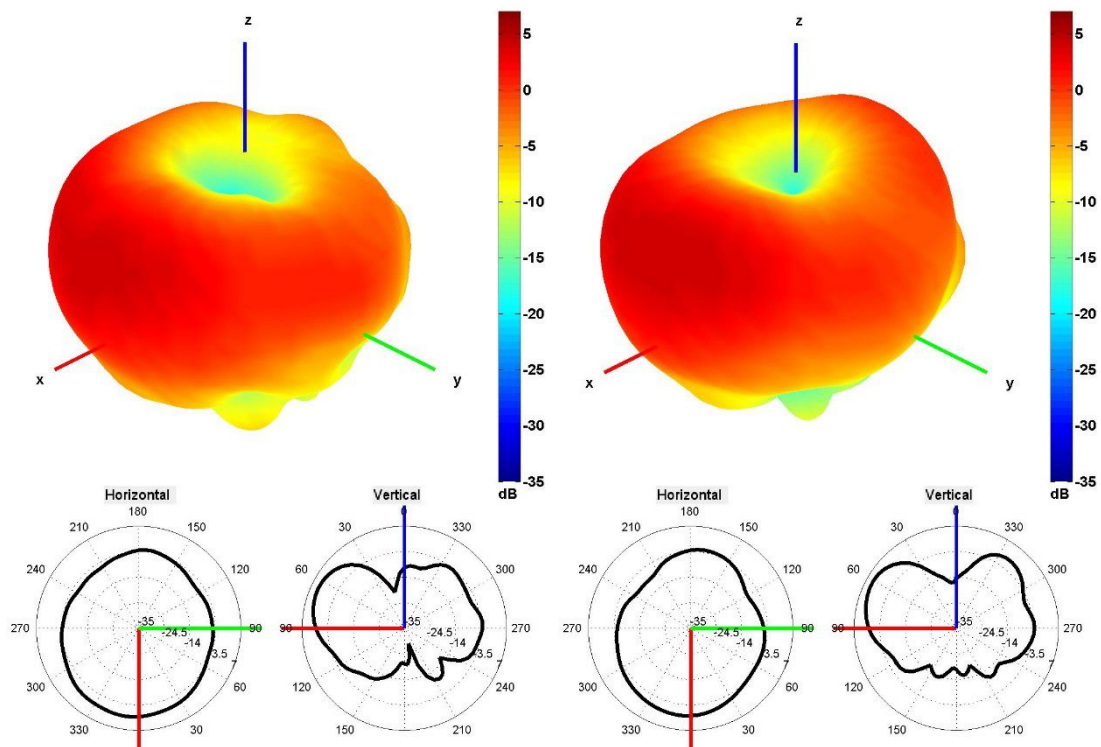

1950 and 2100 MHz Radiation pattern

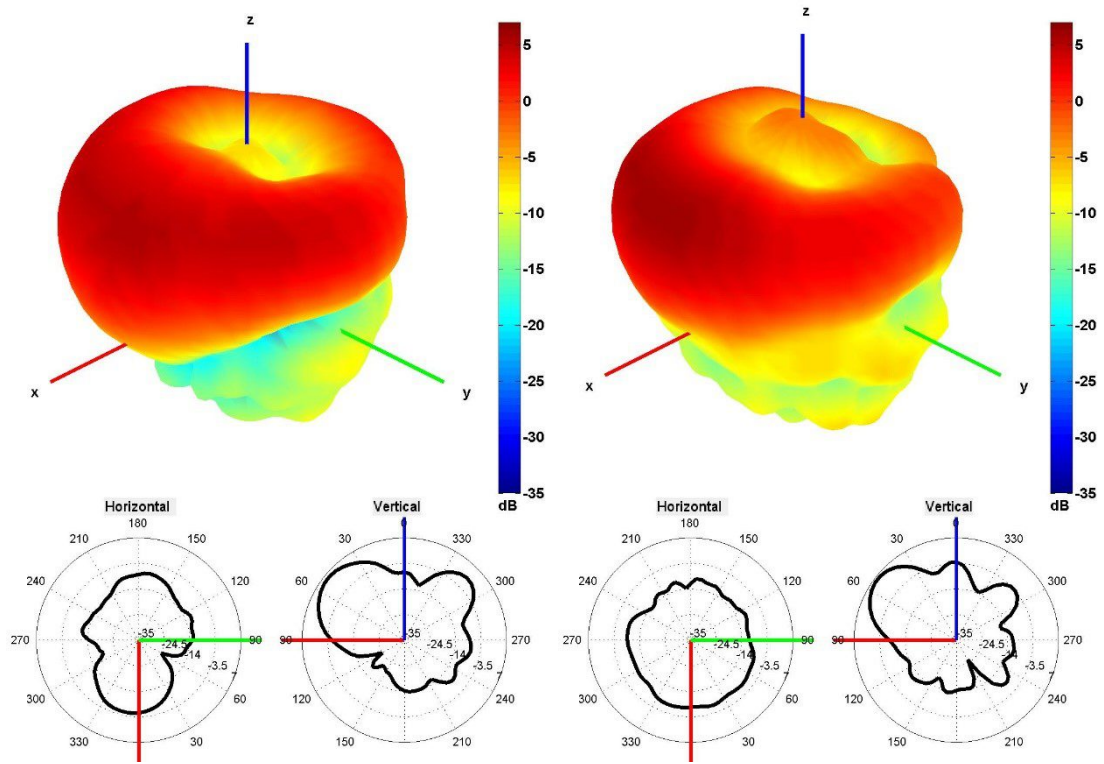

2350 and 2600 MHz Radiation pattern

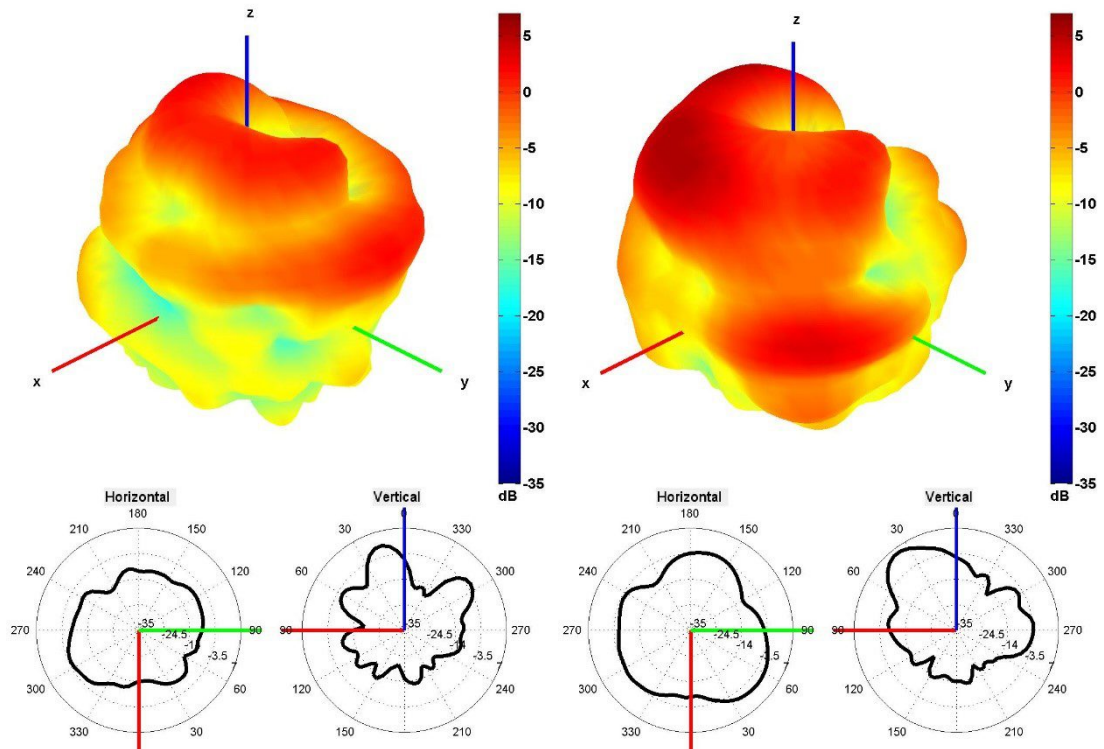

3350 and 3600 MHz Radiation pattern

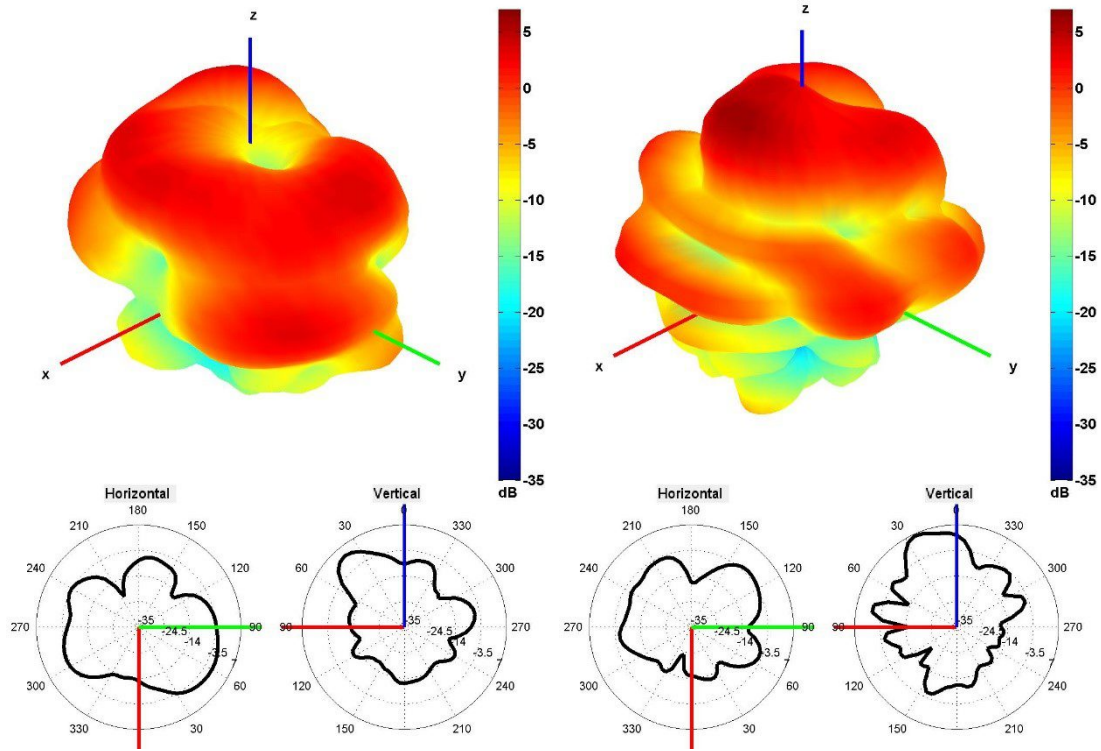

4500 and 5500 MHz Radiation pattern

Table 4: 5GNR

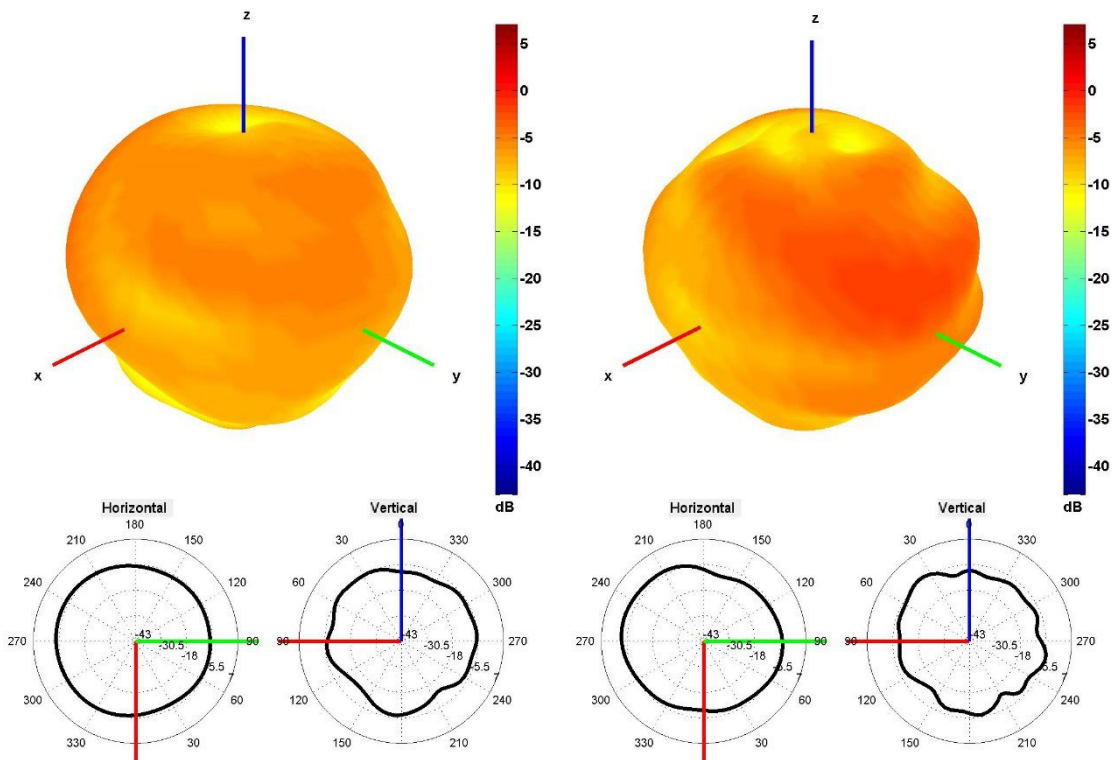

650 and 750 MHz Radiation pattern

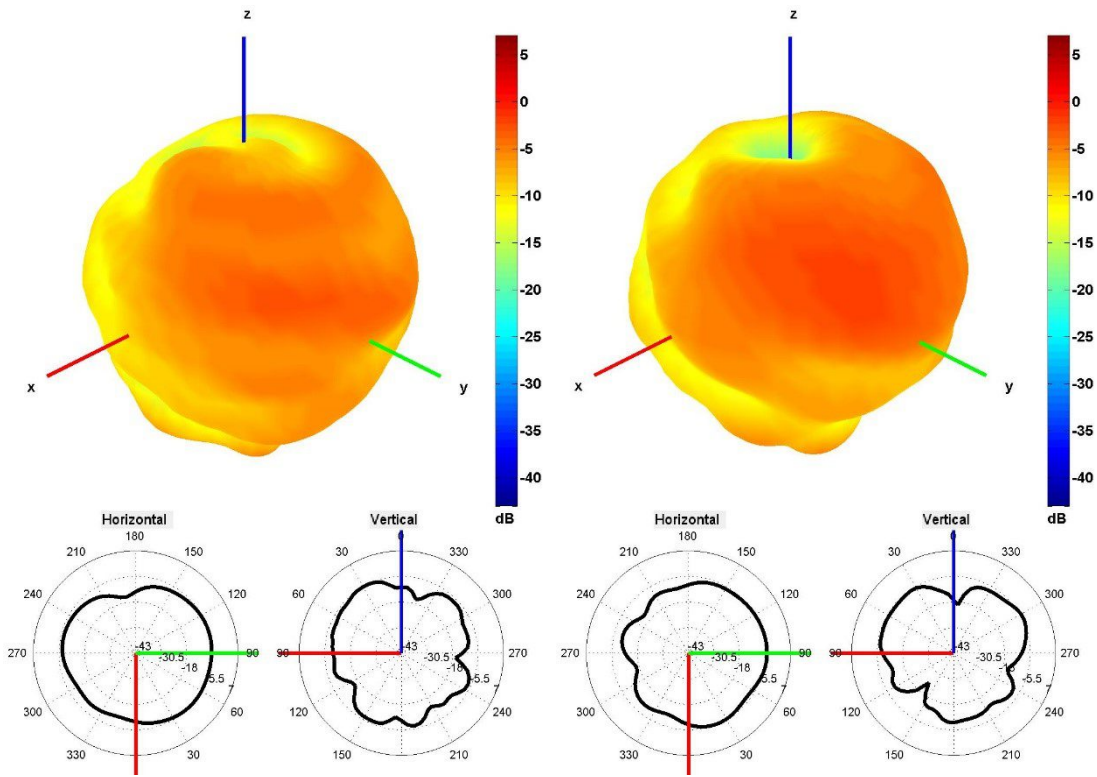

850 and 940 MHz Radiation pattern

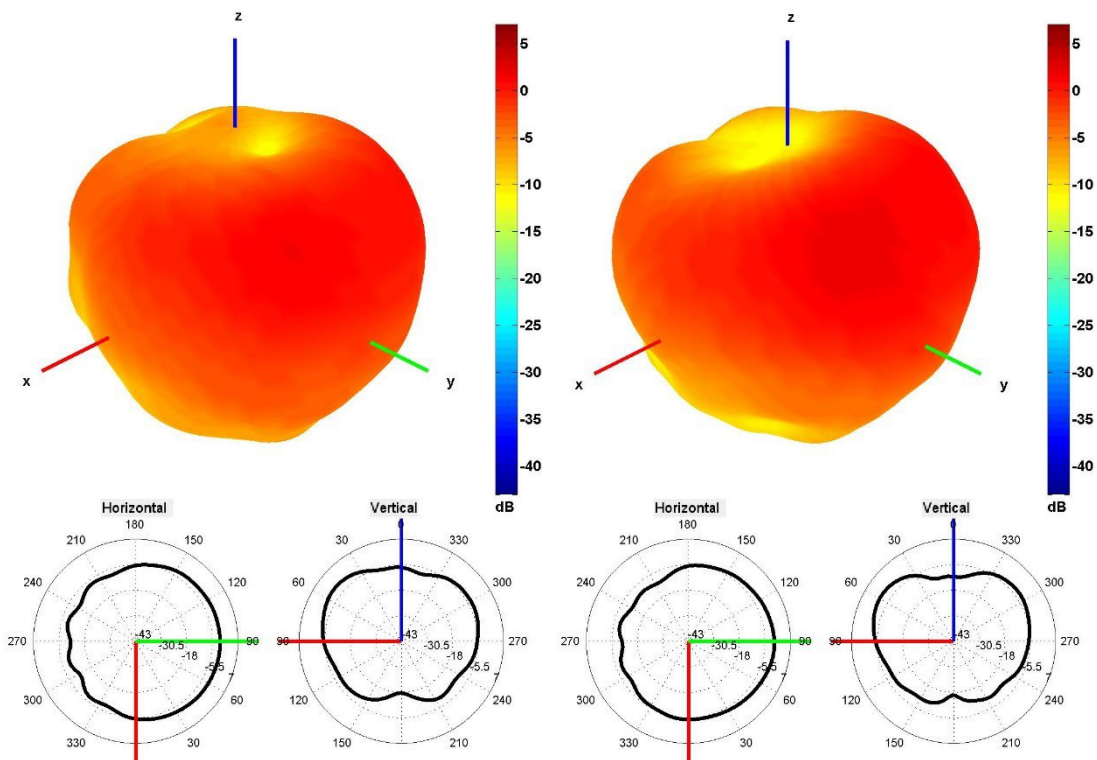

1500 and 1600 MHz Radiation pattern

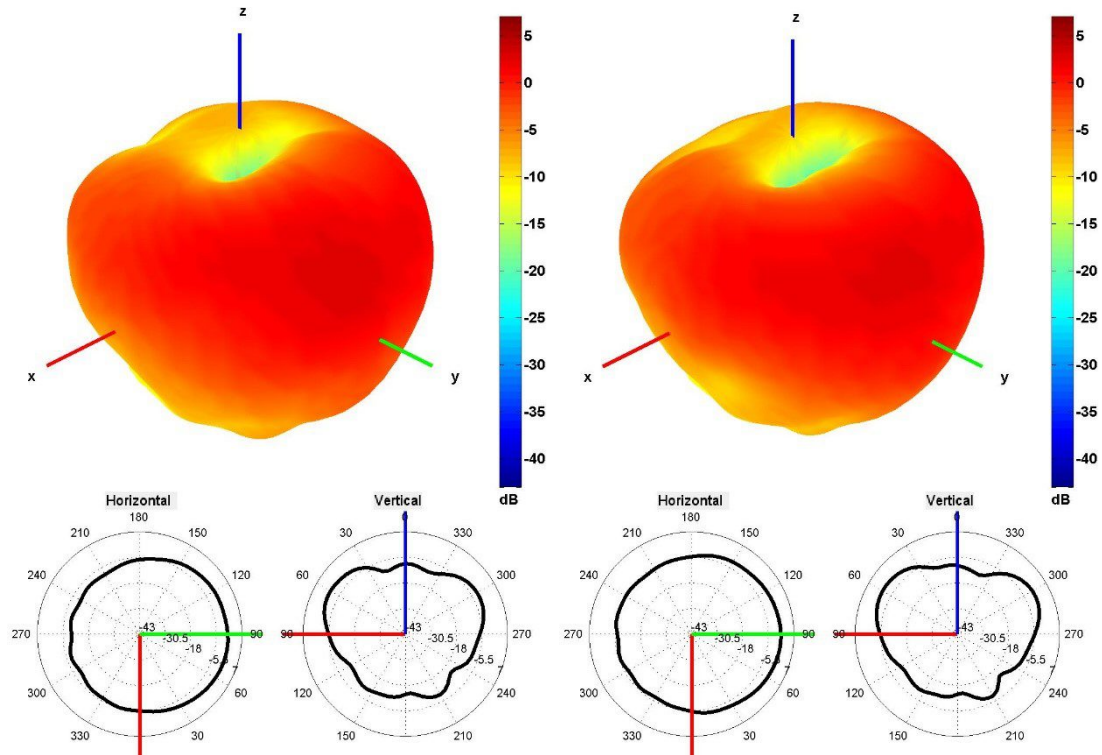

1750 and 1850 MHz Radiation pattern

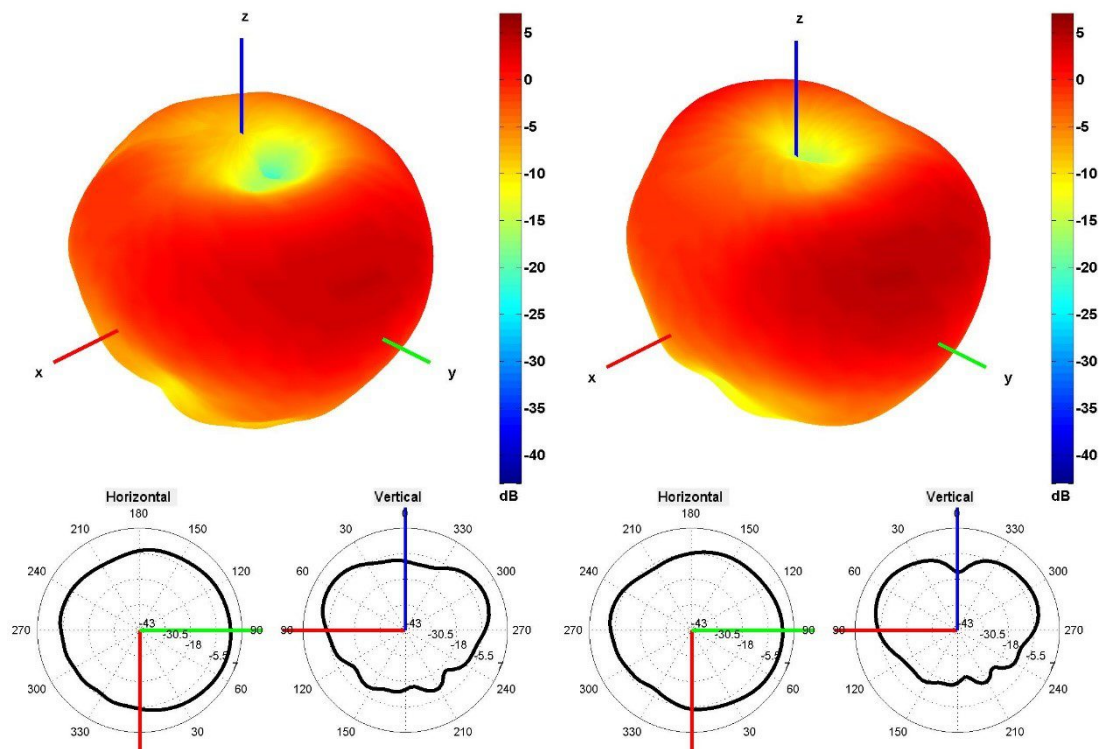

1950 and 2100 MHz Radiation pattern

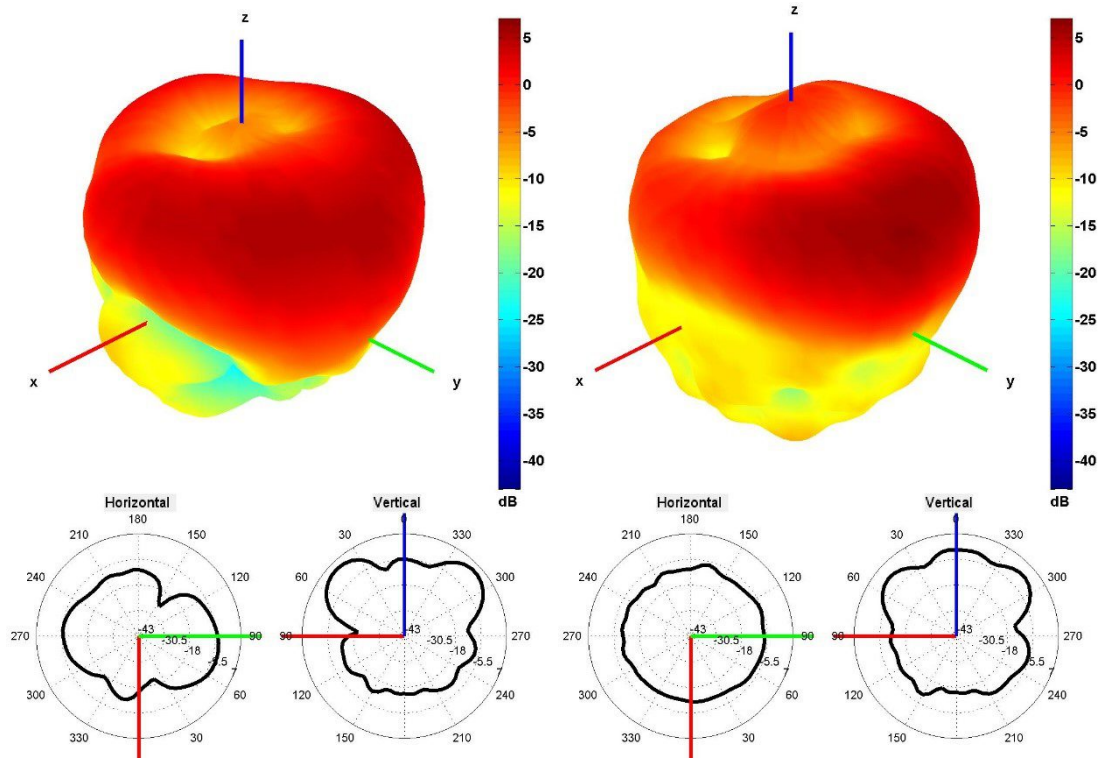

2350 and 2600 MHz Radiation pattern

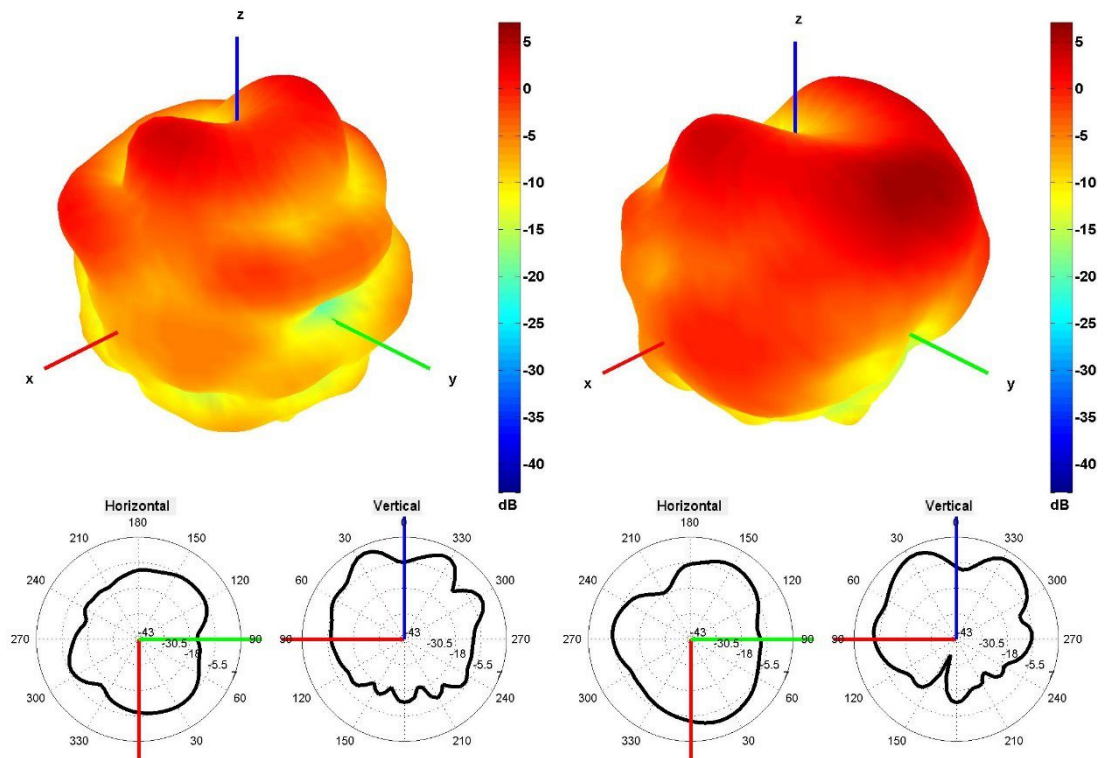

3350 and 3600 MHz Radiation pattern

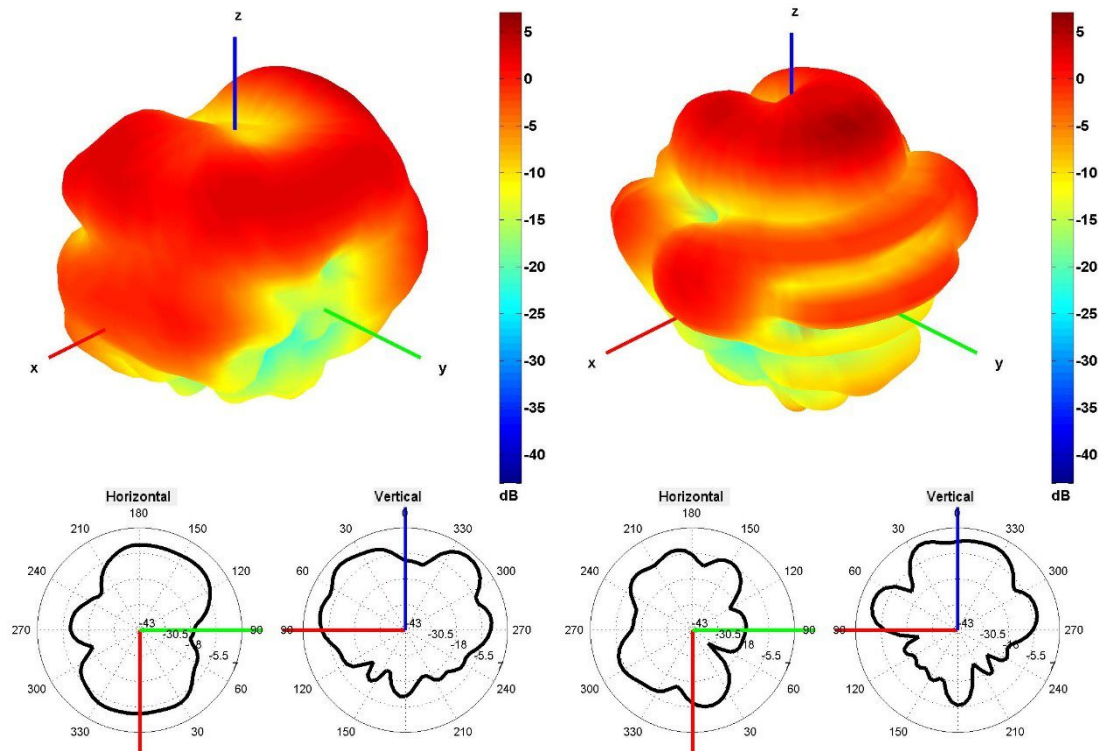

4500 and 5500 MHz Radiation pattern

4. Antenna drawings

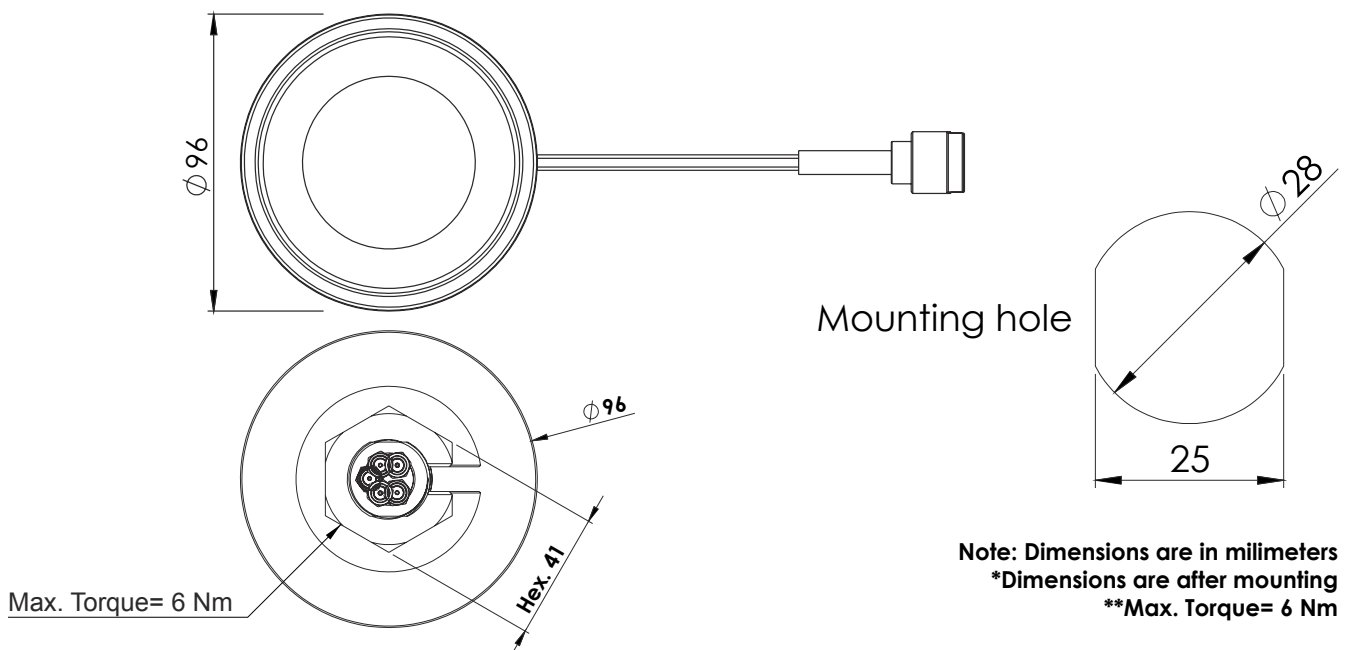
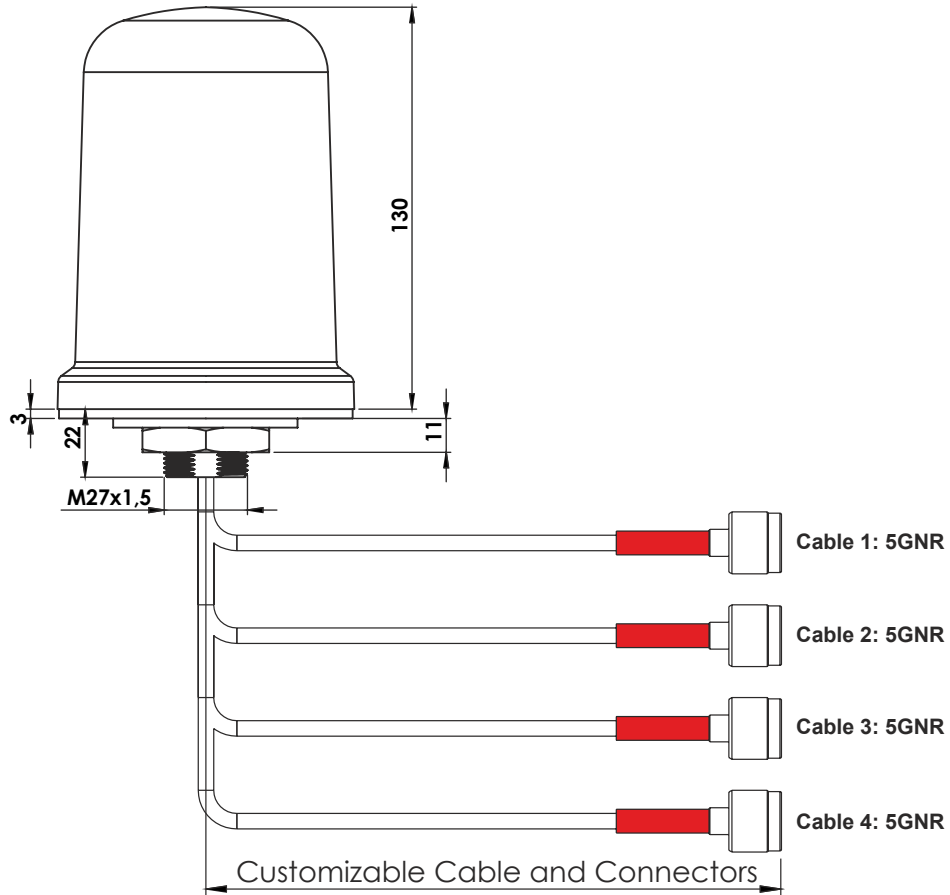

5. Antenna Images

