

2J7615B-915

915 MHz ISM Screw Mount

Key Features

915 MHz ISM

- 902-928 MHz

Screw Mount

Anti-Rotation Mechanism

Ground Plane Independent

Customizable Cable and Connector

Dimensions: Ø 50 x 50.8 mm

Certificates: IP67, IP69



1. Antenna and electrical specifications

Parameters	915 MHz ISM Antenna
Standards	ZigBee, ISM, SIGFOX, LoRa
Band (MHz)	915 MHz
Frequency (MHz)	902-928
Return Loss (dB)	~-10.1
VSWR	~2.1:1
Efficiency (%)	~50.5
Peak Gain (dBi)	~2.5
Average Gain (dB)	~-3.0
Impedance (Ohm)	50
Polarisation	Linear
Radiation Pattern	Omni-Directional
Max. Input Power (W)	25
Connector Type	SMA-Male Standard (Other Connectors Available)
Cable Length	300 cm Standard (Any Cable Length Available)
Cable Type	DACAR100 Standard (Other Cables Available)

Antenna Measurement Conditions:

Mounted on 30 x 30 cm Ground Plane
 DACAR100 100 cm Cable Length
 Measured in Certified CTIA 3D Anechoic Chamber

2. Mechanical and environmental specifications

Specifications	2J7615B-915
Mounting Type	Screw Mount
Dimensions (mm)	Ø 50 x 50.8
Max. Tighten Torque (Nm)	3 Nm
Radome Type	ASA
Radome Color	Black
Antenna Base	Zamak
Gasket	Double Sided Foam
Operating Temperature (C)	-40 to +85
Storage Temperature (C)	-40 to +85
Substance Compliance	RoHS
Certificates	IP67, IP69

3. Antenna parameters

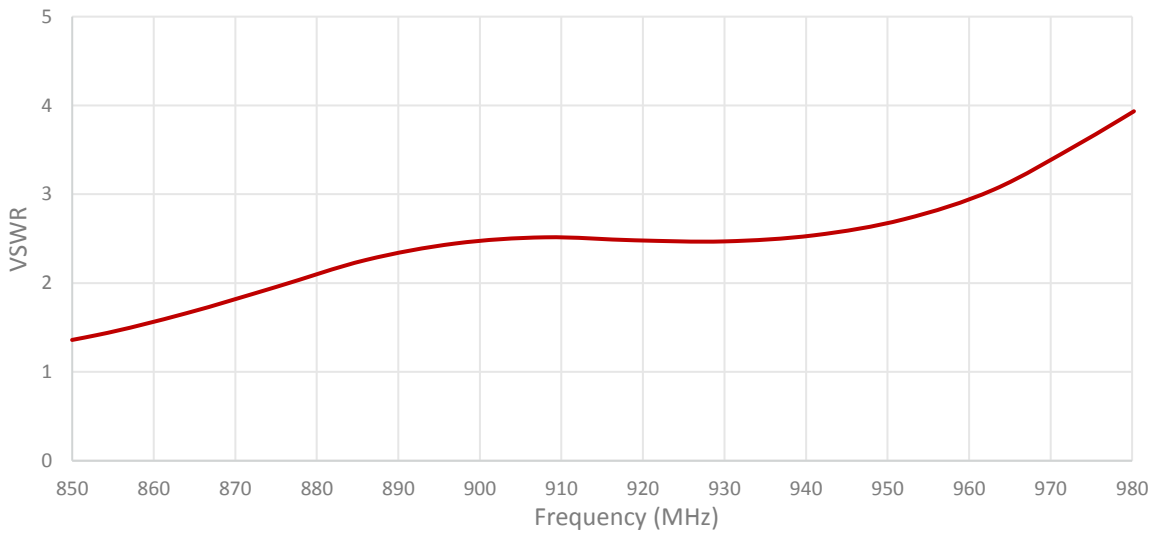
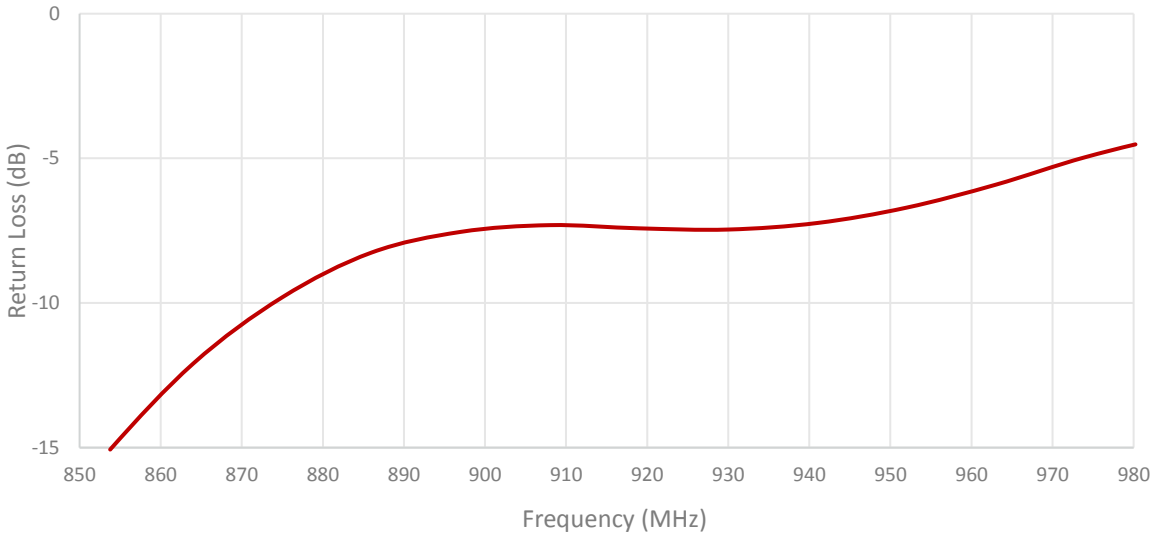

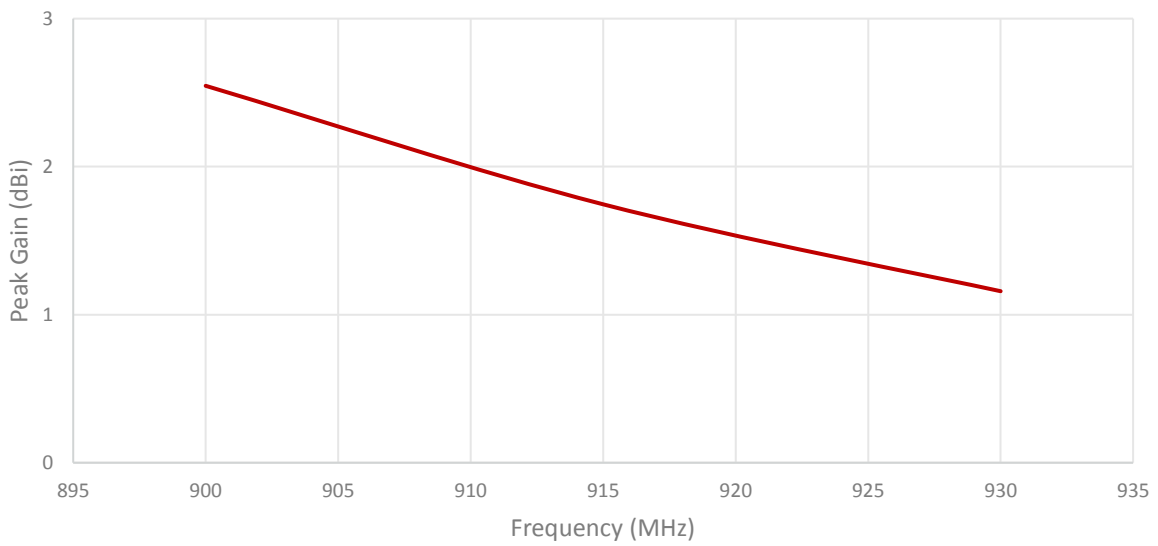
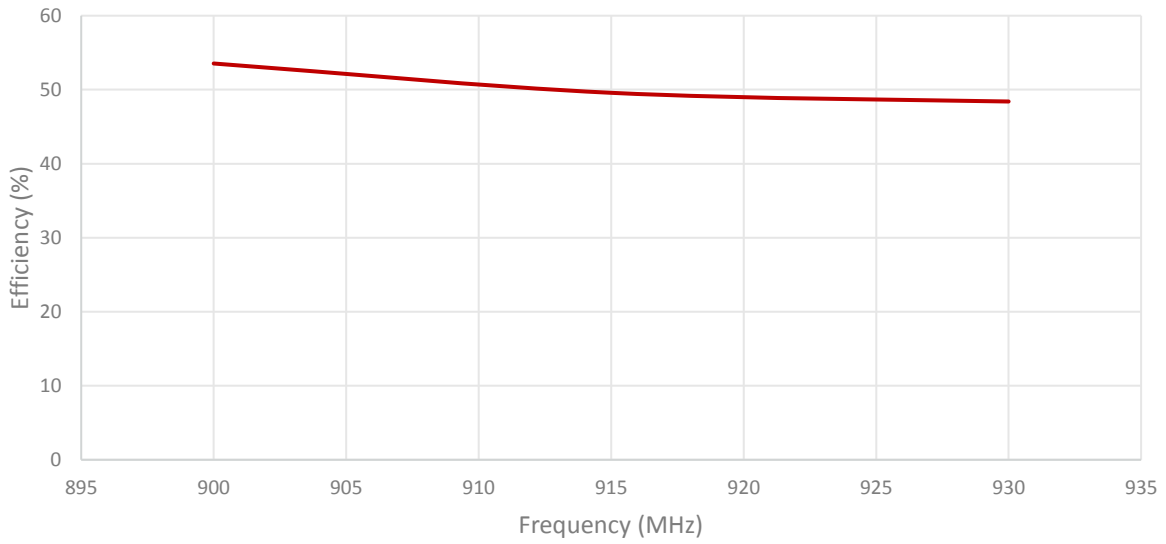

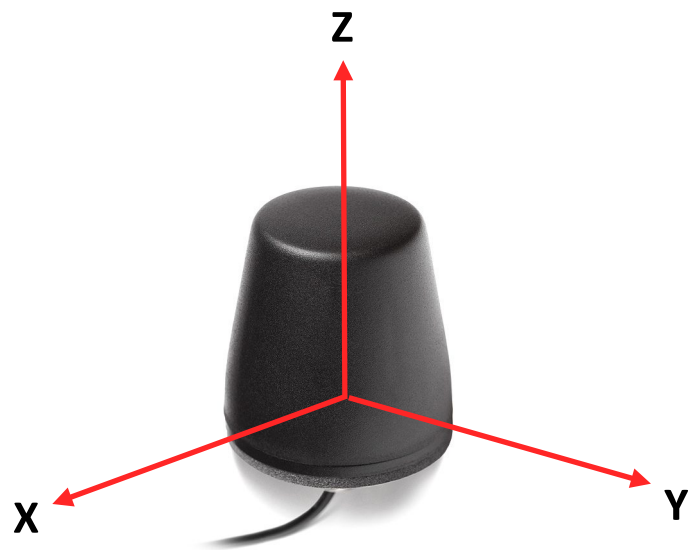
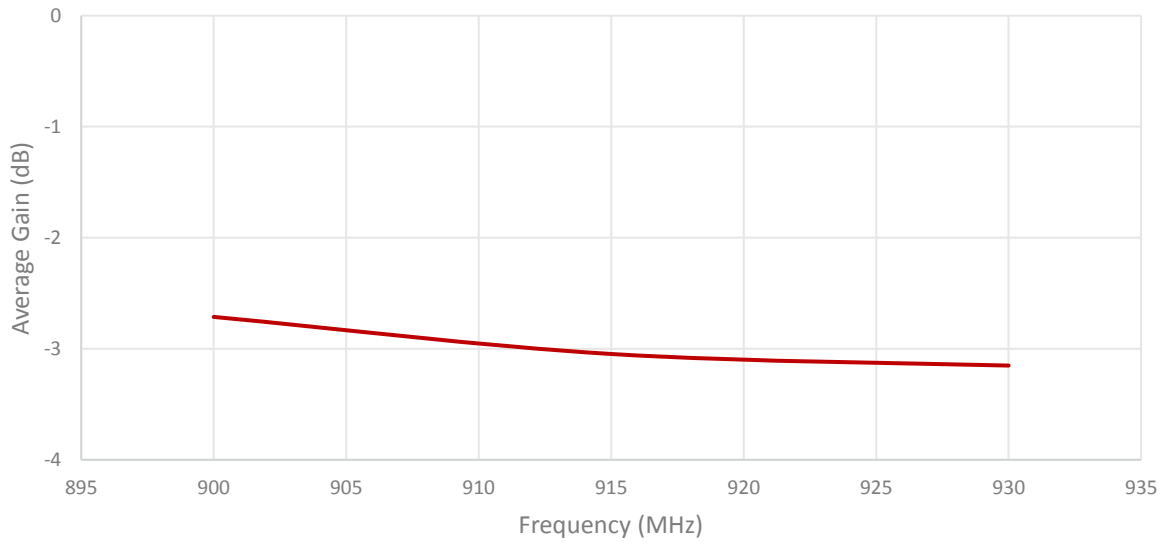

Radiation pattern reference

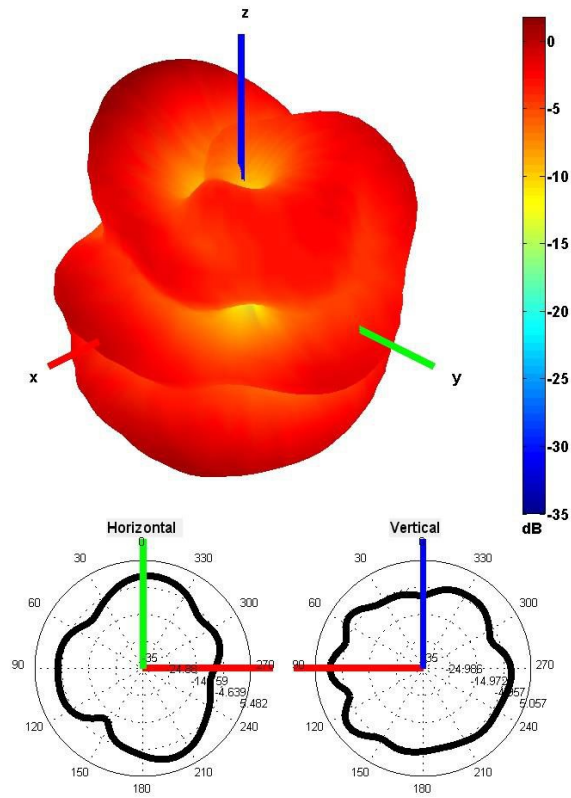

915 MHz Radiation pattern

4. Antenna drawings

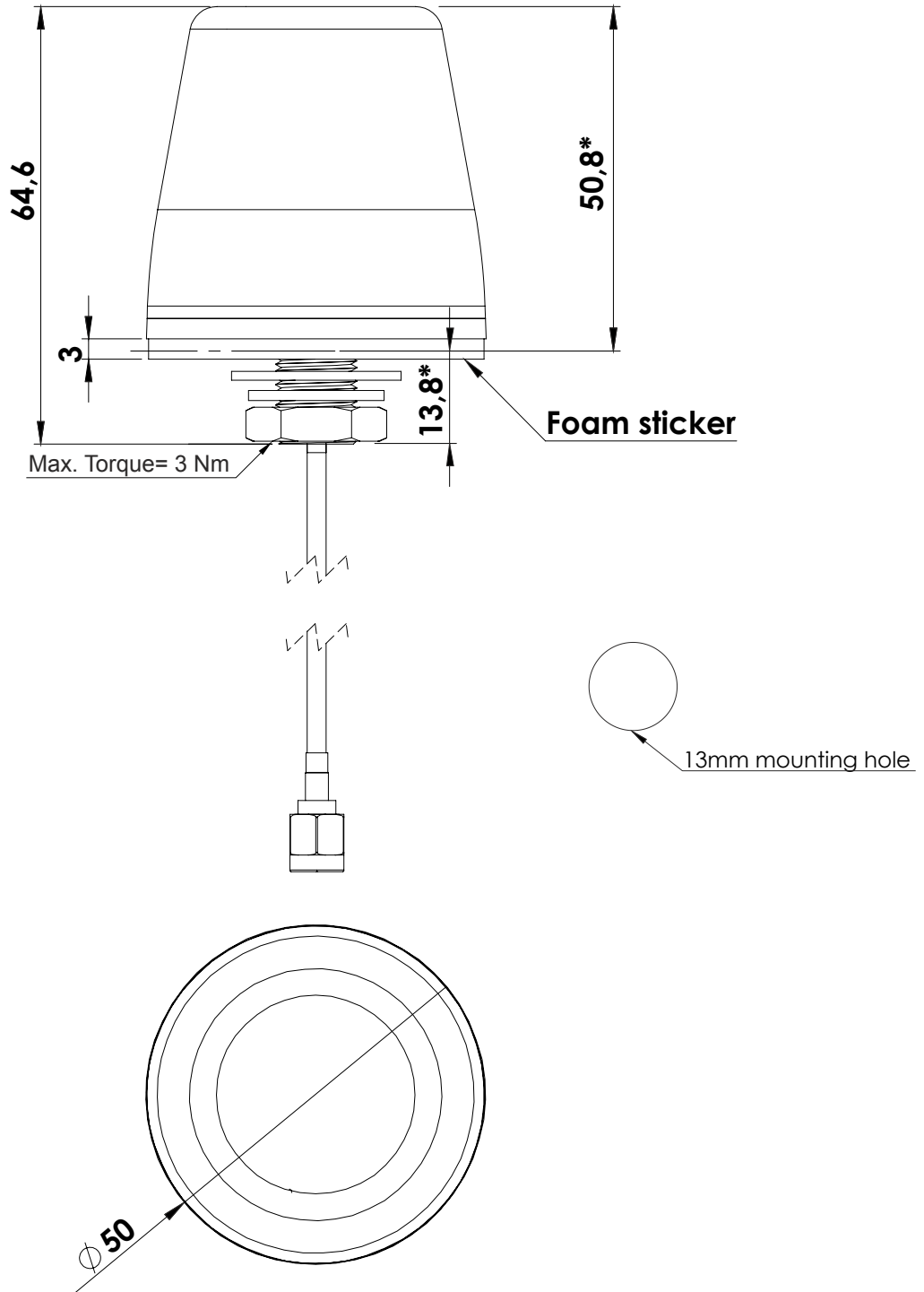

Note: Dimensions are in millimeters
*Dimensions are after mounting
**Max. Torque= 3 Nm

5. Antenna Images

