

## 2J4A86PCFa

2× 5G NR MIMO, 2× 2.4/5.0 GHz ISM MIMO and GNSS  
Adhesive Mount

### Key Features

#### Cable 1 - 2: 5G NR

- 617-960 MHz
- 1427-2690 MHz
- 3300-5000 MHz
- 5150-5925 MHz

#### Cable 3 - 4: 2.4/5.0 GHz ISM

- 2410-2490 MHz
- 4920-5925 MHz

#### Cable 5: GPS/GLONASS/BeiDou/QZSS/Galileo

- 1561-1606 MHz

Adhesive Mount

High Performance

Ground Plane Independent

Customizable Cable and Connector

Dimensions: 61.8 x 155.6 x 17.0 mm

Certificates: IP67, IP69



## 1. Antenna and electrical specifications

Cable 1

Parameters	5G NR Antenna			
Technologies	5G, 4G, 3G and 2G			
Standards	5G NR/4G LTE/FirstNet/CBRS/LPWA/CAT-X/CAT-Mx/CAT-NBx/NB-IoT/3G/2G			
Frequency (MHz)	617-960	1427-2690	3300-5000	5150-5925
Band (MHz)	600, 700, 850, 900	1500, 1600, 1700, 1800, 1900, 2000, 2100, 2300, 2500, 2600	3300, 3500, 3600, 3700, 4500	5200, 5500, 5800
5G NR Bands	n5, n8, 12, n20, n28, n71, n81, n82, n83,	n1, n2, n3, n7, n25, n34, n38, n39, n40, n41, n50, n51, n66, n70, n74, n75, n76, n80, n84, n86	n77, n78, n79	
4G LTE Bands	B5, B6, B8, B12, B13, B14, B17, B18, B19, B20, B26, B27, B28, B29, B44, B67, B68, B71, B85	B1, B2, B3, B4, B7, B9, B10, B11, B21, B23, B24, B25, B30, B32, B33, B34, B35, B36, B37, B38, B39, B40, B41, B45, B50, B51, B65, B66, B69, B70, B74, B75, B76	B22, B42, B43, B48, B49, B52	B46, B47, B252, B255
3G CELL Bands	B5, B6, B8, B12, B13, B14, B19, B20, B26	B1, B2, B3, B4, B7, B9, B10, B11, B21, B25, B32, B33, B34, B35, B36, B37, B38, B39, B40	B22	
2G CELL Bands	710, 750, 810T, 850, 900P, 900E, 900R	1800DCS, 1900PCS		
CDMA CELL Bands	BC0, BC2, BC3, BC7, BC9, BC10, BC12, BC18, BC19	BC1, BC4, BC6, BC8, BC13, BC14, BC15, BC16, BC20, BC21		
Return Loss (dB)	~-9.1	~-7.0	~-6.9	~-6.7
VSWR	~2.7:1	~2.9:1	~2.9:1	~3.4:1
Efficiency (%)	~45.8	~39.6	~32.2	~14.4
Peak Gain (dBi)	~1.2	~1.3	~0.6	~-2.7
Average Gain (dB)	~-3.4	~-4.2	~-5.0	~-8.6
Impedance (Ohm)	50			
Polarisation	Linear			
Radiation Pattern	Omni-Directional			
Max. Input Power (W)	35			
Connector Type	SMA-Male Standard (Other Connectors Available)			
Cable Length	300 cm Standard (Any Cable Length Available)			
Cable Type	LL195 Standard (Other Cables Available)			

Cable 2

Parameters	5GNR Antenna			
Technologies	5G, 4G, 3G and 2G			
Standards	5GNR/4GLTE/FirstNet/CBRS/LPWA/CAT-X/CAT-Mx/CAT-NBx/NB-IoT/3G/2G			
Frequency (MHz)	617-960	1427-2690	3300-5000	5150-5925
Band (MHz)	600, 700, 850, 900	1500, 1600, 1700, 1800, 1900, 2000, 2100, 2300, 2500, 2600	3300, 3500, 3600, 3700, 4500	5200, 5500, 5800
5GNR Bands	n5, n8 ,12, n20, n28, n71, n81, n82, n83,	n1, n2, n3, n7, n25, n34, n38, n39, n40, n41, n50, n51, n66, n70, n74, n75, n76, n80, n84, n86	n77, n78, n79	
4GLTE Bands	B5, B6, B8, B12, B13, B14, B17, B18, B19, B20, B26, B27, B28, B29, B44, B67, B68, B71, B85	B1, B2, B3, B4, B7, B9, B10, B11, B21, B23, B24, B25, B30, B32, B33, B34, B35, B36, B37, B38, B39, B40, B41, B45, B50, B51, B65, B66, B69, B70, B74, B75, B76	B22, B42, B43, B48, B49, B52	B46, B47, B252, B255
3GCELL Bands	B5, B6, B8, B12, B13, B14, B19, B20, B26	B1, B2, B3, B4, B7, B9, B10, B11, B21, B25, B32, B33, B34, B35, B36, B37, B38, B39, B40	B22	
2GCELL Bands	710, 750, 810T, 850, 900P, 900E, 900R	1800DCS, 1900PCS		
CDMACELL Bands	BC0, BC2, BC3, BC7, BC9, BC10, BC12, BC18, BC19	BC1, BC4, BC6, BC8, BC13, BC14, BC15, BC16, BC20, BC21		
Return Loss (dB)	~-7.8	~-8.8	~-5.1	~-4.3
VSWR	~2.7:1	~2.7:1	~3.8:1	~4.2:1
Efficiency (%)	~43.0	~40.0	~25.1	~22.7
Peak Gain (dBi)	~0.4	~1.7	~-0.1	~-1.4
Average Gain (dB)	~-3.7	~-4.2	~-6.3	~-6.7
Impedance (Ohm)	50			
Polarisation	Linear			
Radiation Pattern	Omni-Directional			
Max. Input Power (W)	35			
Connector Type	SMA-Male Standard (Other Connectors Available)			
Cable Length	300 cm Standard (Any Cable Length Available)			
Cable Type	LL195 Standard (Other Cables Available)			

**Cable 3**

Parameters	2.4/5.0 GHz ISM Antenna	
<b>Standards</b>	WiFi, BT, ZigBee, ISM	
<b>Band (MHz)</b>	2.4 GHz	5.0 GHz
<b>Frequency (MHz)</b>	2410-2490	4920-5925
<b>Return Loss (dB)</b>	~-7.8	~-9.8
<b>VSWR</b>	~2.4:1	~2.0:1
<b>Efficiency (%)</b>	~24.3	~47.2
<b>Peak Gain (dBi)</b>	~-1.5	~-3.8
<b>Average Gain (dB)</b>	~-6.3	~-3.3
<b>Impedance (Ohm)</b>	50	
<b>Polarisation</b>	Linear	
<b>Radiation Pattern</b>	Omni-Directional	
<b>Max. Input Power (W)</b>	25	
<b>Connector Type</b>	SMA-Male-RP Standard (Other Connectors Available)	
<b>Cable Length</b>	300 cm Standard (Any Cable Length Available)	
<b>Cable Type</b>	LL195 Standard (Other Cables Available)	

**Cable 4**

Parameters	2.4/5.0 GHz ISM Antenna	
<b>Standards</b>	WiFi, BT, ZigBee, ISM	
<b>Band (MHz)</b>	2.4 GHz	5.0 GHz
<b>Frequency (MHz)</b>	2410-2490	4920-5925
<b>Return Loss (dB)</b>	~-11.6	~-18.3
<b>VSWR</b>	~1.7:1	~1.4:1
<b>Efficiency (%)</b>	~39.0	~55.9
<b>Peak Gain (dBi)</b>	~-0.8	~-4.9
<b>Average Gain (dB)</b>	~-4.3	~-2.6
<b>Impedance (Ohm)</b>	50	
<b>Polarisation</b>	Linear	
<b>Radiation Pattern</b>	Omni-Directional	
<b>Max. Input Power (W)</b>	25	
<b>Connector Type</b>	SMA-Male-RP Standard (Other Connectors Available)	
<b>Cable Length</b>	300 cm Standard (Any Cable Length Available)	
<b>Cable Type</b>	LL195 Standard (Other Cables Available)	

**Antenna Measurement Conditions:**

Mounted on Plastic Plate of 30 x 30 cm

100 cm of Cable LL195

Measured in Certified CTIA 3D Anechoic Chamber

Cable 5

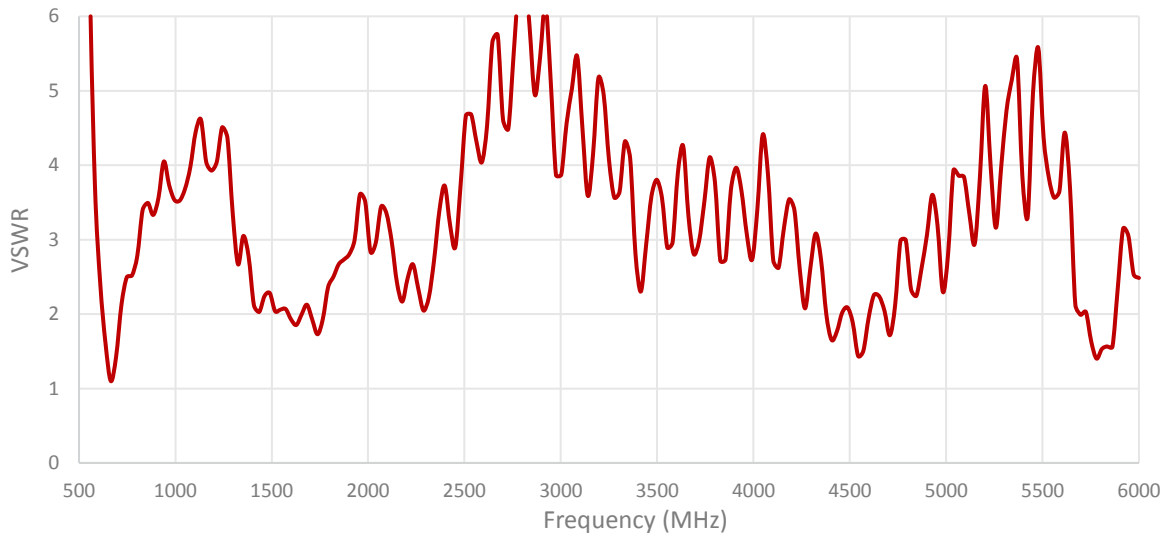
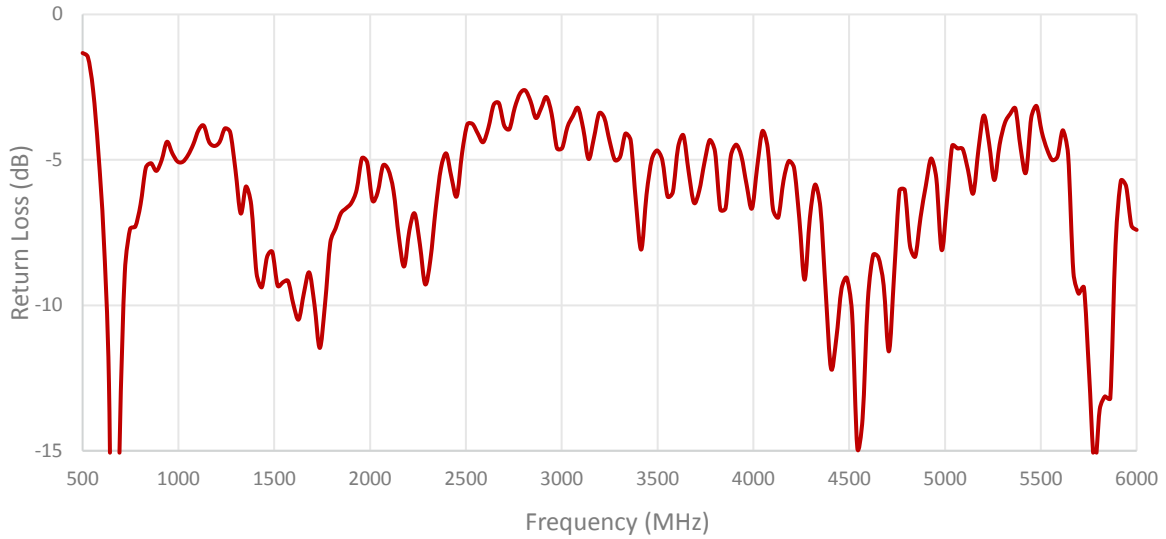
Parameters	GPS/GLONASS/BeiDou Antenna		
	BeiDou	GPS/QZSS/Galileo	GLONASS
<b>Standards</b>			
<b>Band (MHz)</b>	1561	1575	1602
<b>Frequency(MHz)</b>	1561.098	1575.42	1598-1610
<b>Patch Size (mm)</b>		25 x 25 x 4	
<b>Return Loss (dB)</b>		<=-15.0 dB	
<b>VSWR</b>		<=1.4:1 dB	
<b>Impedance</b>		50	
<b>Radiation Pattern</b>		Hemispherical	
<b>Polarization</b>		RHCP	
<b>Saw Filter</b>		Pre-filter	
<b>Active Gain (dB)</b>		28 @ 2.7 V	
<b>Noise Figure (dB)</b>		1.5 Typ	
<b>Voltage (V)</b>		1.5 – 3.6	
<b>Current Consumption (mA)</b>		9 Typ	
<b>Power Consumption (mW)</b>		24.3 Typ	
<b>ESD Protection (kV)</b>		2kV	
<b>Connector Type</b>	SMA-Male Standard (Other Connectors Available)		
<b>Cable Length</b>	300 cm Standard (Any Cable Length Available)		
<b>Cable Type</b>	LMR100 Standard (Other Cables Available)		

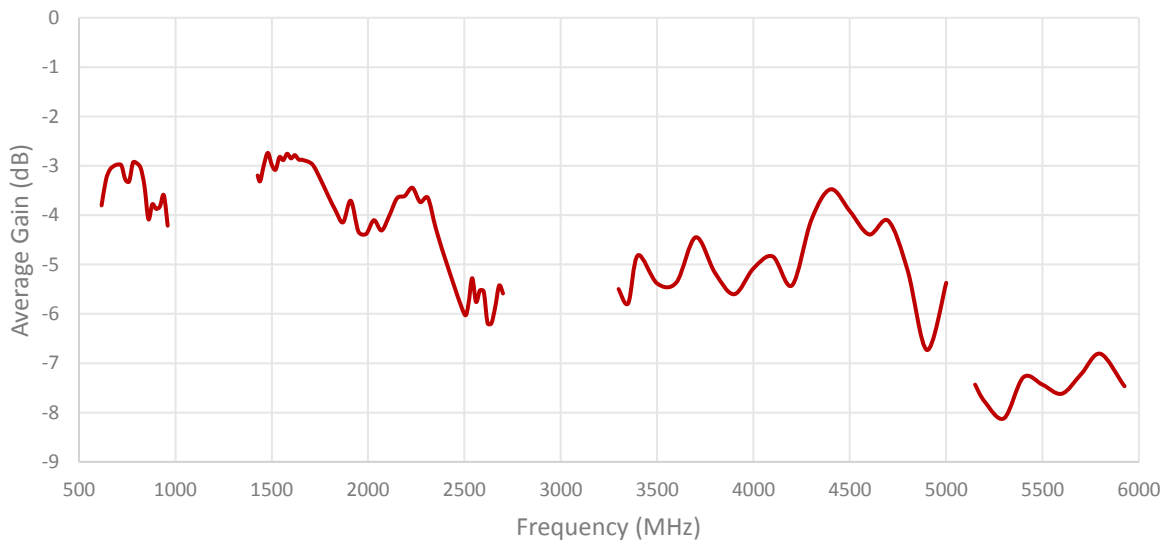
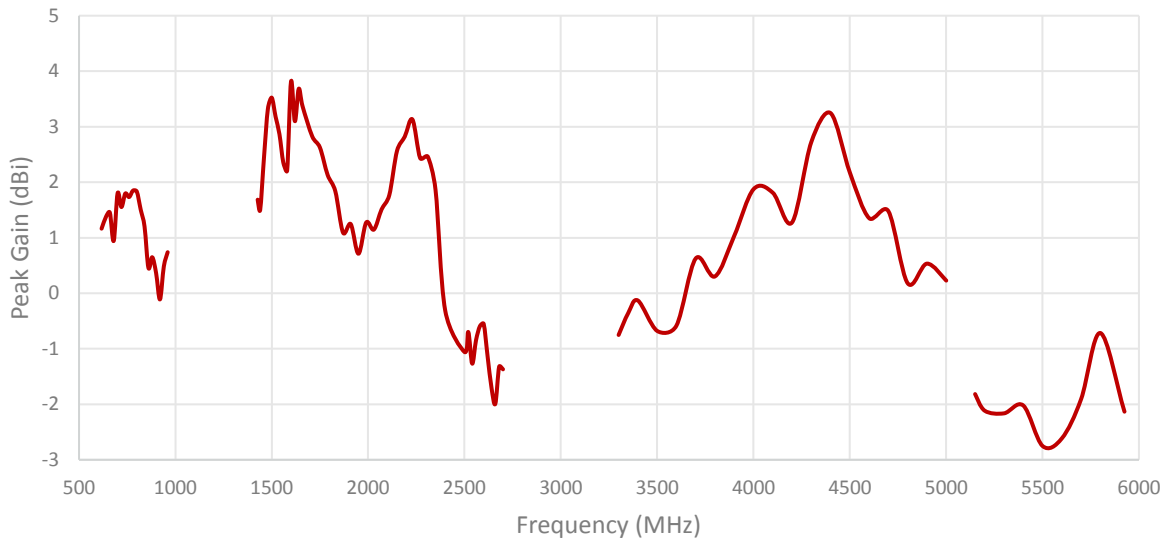
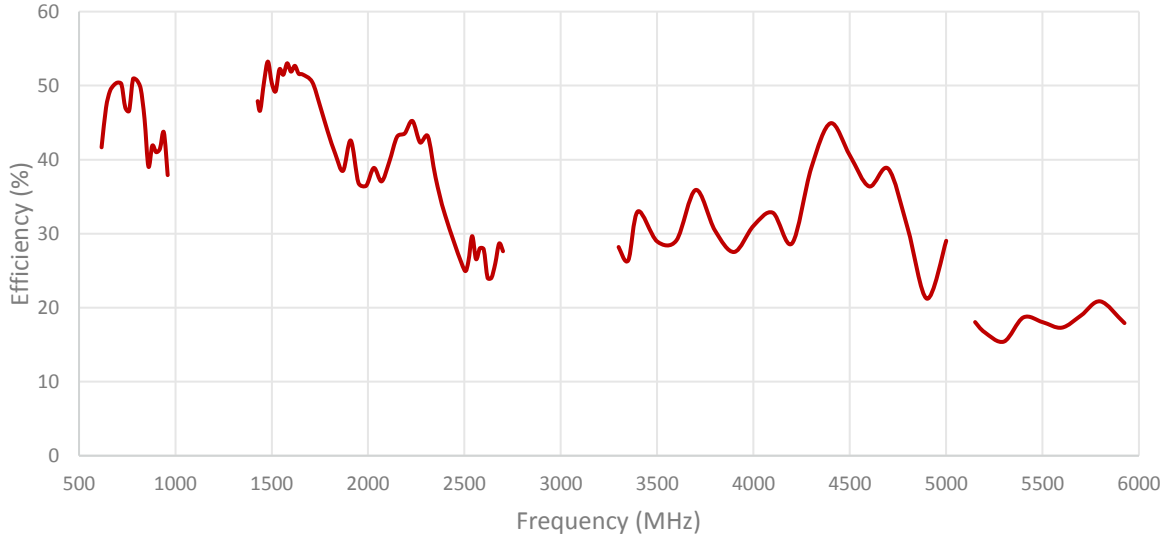
## 2. Mechanical and environmental specifications

Specifications	2J4A86PCFa
<b>Mounting Type</b>	Adhesive Mount
<b>Dimensions (mm)</b>	61.8 x 155.6 x 17.0
<b>Radome Type</b>	ABS UV Stable
<b>Radome color</b>	Black
<b>Operating Temperature (C)</b>	-40 to +85
<b>Storage Temperature (C)</b>	-40 to +85
<b>Substance Compliance</b>	RoHS
<b>Certificates</b>	IP67, IP69, CE, Vibration

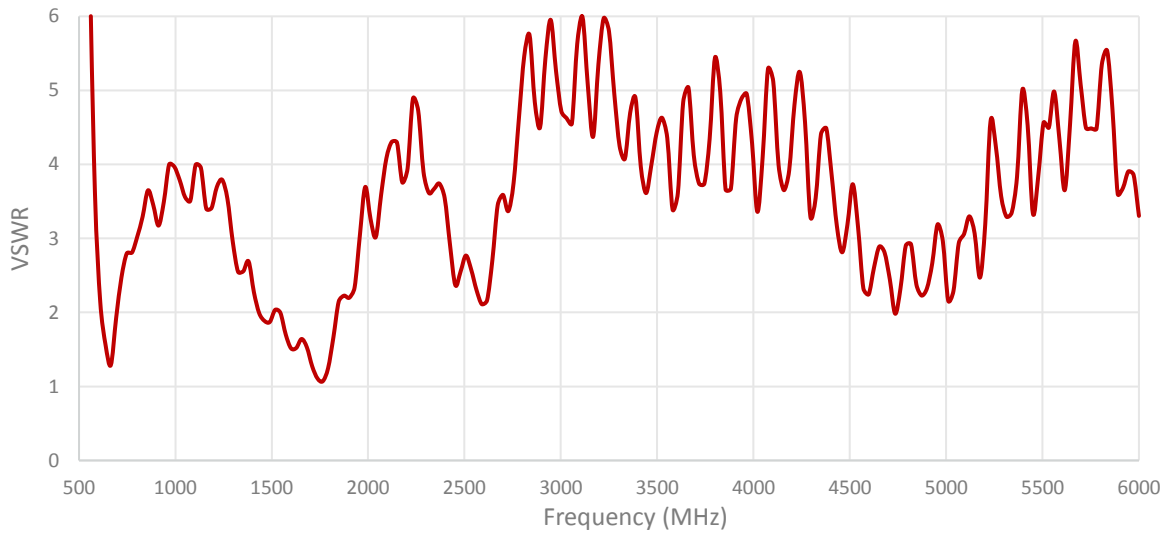
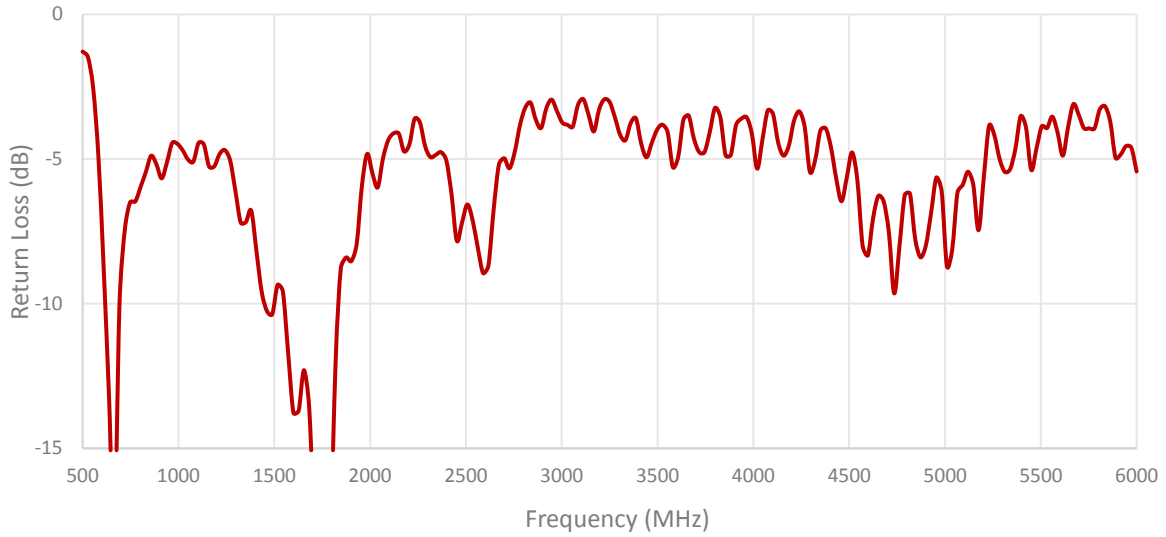
### 3. Antenna parameters

Cable 1: 5GNR

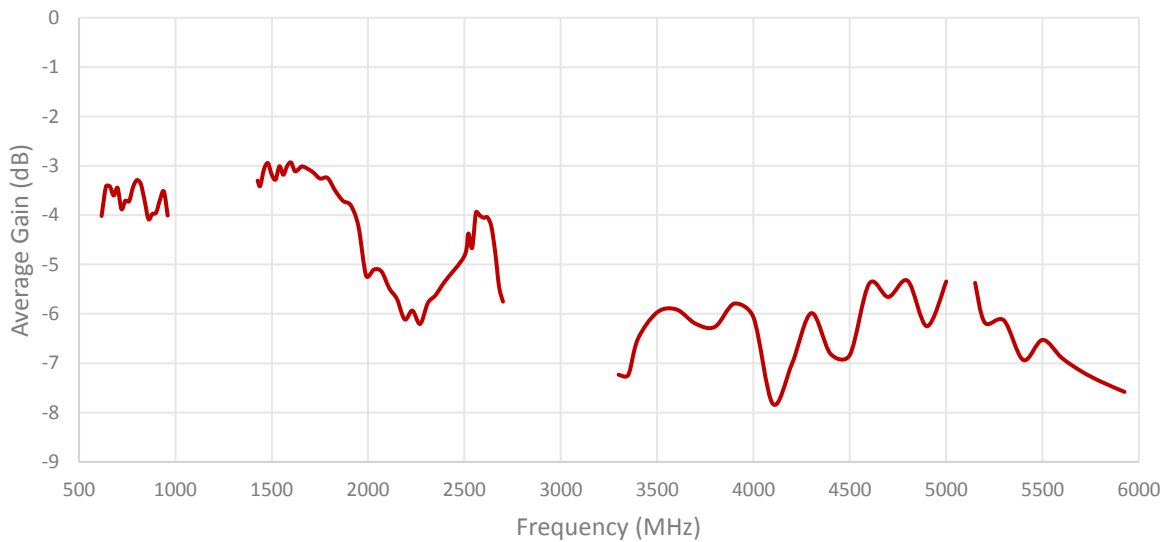
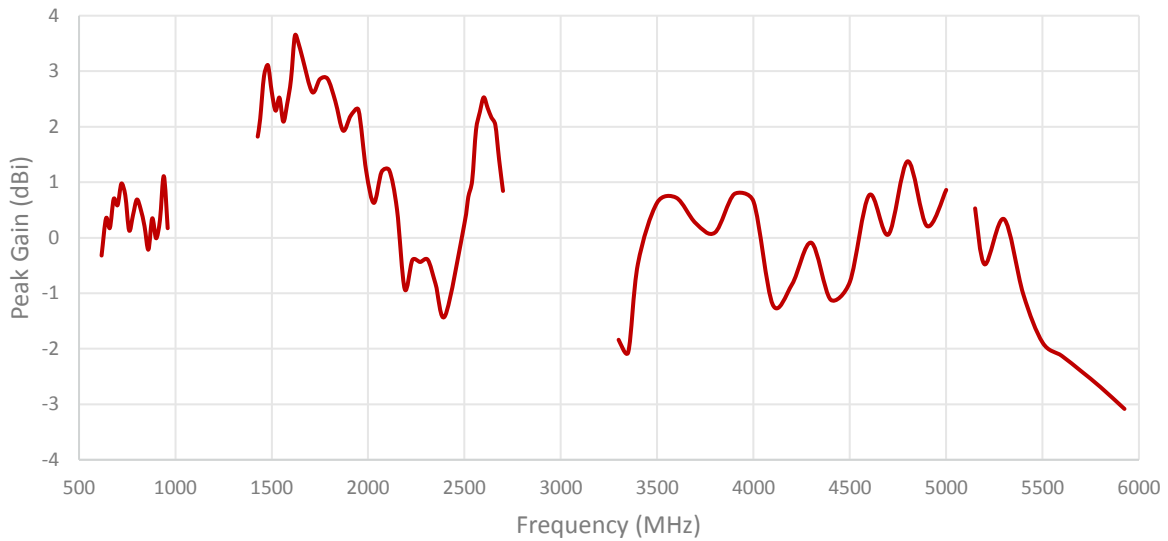
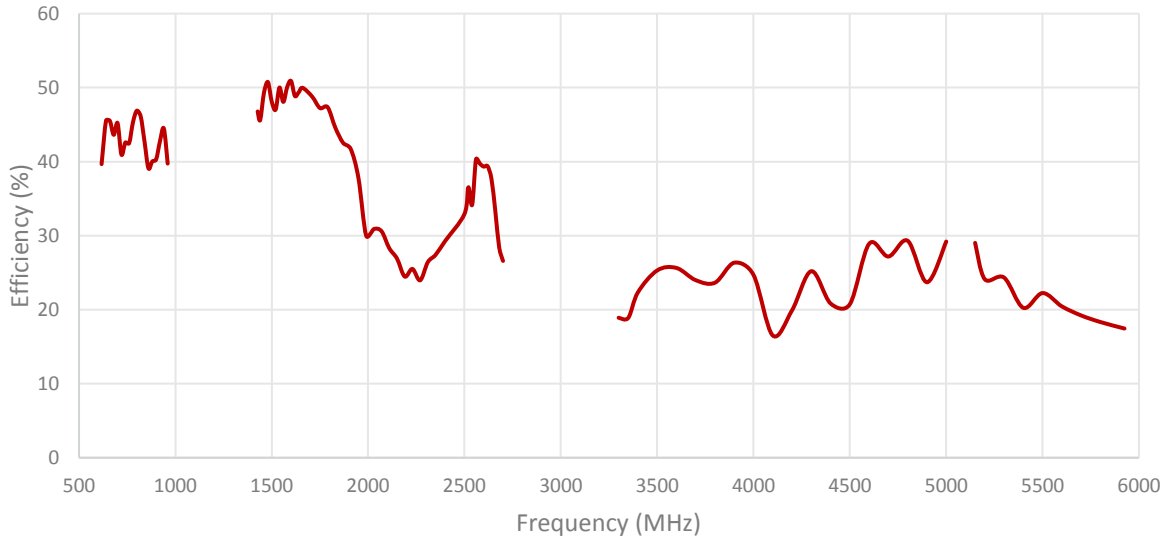




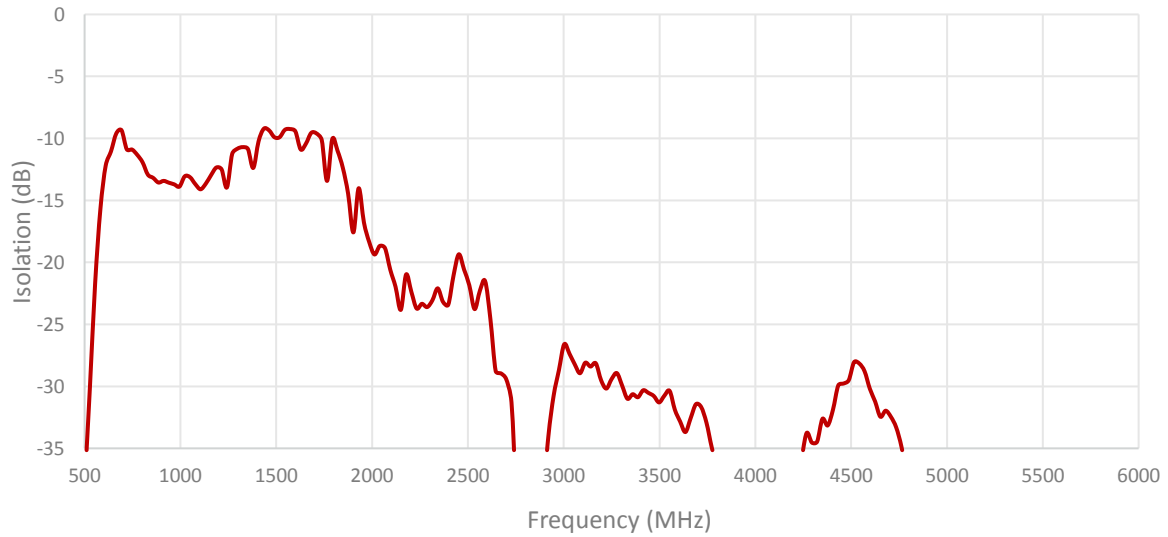
**Cable 2: 5GNR**



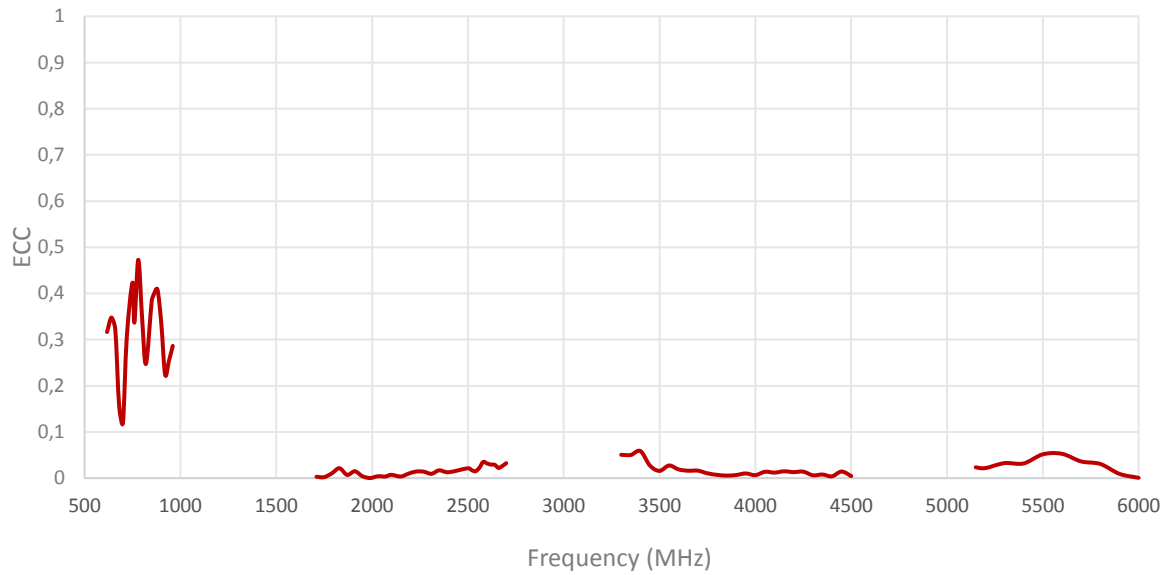




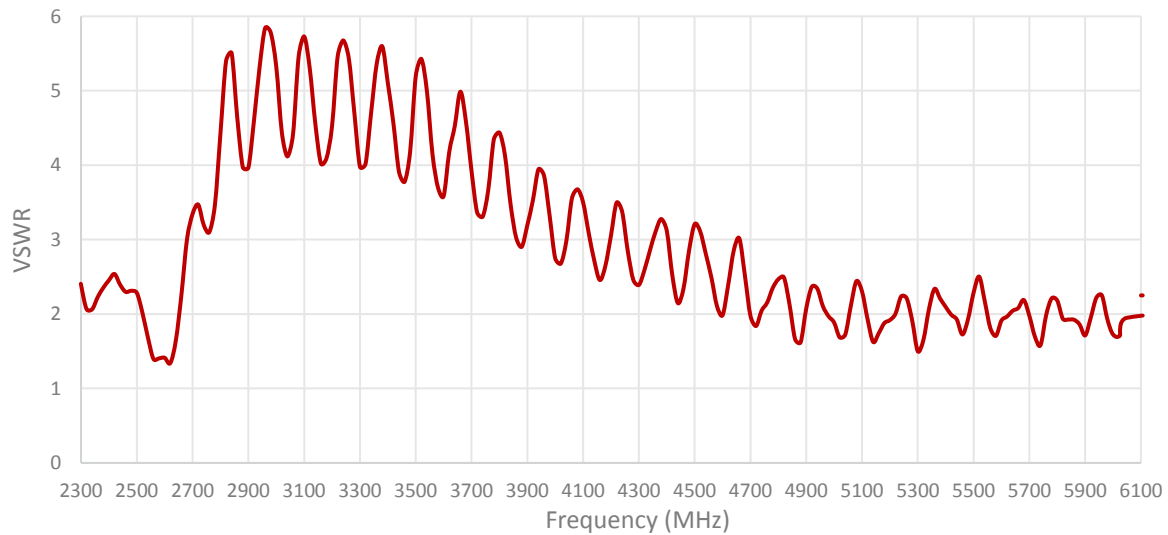
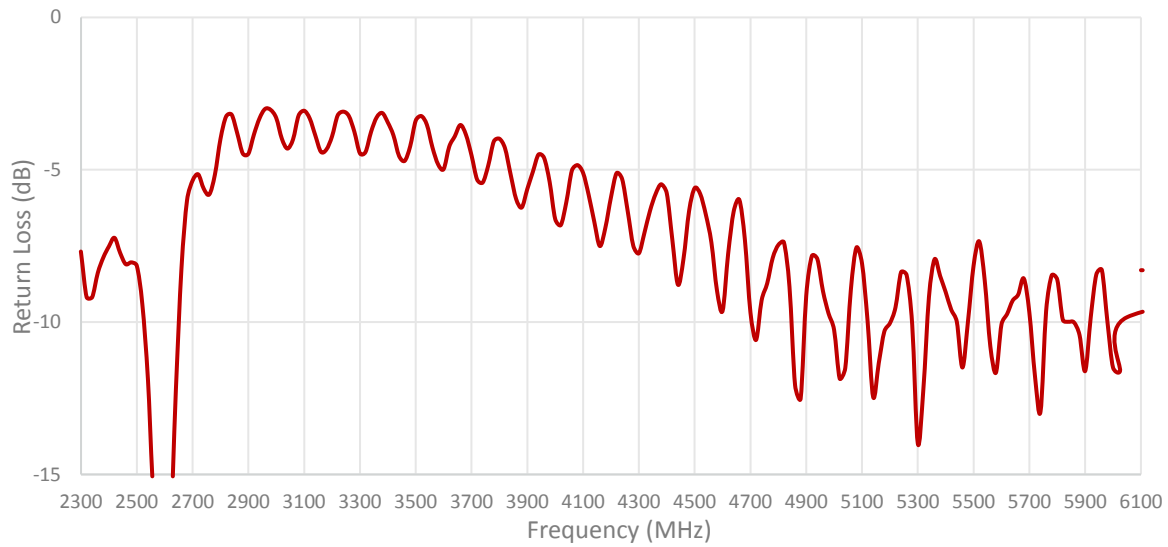
**ISOLATION FOR CABLES 1 AND 2**

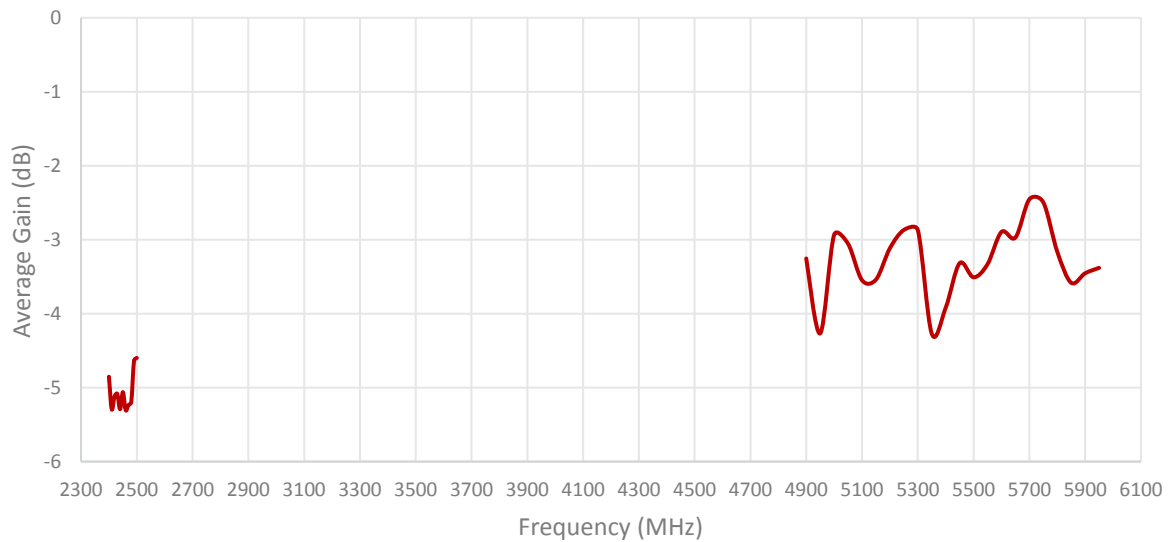
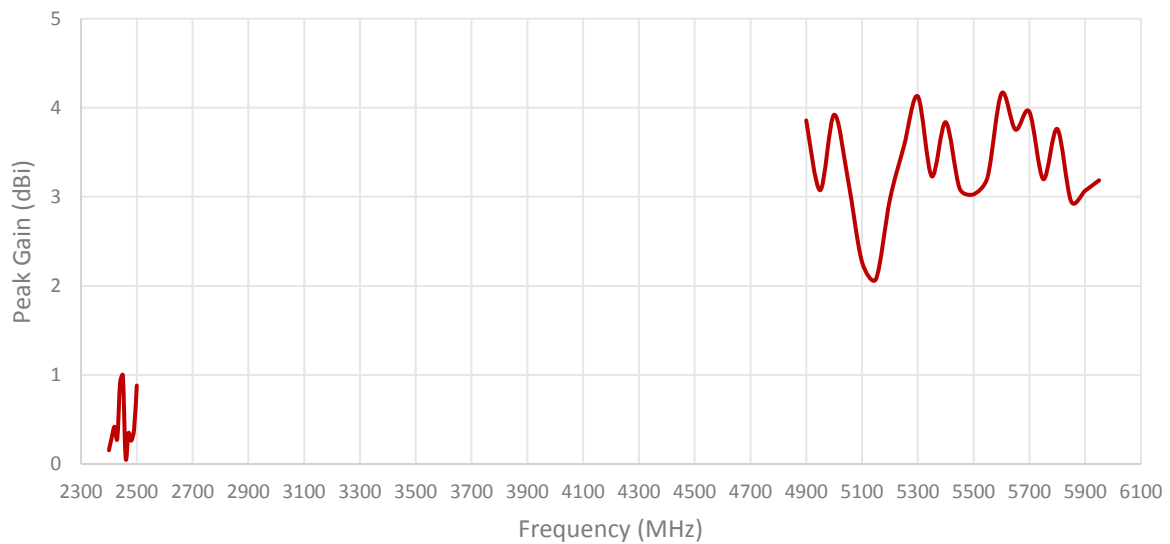
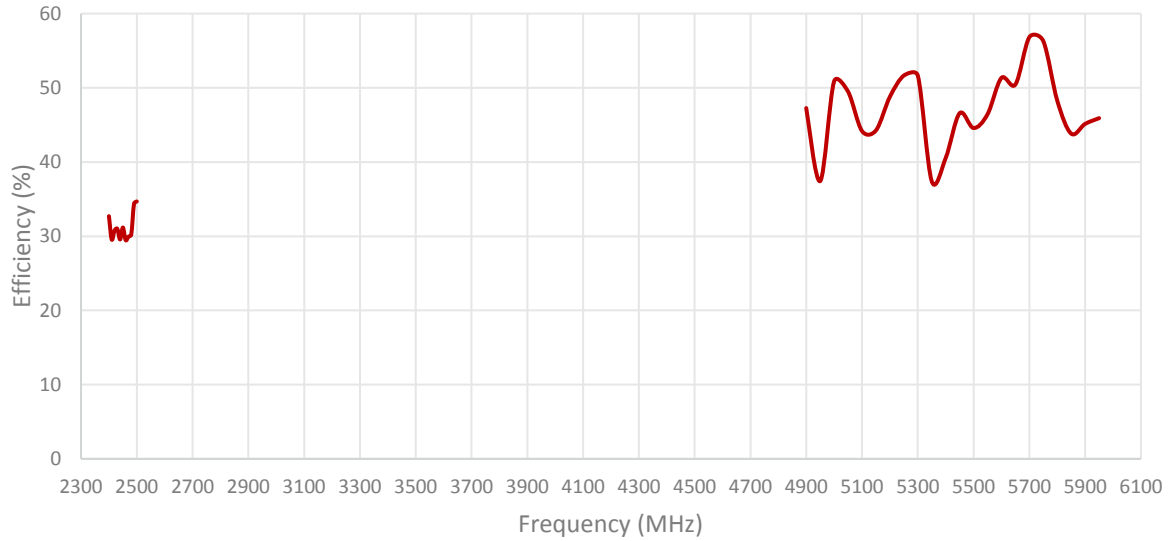


**ENVELOPE CORRELATION COEFFICIENT FOR CABLES 1 AND 2**

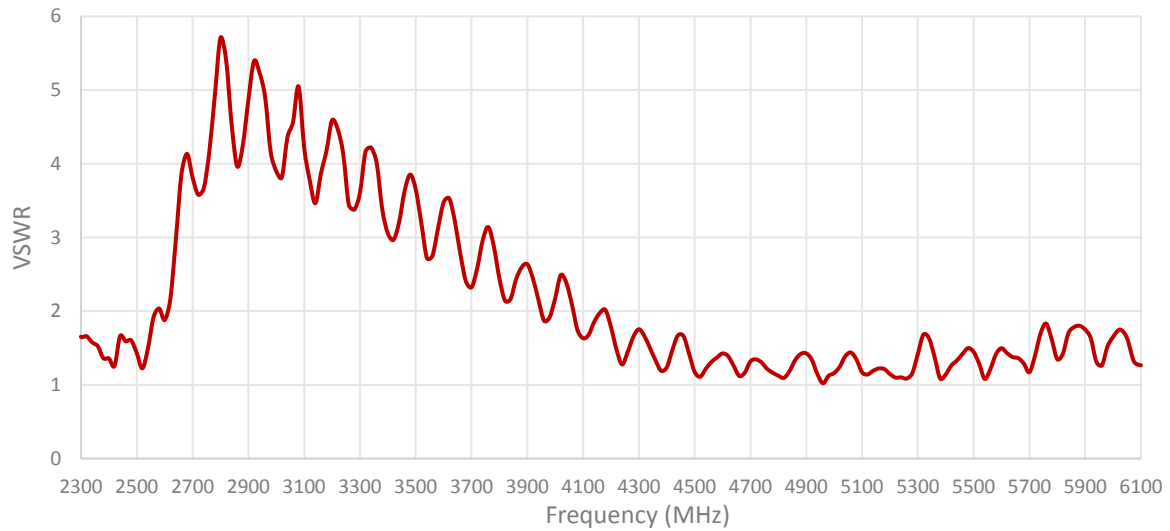
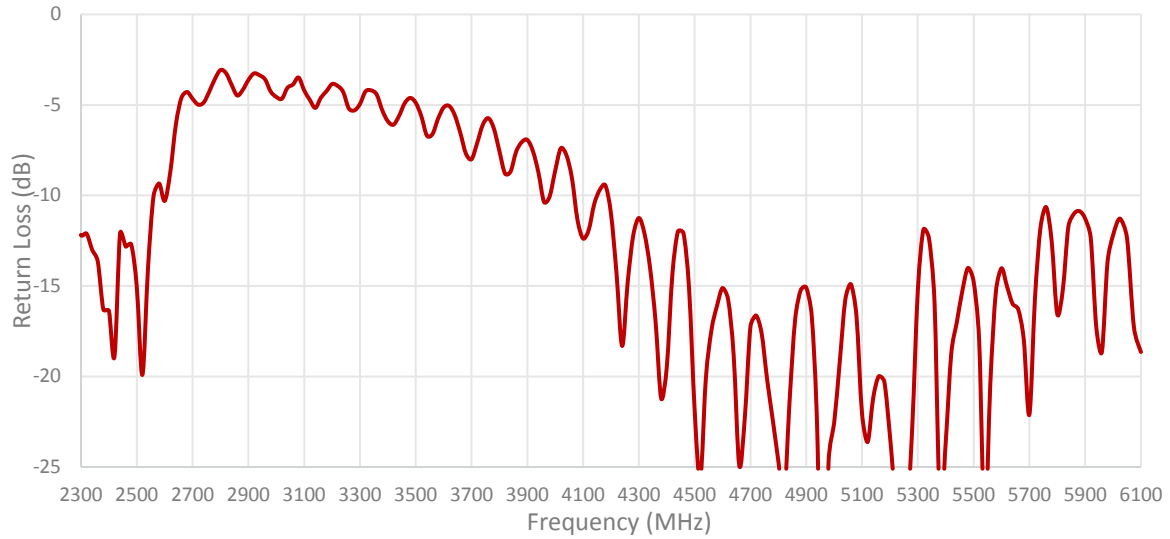


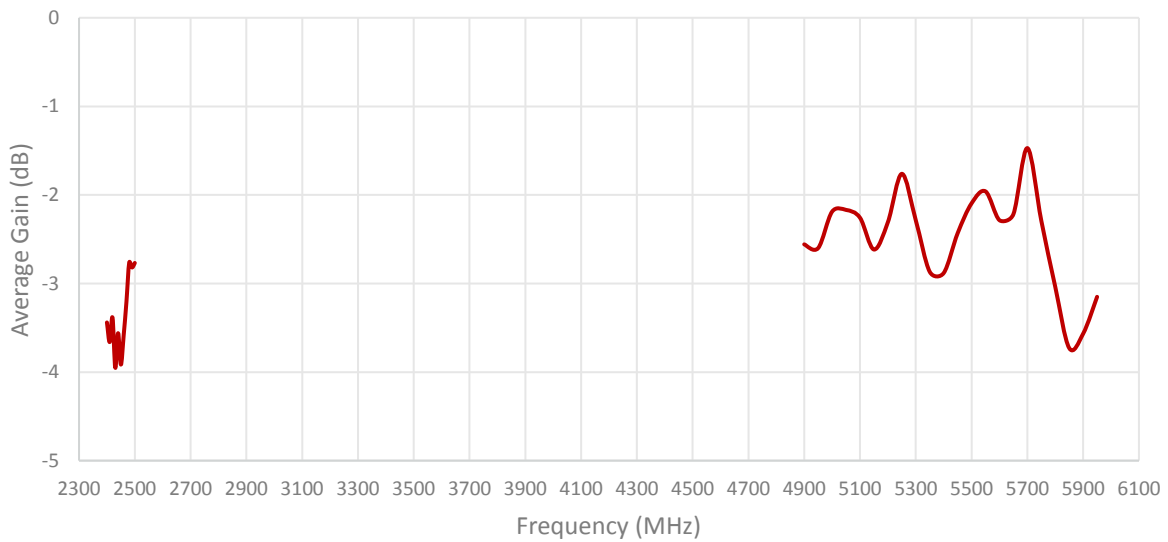
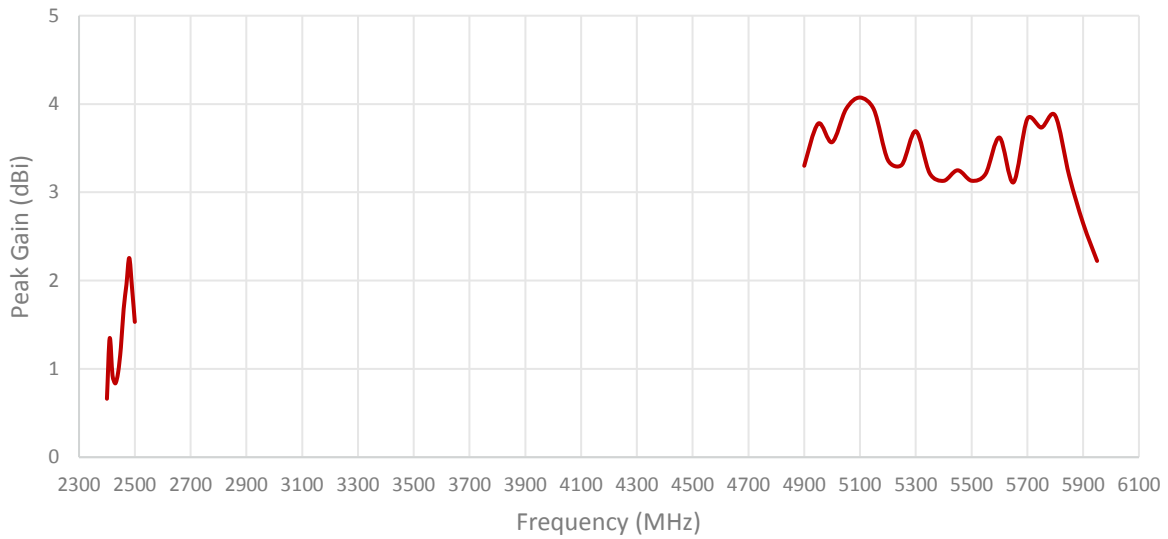
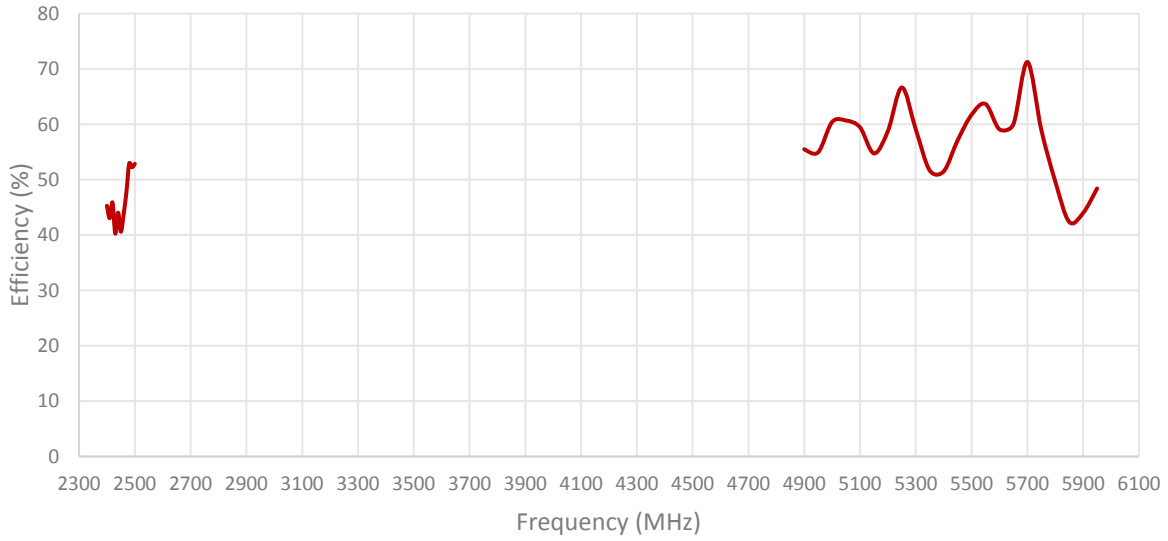
**Cable 3: 2.4/5.0 GHz ISM**



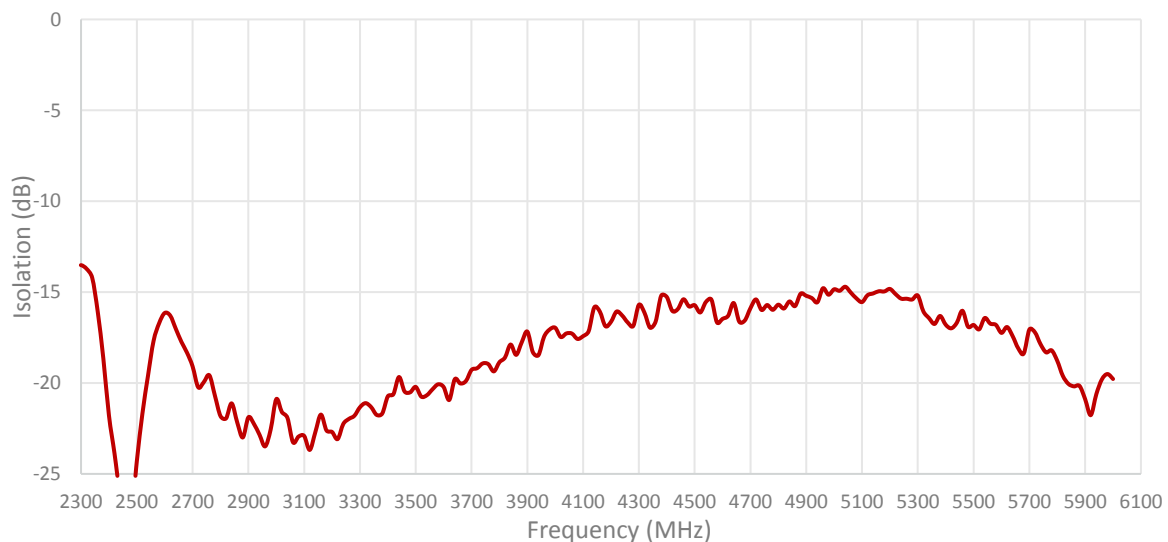


**Table 4: 2.4/5.0 GHz ISM**

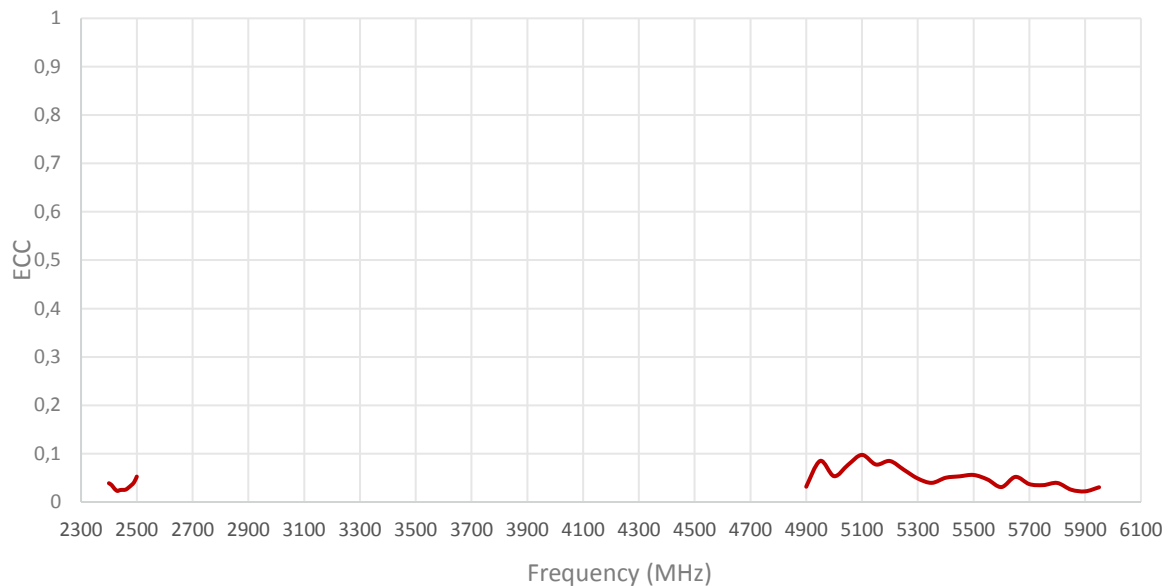


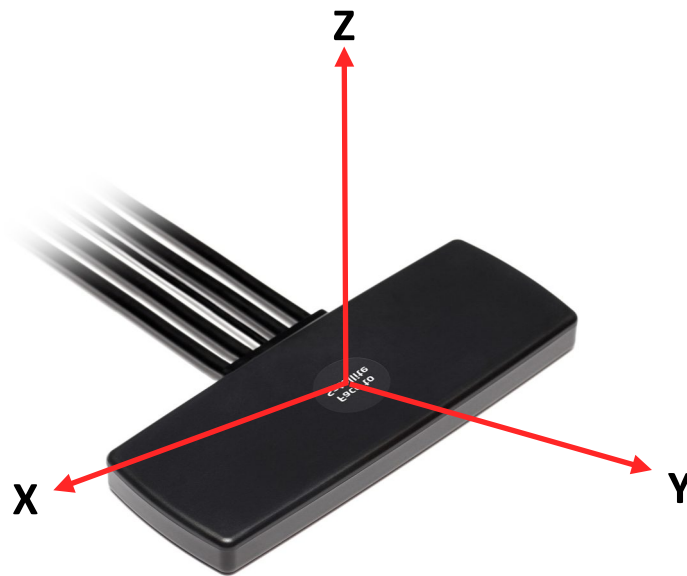


**ISOLATION FOR CABLES 3 AND 4**



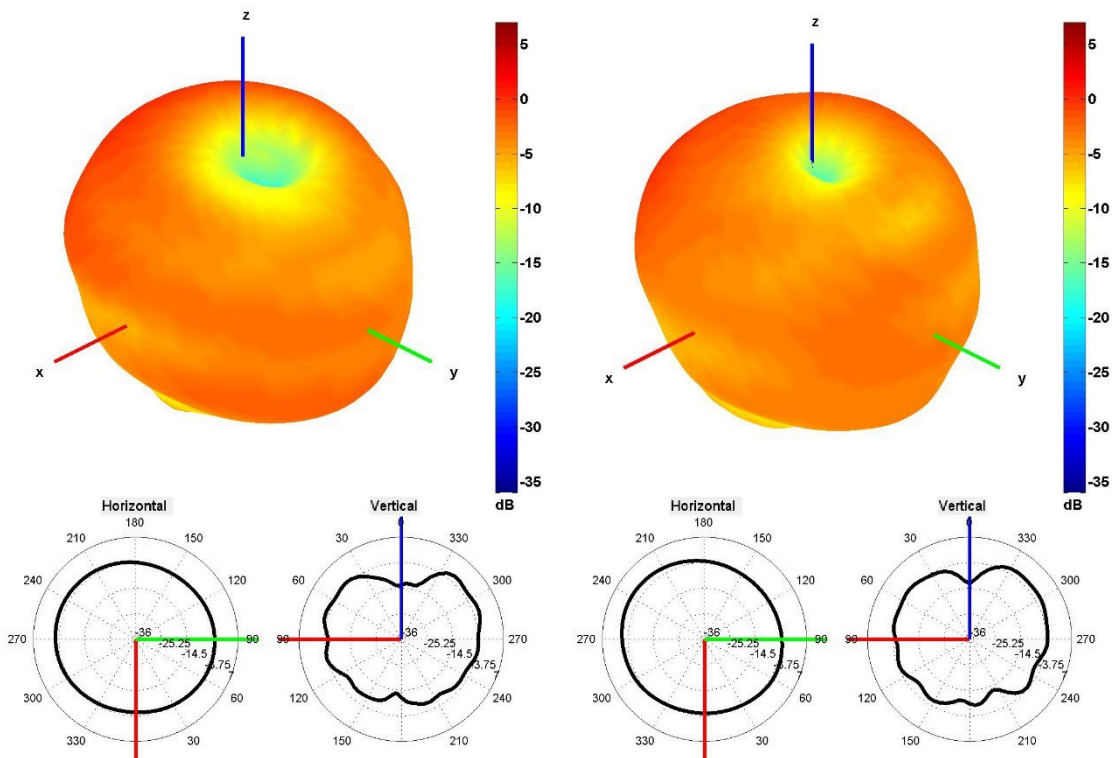
**ENVELOPE CORRELATION COEFFICIENT FOR CABLES 3 AND 4**





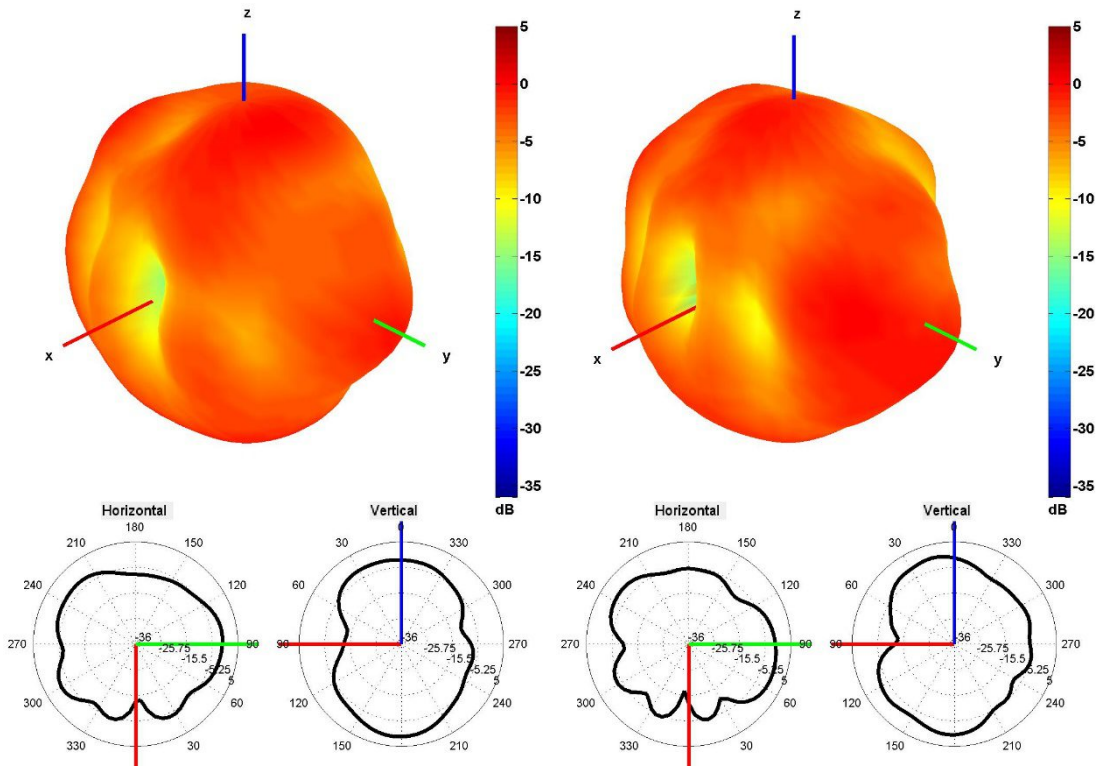
Radiation pattern reference

Cable 1: 5GNR

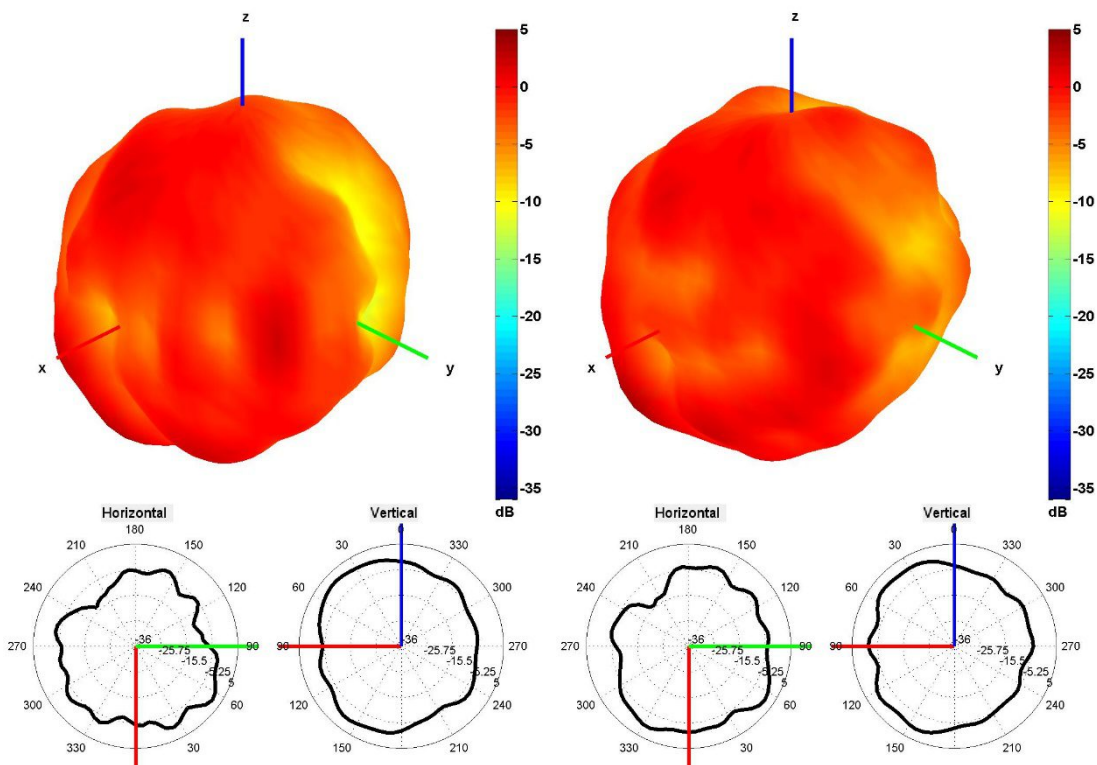


650 and 750 MHz Radiation pattern

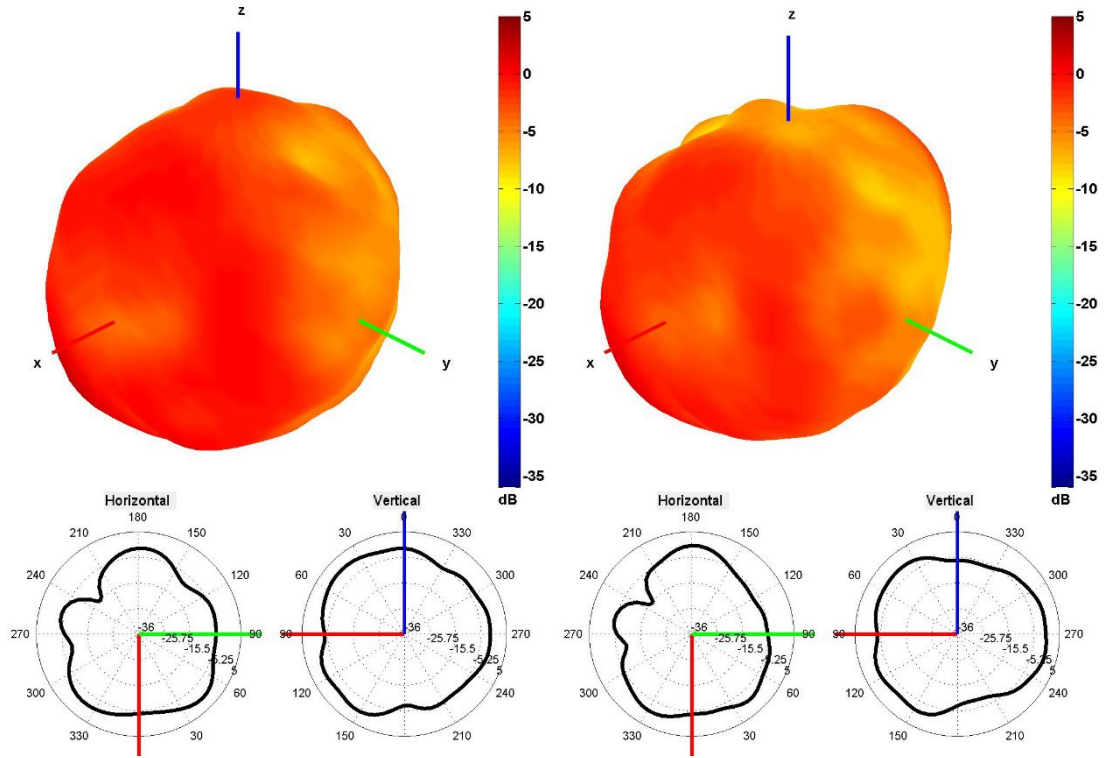




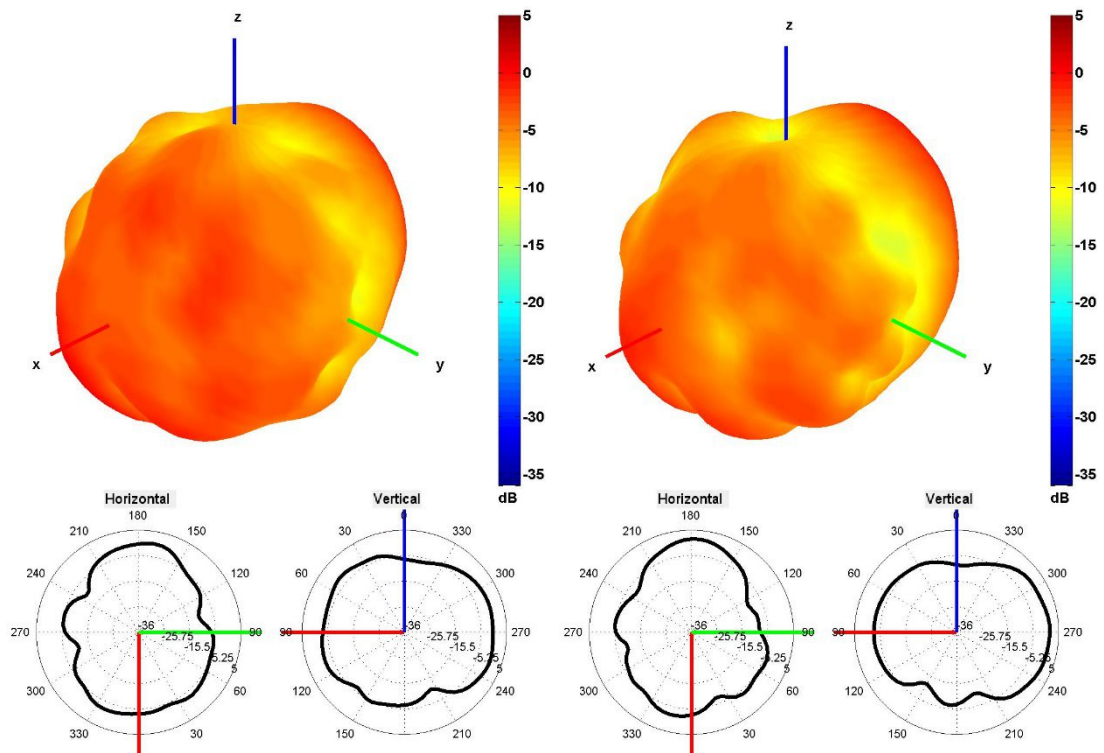
850 and 940 MHz Radiation pattern



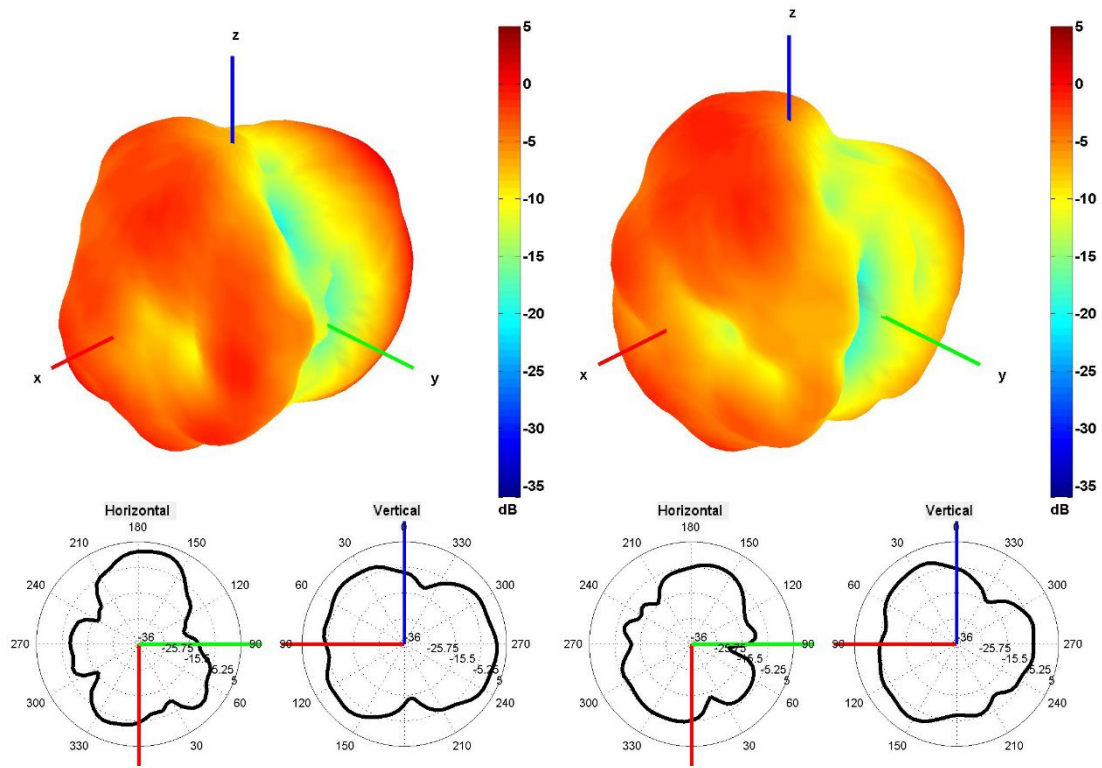
1500 and 1600 MHz Radiation pattern



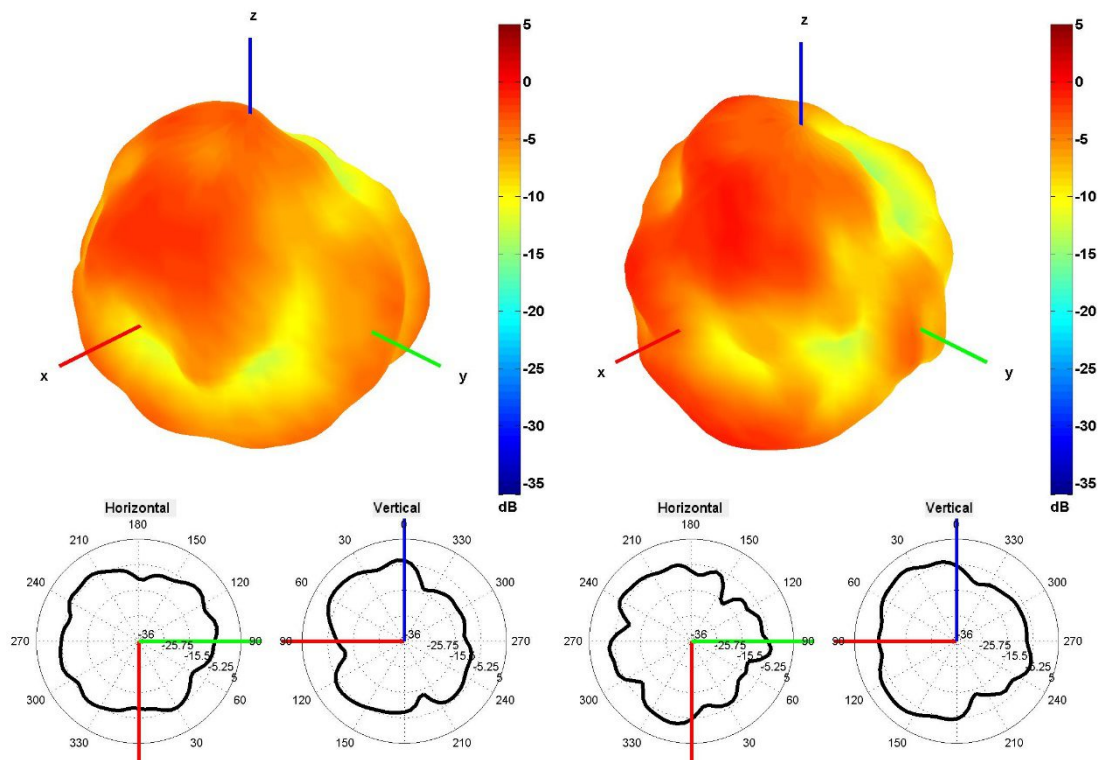
1750 and 1850 MHz Radiation pattern



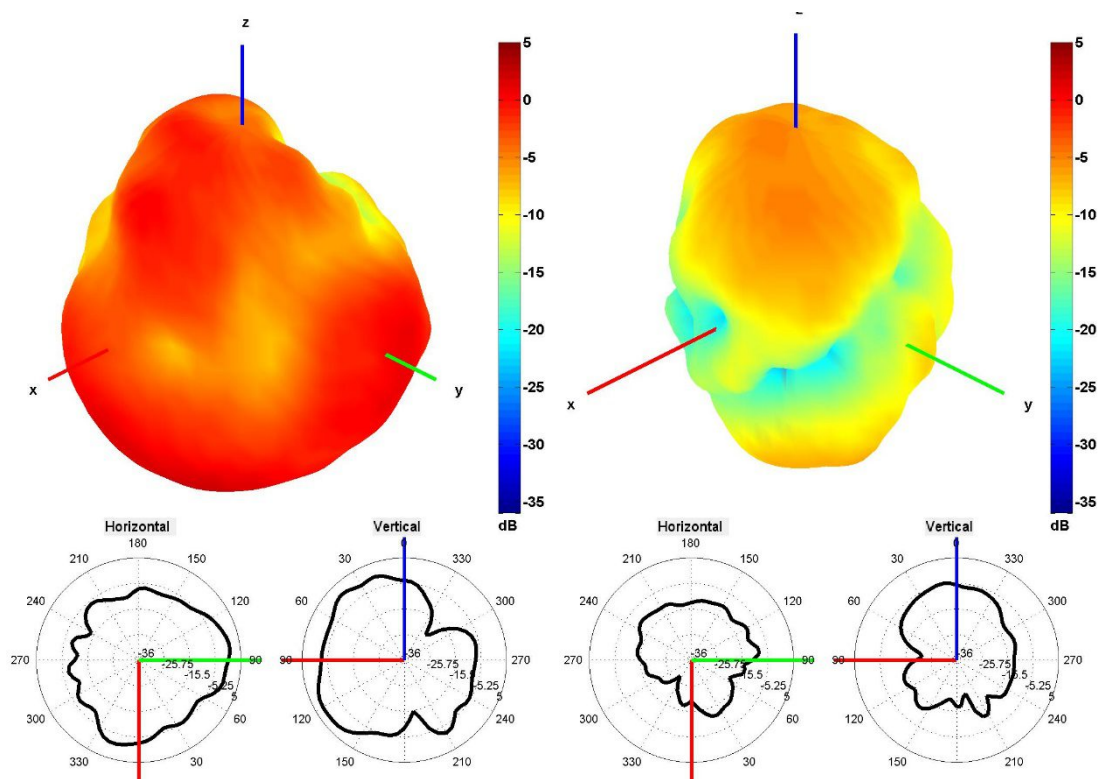
1950 and 2100 MHz Radiation pattern



2350 and 2600 MHz Radiation pattern

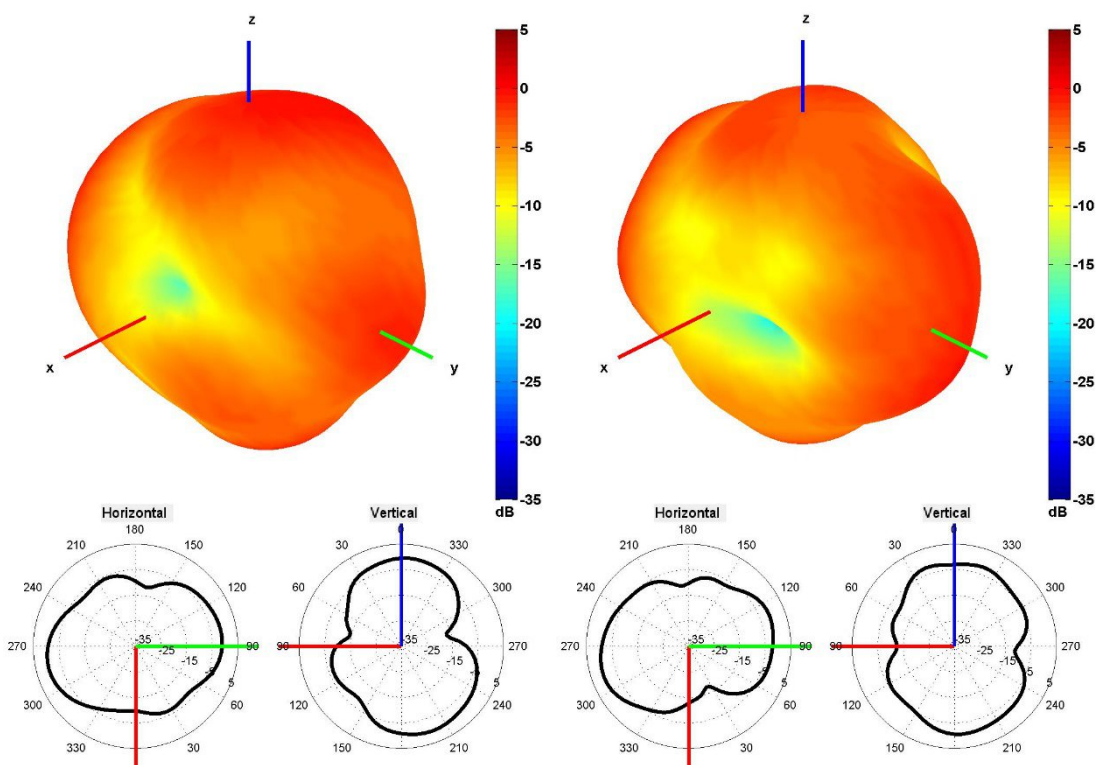


3350 and 3600 MHz Radiation pattern



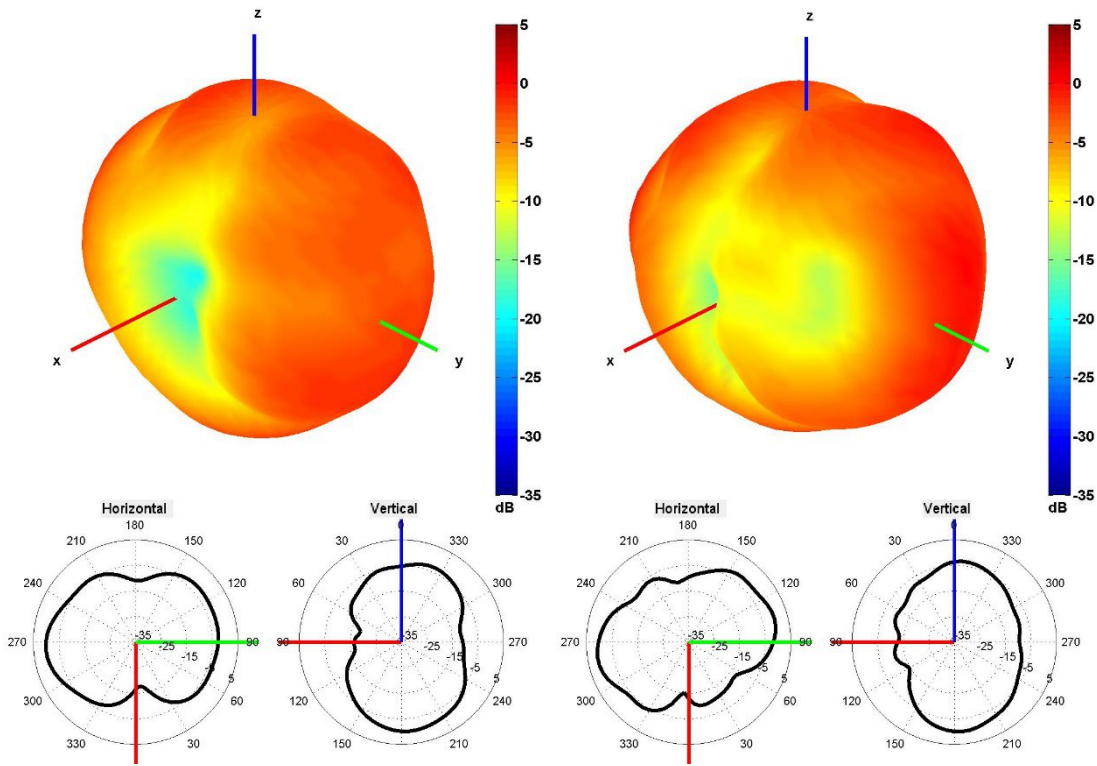
4500 and 5500 MHz Radiation pattern

Cable 2: 5GNR

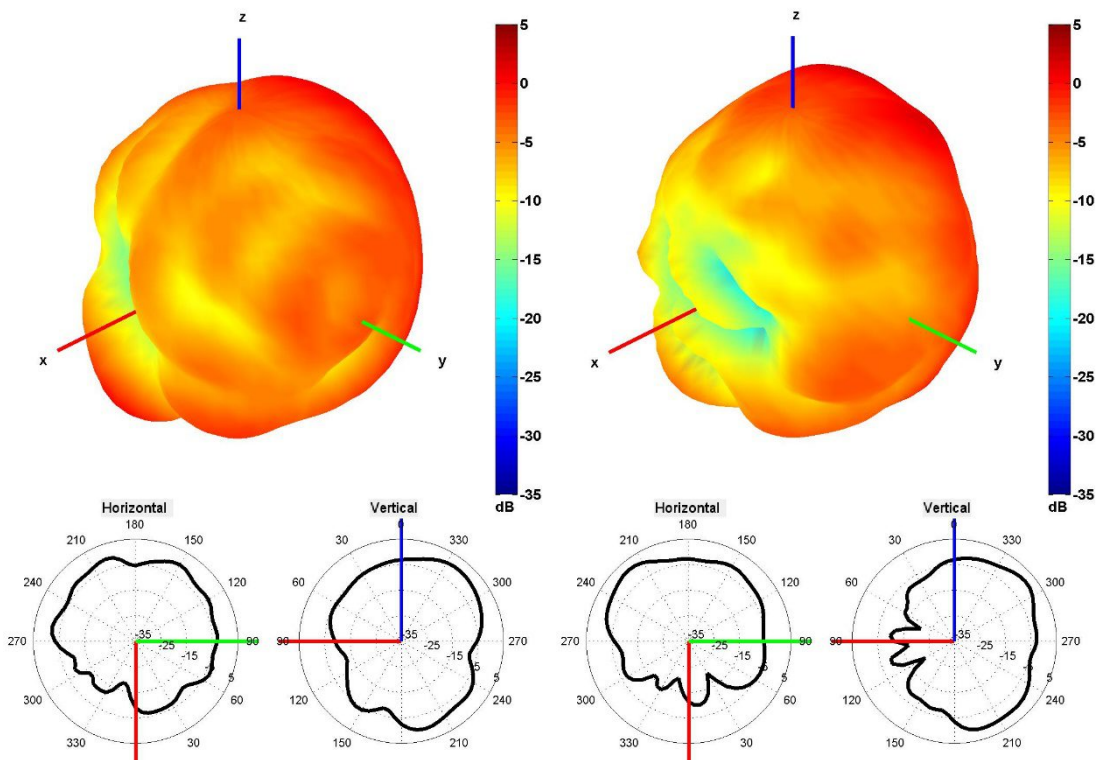


650 and 750 MHz Radiation pattern

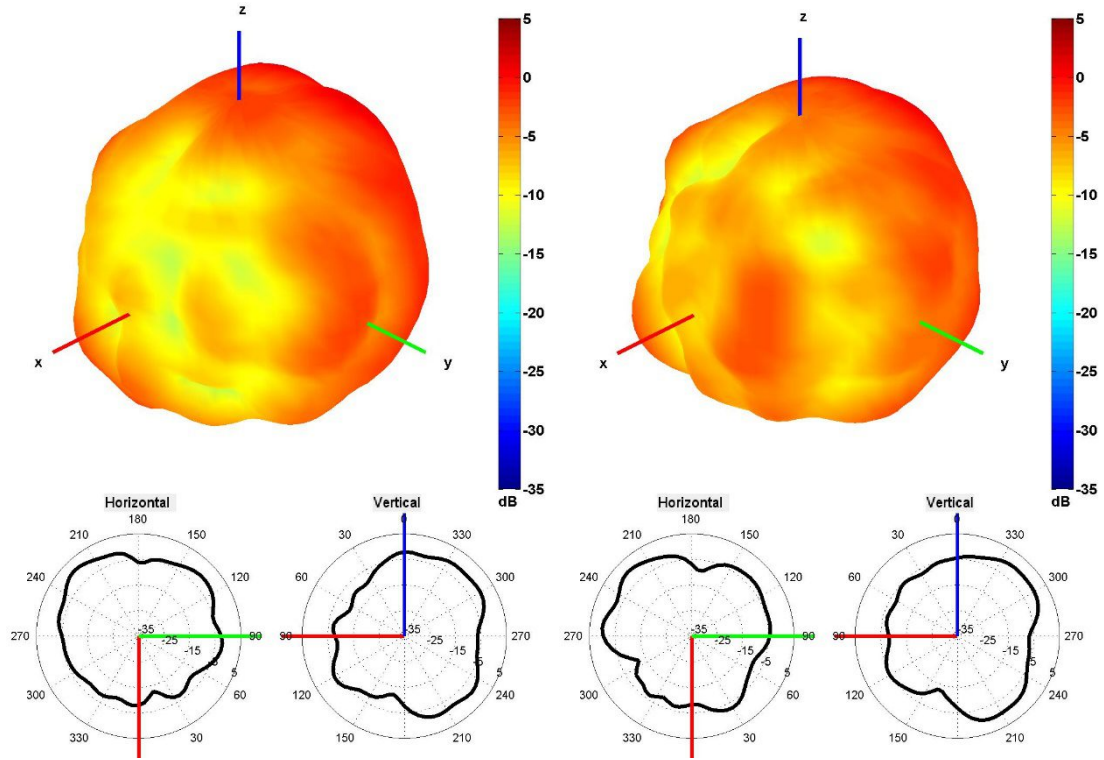




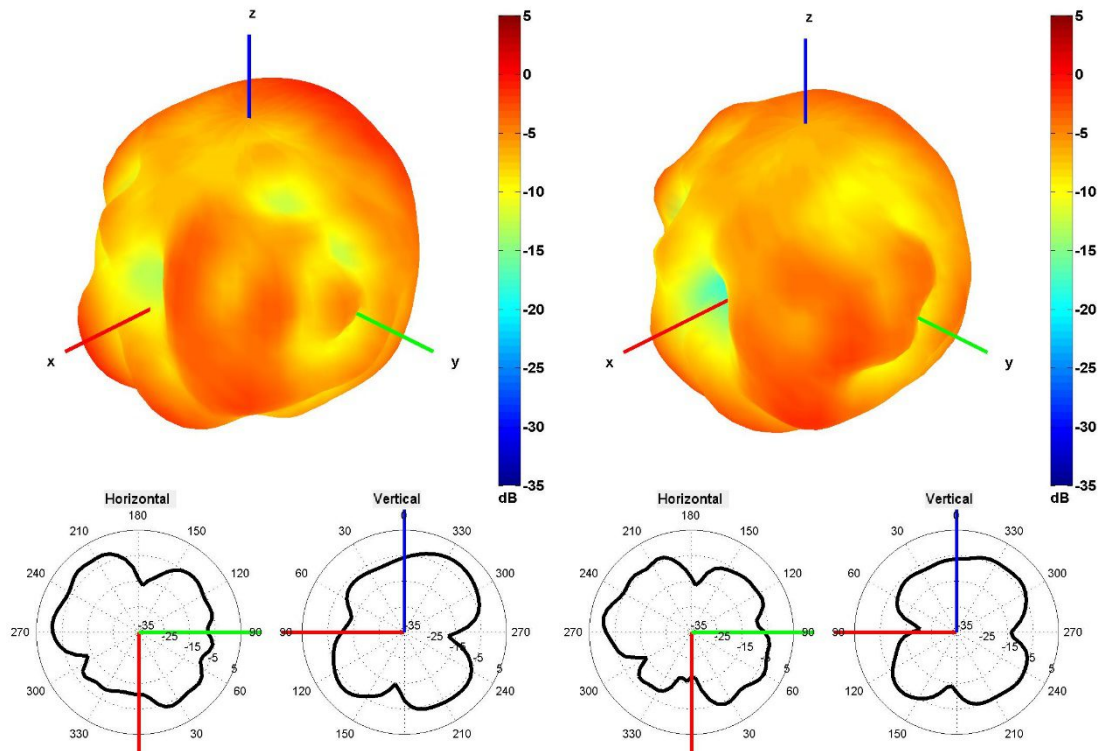
850 and 940 MHz Radiation pattern



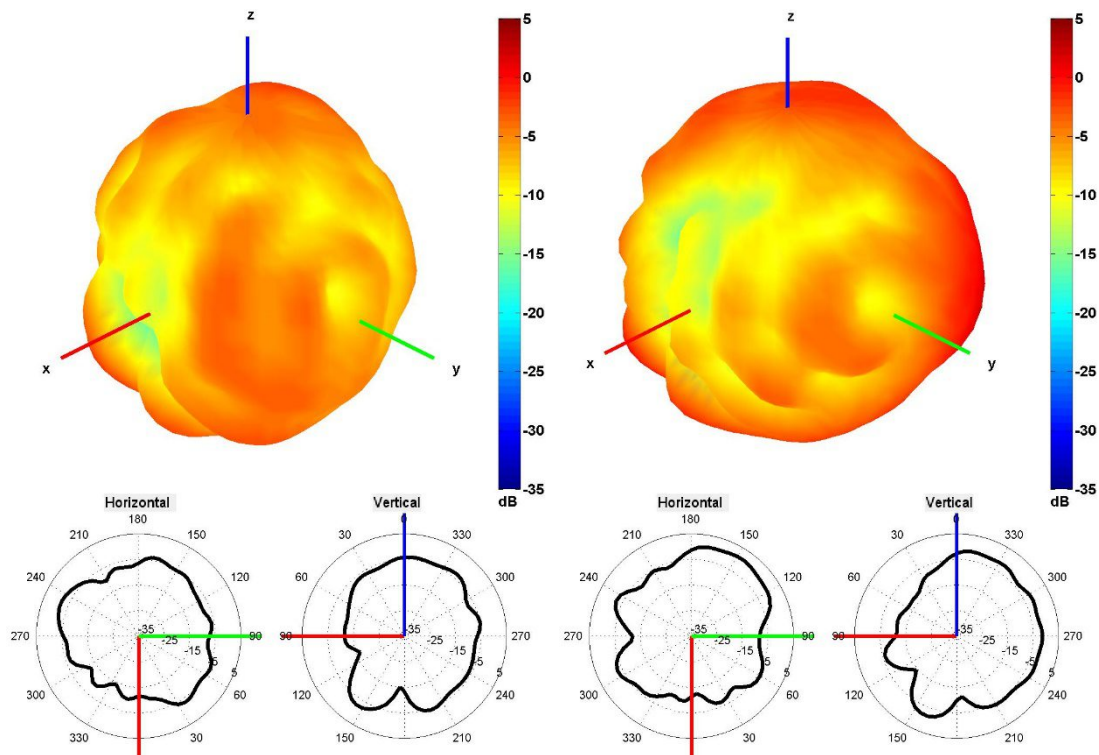
1500 and 1600 MHz Radiation pattern



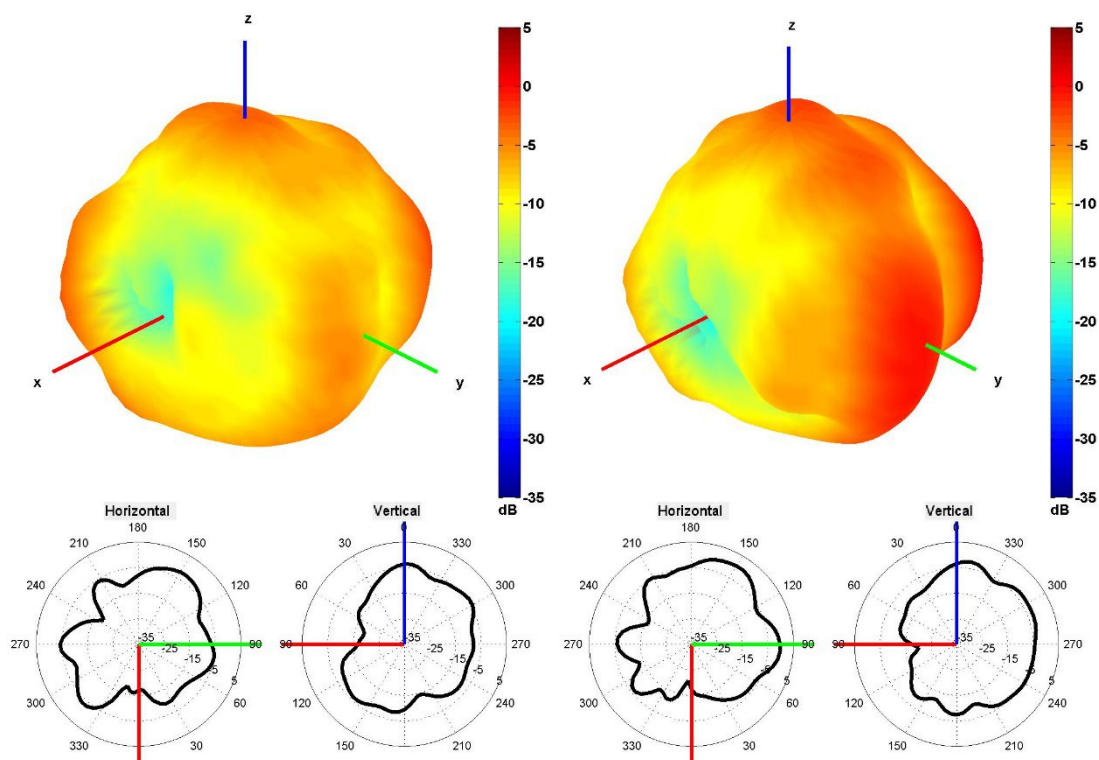
1750 and 1850 MHz Radiation pattern



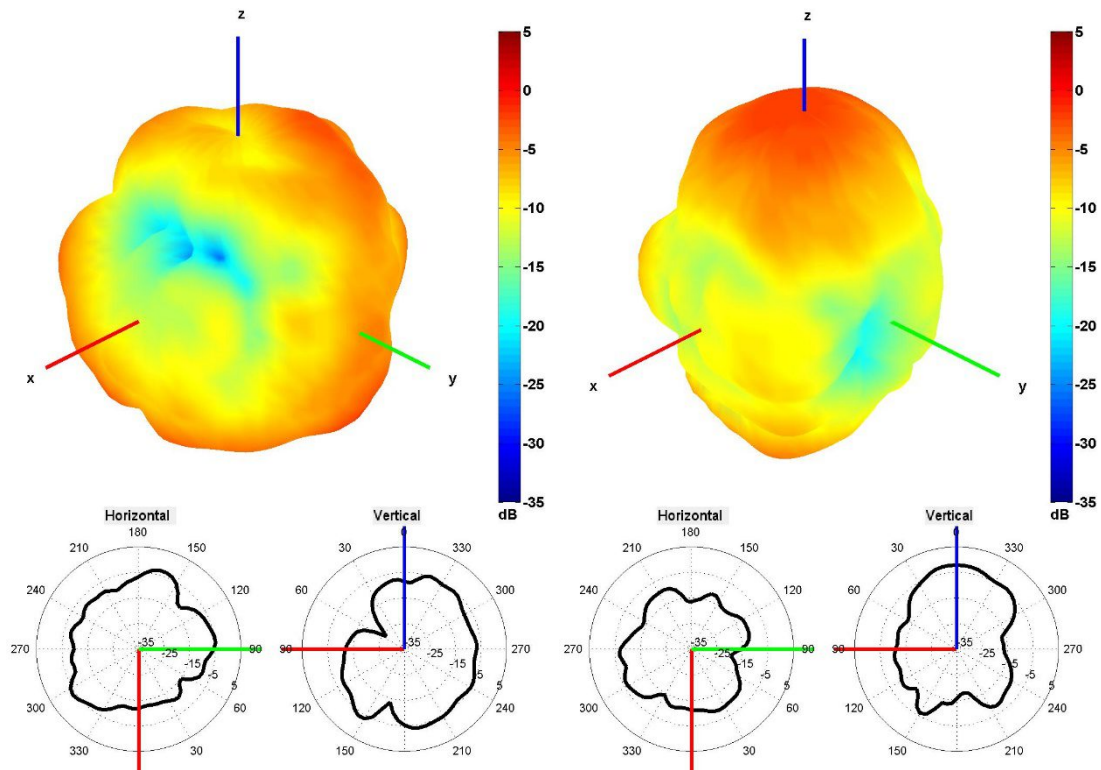
1950 and 2100 MHz Radiation pattern



2350 and 2600 MHz Radiation pattern

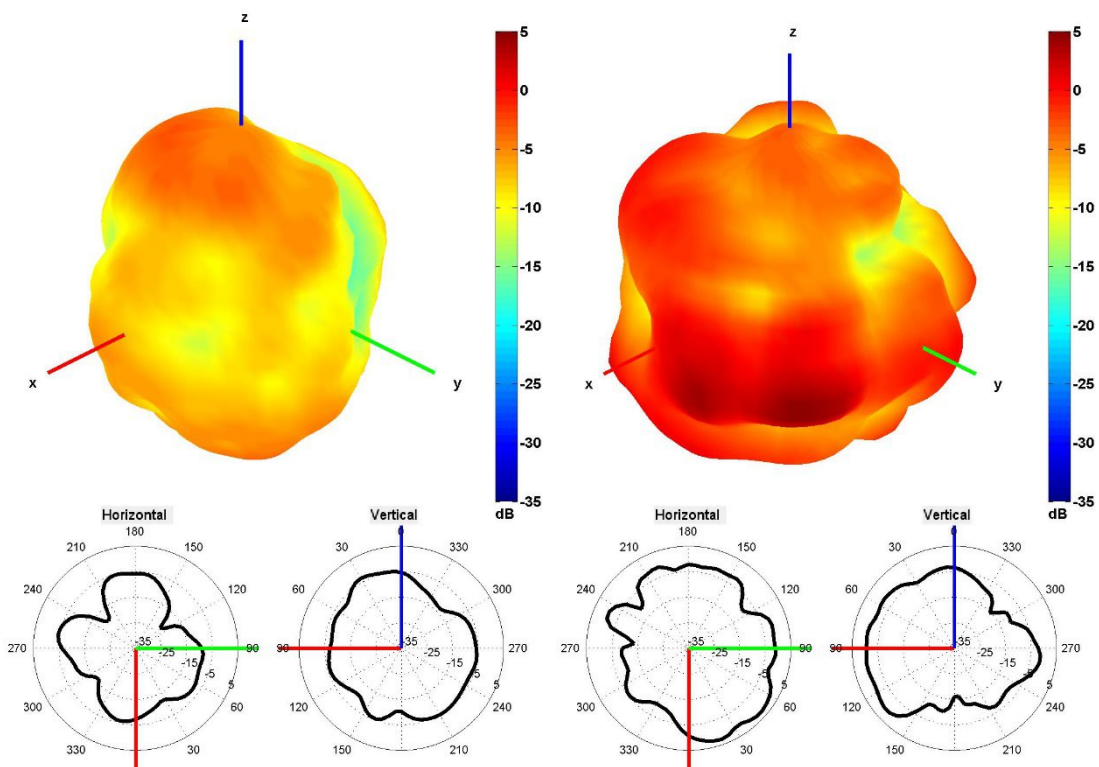


3350 and 3600 MHz Radiation pattern



4500 and 5500 MHz Radiation pattern

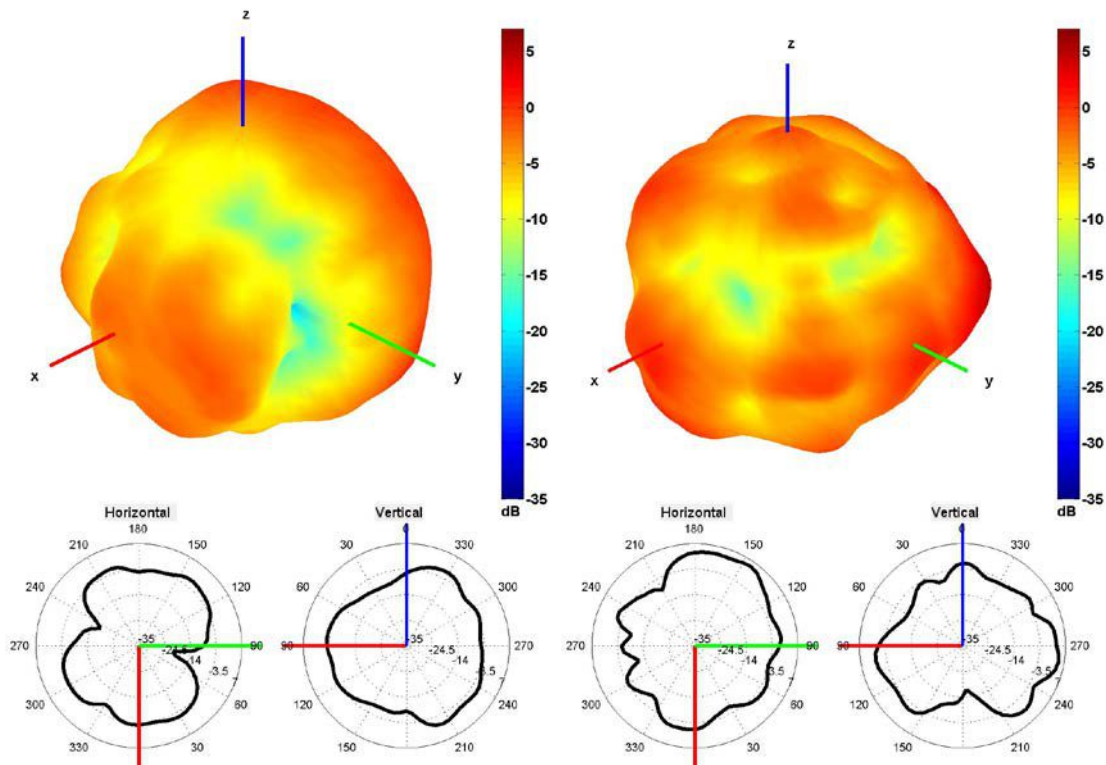
Cable 3: 2.4/5.0 GHz ISM



2450 and 5500 MHz Radiation pattern

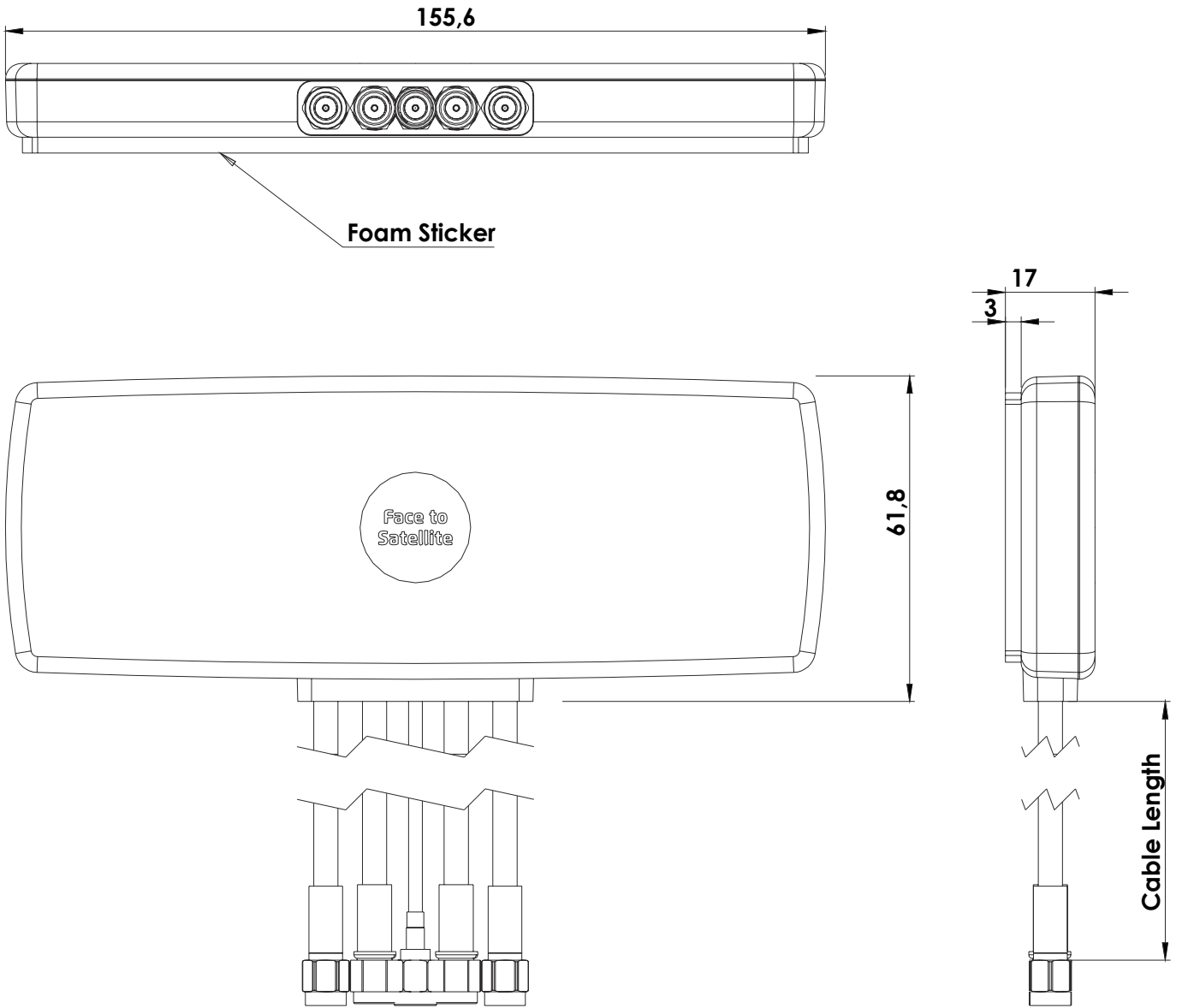


Cable 4: 2.4/5.0 GHz ISM



2450 and 5500 MHz Radiation pattern

#### 4. Antenna drawings



## 5. Antenna Images

