

2J6985Ba

5G NR MIMO and 2.4/5.0/6.0 GHz ISM Screw Mount

Key Features

Cable 1 - 2 : 5G NR

- 617-960 MHz
- 1427-2690 MHz
- 3300-5000 MHz
- 5150-5925 MHz

Cable 3: 2.4/5.0/6.0 GHz ISM

- 2410-2490 MHz
- 4920-5925 MHz
- 5925-7125 MHz

Screw Mount

Anti-Rotation Mounting

Ground Plane Independent

Customizable Cable and Connector

Dimensions 80 × 74 × 25.6 mm

Certificates: IP67, IP69



1. Antenna and electrical specifications

Cable 1

| Parameters | 5GNR Antenna | | | |
|----------------------|---|---|---------------------------------|----------------------|
| Technologies | 5G, 4G, 3G and 2G | | | |
| Standards | 5GNR/4GLTE/FirstNet/CBRS/LPWA/CAT-X/CAT-Mx/CAT-NBx/NB-IoT/3G/2G | | | |
| Frequency (MHz) | 617-960 | 1427-2690 | 3300-5000 | 5150-5925 |
| Band (MHz) | 600, 700, 850, 900 | 1500, 1600, 1700, 1800, 1900, 2000, 2100, 2300, 2500, 2600 | 3300, 3500, 3600, 3700, 4500 | 5200, 5500, 5800 |
| 5GNR Bands | n5, n8, 12, n20, n28, n71, n81, n82, n83, | n1, n2, n3, n7, n25, n34, n38, n39, n40, n41, n50, n51, n66, n70, n74, n75, n76, n80, n84, n86 | n77, n78, n79 | |
| 4GLTE Bands | B5, B6, B8, B12, B13, B14, B17, B18, B19, B20, B26, B27, B28, B29, B44, B67, B68, B71, B85 | B1, B2, B3, B4, B7, B9, B10, B11, B21, B23, B24, B25, B30, B32, B33, B34, B35, B36, B37, B38, B39, B40, B41, B45, B50, B51, B65, B66, B69, B70, B74, B75, B76 | B22, B42, B43, B48, B49, B52 | B46, B47, B252, B255 |
| 3GCELL Bands | B5, B6, B8, B12, B13, B14, B19, B20, B26 | B1, B2, B3, B4, B7, B9, B10, B11, B21, B25, B32, B33, B34, B35, B36, B37, B38, B39, B40 | B22 | |
| 2GCELL Bands | 710, 750, 810T, 850, 900P, 900E, 900R | 1800DCS, 1900PCS | | |
| CDMACELL Bands | BC0, BC2, BC3, BC7, BC9, BC10, BC12, BC18, BC19 | BC1, BC4, BC6, BC8, BC13, BC14, BC15, BC16, BC20, BC21 | | |
| Return Loss (dB) | ~-15.5 | ~-12.1 | ~-12.3 | ~-13.0 |
| VSWR | ~1.5:1 | ~1.8:1 | ~1.9:1 | ~1.7:1 |
| Efficiency (%) | ~35.3 | ~27.1 | ~23.6 | ~22.3 |
| Peak Gain (dBi) | ~3.1 | ~2.7 | ~0.9 | ~0.4 |
| Average Gain (dB) | ~-4.6 | ~-5.4 | ~-6.5 | ~-6.5 |
| Impedance (Ohm) | 50 | | | |
| Polarisation | Linear | | | |
| Radiation Pattern | Omni-Directional | | | |
| Max. Input Power (W) | 25 | | | |
| Connector Type | SMA-Male Standard (Other Connectors Available) | | | |
| Cable Length | 300 cm Standard (Any Cable Length Available) | | | |
| Cable Type | D302 Standard (Other Cables Available) | | | |

Cable 2

| Parameters | 5GNR Antenna | | | |
|-----------------------------|---|---|---------------------------------|----------------------|
| Technologies | 5G, 4G, 3G and 2G | | | |
| Standards | 5GNR/4GLTE/FirstNet/CBRS/LPWA/CAT-X/CAT-Mx/CAT-NBx/NB-IoT/3G/2G | | | |
| Frequency (MHz) | 617-960 | 1427-2690 | 3300-5000 | 5150-5925 |
| Band (MHz) | 600, 700, 850, 900 | 1500, 1600, 1700, 1800, 1900, 2000, 2100, 2300, 2500, 2600 | 3300, 3500, 3600, 3700, 4500 | 5200, 5500, 5800 |
| 5GNR Bands | n5, n8 ,12, n20, n28, n71, n81, n82, n83, | n1, n2, n3, n7, n25, n34, n38, n39, n40, n41, n50, n51, n66, n70, n74, n75, n76, n80, n84, n86 | n77, n78, n79 | |
| 4GLTE Bands | B5, B6, B8, B12, B13, B14, B17, B18, B19, B20, B26, B27, B28, B29, B44, B67, B68, B71, B85 | B1, B2, B3, B4, B7, B9, B10, B11, B21, B23, B24, B25, B30, B32, B33, B34, B35, B36, B37, B38, B39, B40, B41, B45, B50, B51, B65, B66, B69, B70, B74, B75, B76 | B22, B42, B43, B48, B49, B52 | B46, B47, B252, B255 |
| 3GCELL Bands | B5, B6, B8, B12, B13, B14, B19, B20, B26 | B1, B2, B3, B4, B7, B9, B10, B11, B21, B25, B32, B33, B34, B35, B36, B37, B38, B39, B40 | B22 | |
| 2GCELL Bands | 710, 750, 810T, 850, 900P, 900E, 900R | 1800DCS, 1900PCS | | |
| CDMACELL Bands | BC0, BC2, BC3, BC7, BC9, BC10, BC12, BC18, BC19 | BC1, BC4, BC6, BC8, BC13, BC14, BC15, BC16, BC20, BC21 | | |
| Return Loss (dB) | ~-16.8 | ~-12.8 | ~-13.4 | ~-13.1 |
| VSWR | ~1.4:1 | ~1.7:1 | ~1.7:1 | ~1.7:1 |
| Efficiency (%) | ~34.1 | ~27.3 | ~20.0 | ~22.0 |
| Peak Gain (dBi) | ~3.2 | ~2.9 | ~1.2 | ~0.4 |
| Average Gain (dB) | ~-4.8 | ~-5.7 | ~-7.3 | ~-6.6 |
| Impedance (Ohm) | 50 | | | |
| Polarisation | Linear | | | |
| Radiation Pattern | Omni-Directional | | | |
| Max. Input Power (W) | 25 | | | |
| Connector Type | SMA-Male Standard (Other Connectors Available) | | | |
| Cable Length | 300 cm Standard (Any Cable Length Available) | | | |
| Cable Type | D302 Standard (Other Cables Available) | | | |

Antenna Measurement Conditions:

Mounted on Metal Plate of 30 x 30 cm
 100 cm of Cable D302
 Measured in Certified CTIA 3D Anechoic Chamber

Cable 3

| Parameters | 2.4/5.0/6.0 GHz ISM Antenna | | |
|-----------------------------|--|-----------|-----------|
| Standards | WiFi, BT, ZigBee, ISM | | |
| Band (MHz) | 2.4 GHz | 5.0 GHz | 6.0 GHz |
| Frequency (MHz) | 2410-2490 | 4920-5925 | 5925-7125 |
| Return Loss (dB) | ~-11.4 | ~-18.0 | ~-18.5 |
| VSWR | ~2.0:1 | ~1.3:1 | ~1.3:1 |
| Efficiency (%) | ~24.7 | ~27.4 | ~25.4 |
| Peak Gain (dBi) | ~-0.2 | ~1.7 | ~1.6 |
| Average Gain (dB) | ~-6.1 | ~-5.6 | ~-5.8 |
| Impedance (Ohm) | 50 | | |
| Polarisation | Linear | | |
| Radiation Pattern | Omni-Directional | | |
| Max. Input Power (W) | 25 | | |
| Connector Type | SMA-Male Standard (Other Connectors Available) | | |
| Cable Length | 300 cm Standard (Any Cable Length Available) | | |
| Cable Type | D302 Standard (Other Cables Available) | | |

2. Mechanical and environmental specifications

| Specifications | 2J6985Ba |
|----------------------------------|----------------|
| Mounting Type | Screw Mount |
| Dimensions (mm) | 80 × 74 × 25.6 |
| Max. Tighten Torque (Nm) | 5 Nm |
| Radome Type | PC+ASA |
| Radome Color | Black, White |
| Operating Temperature (C) | -40 to +85 |
| Storage Temperature (C) | -40 to +85 |
| Substance Compliance | RoHS |
| Certificates | IP67, IP69 |

3. Antenna parameters

Cable 1: 5GNR

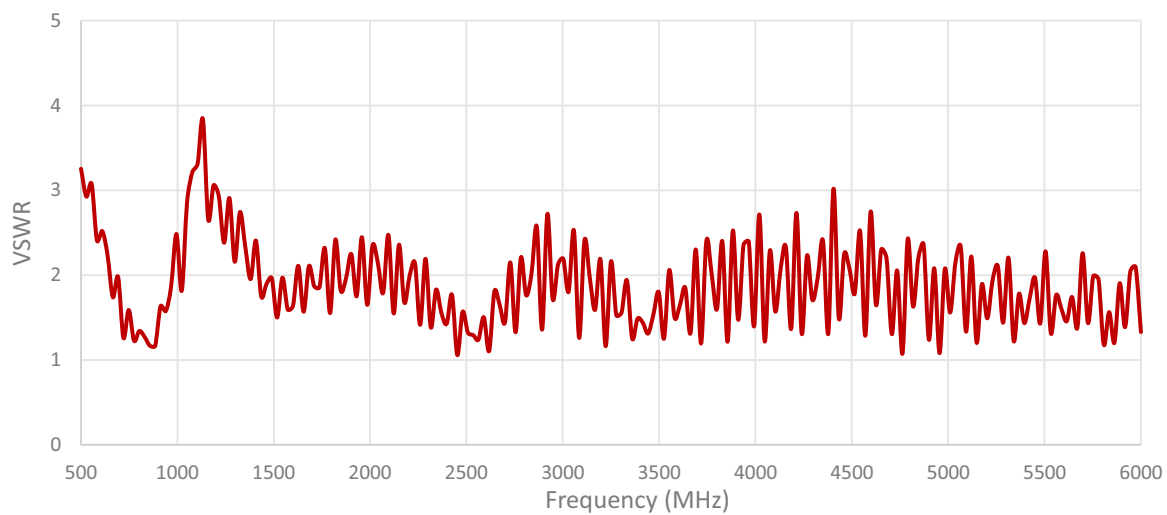
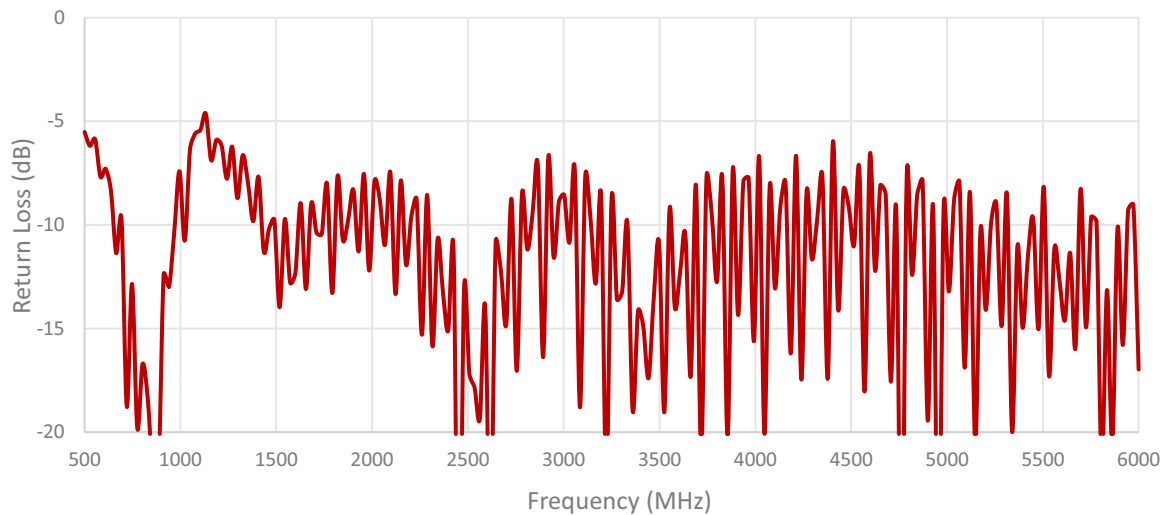

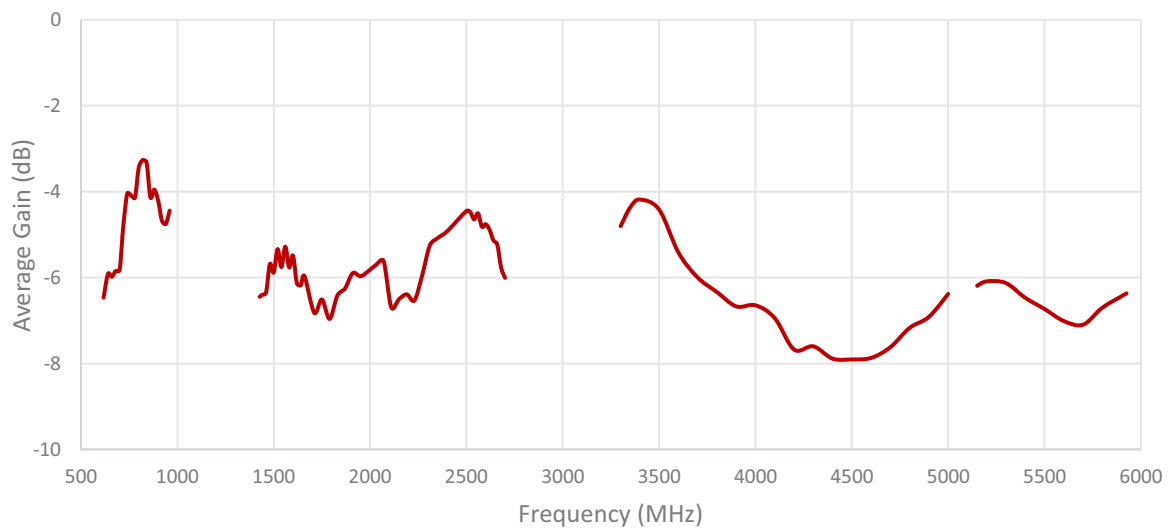
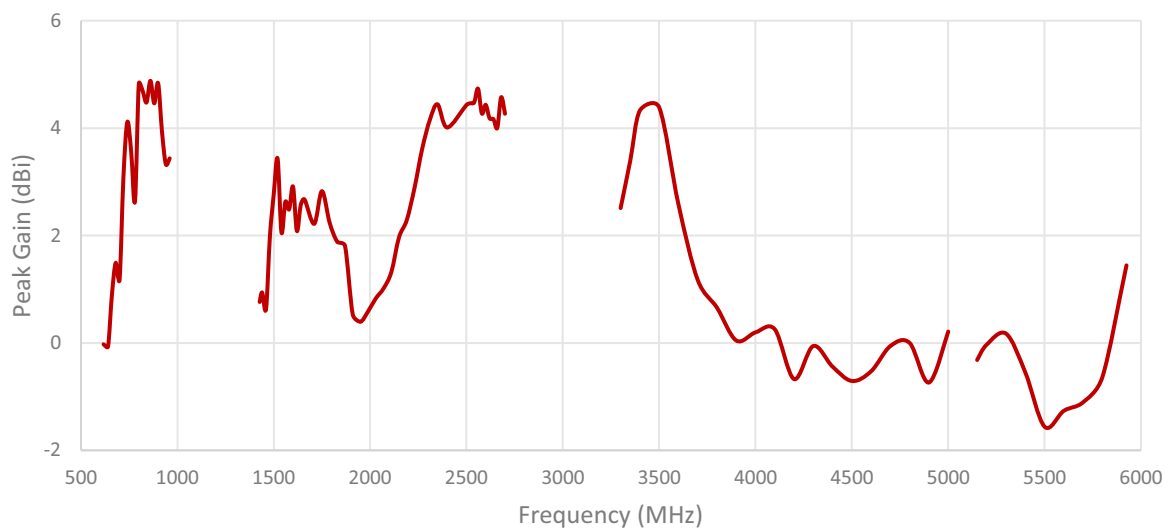
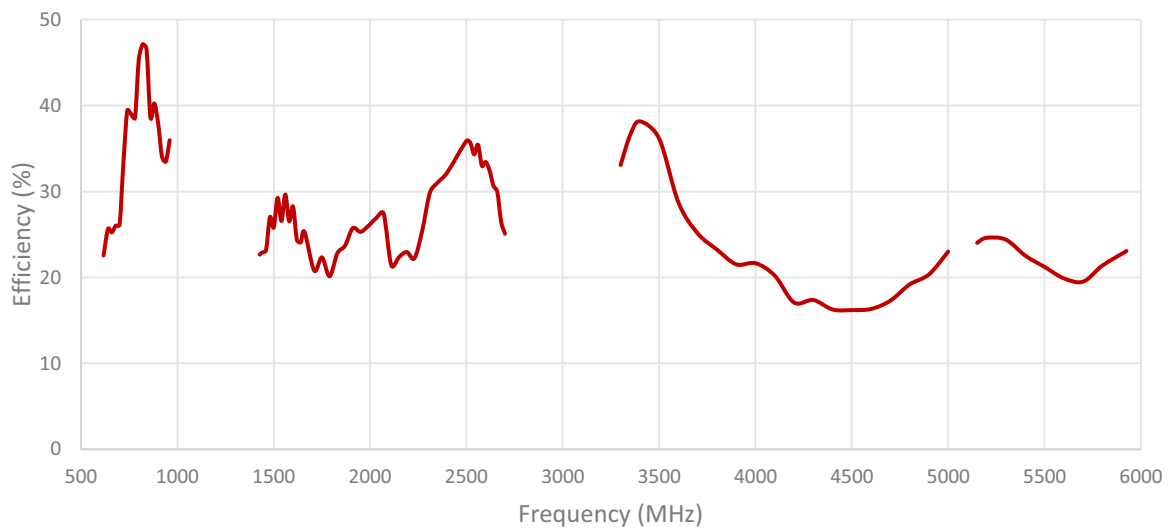

Cable 2: 5GNR

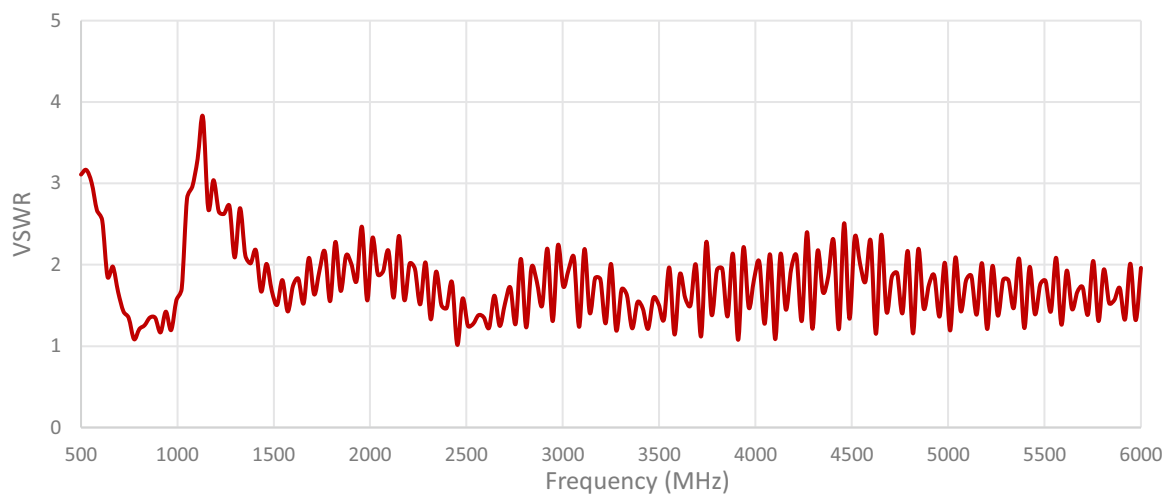
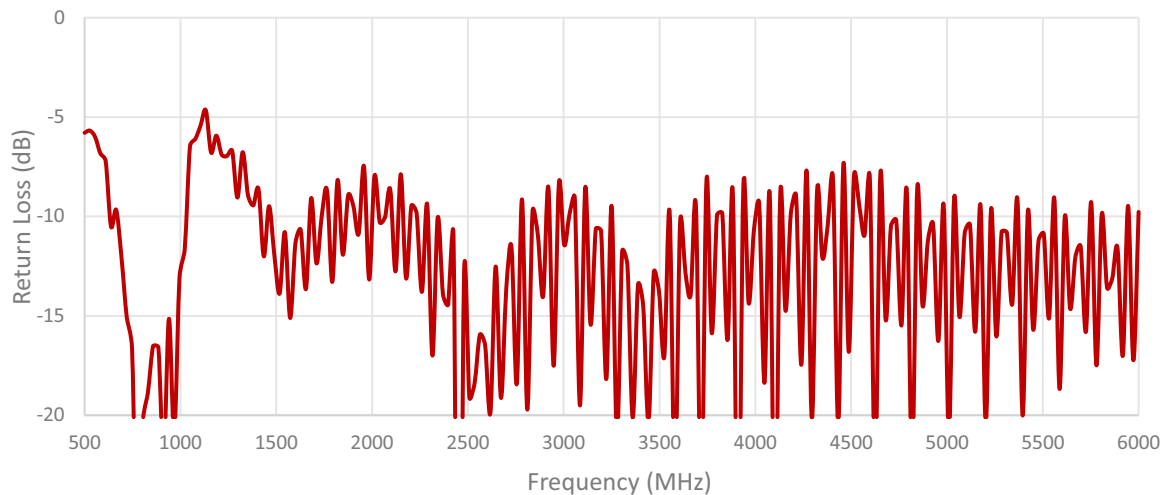

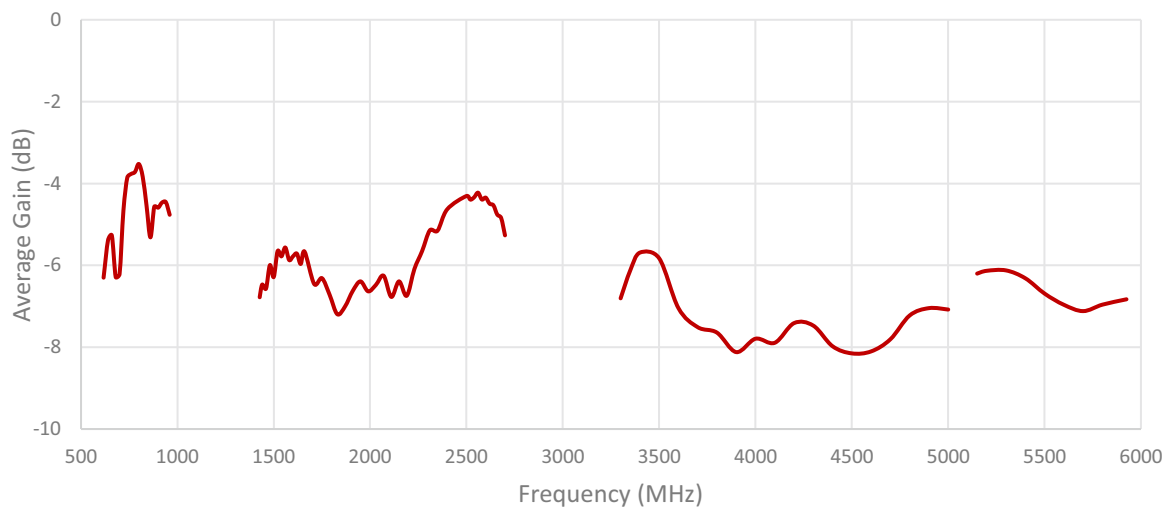
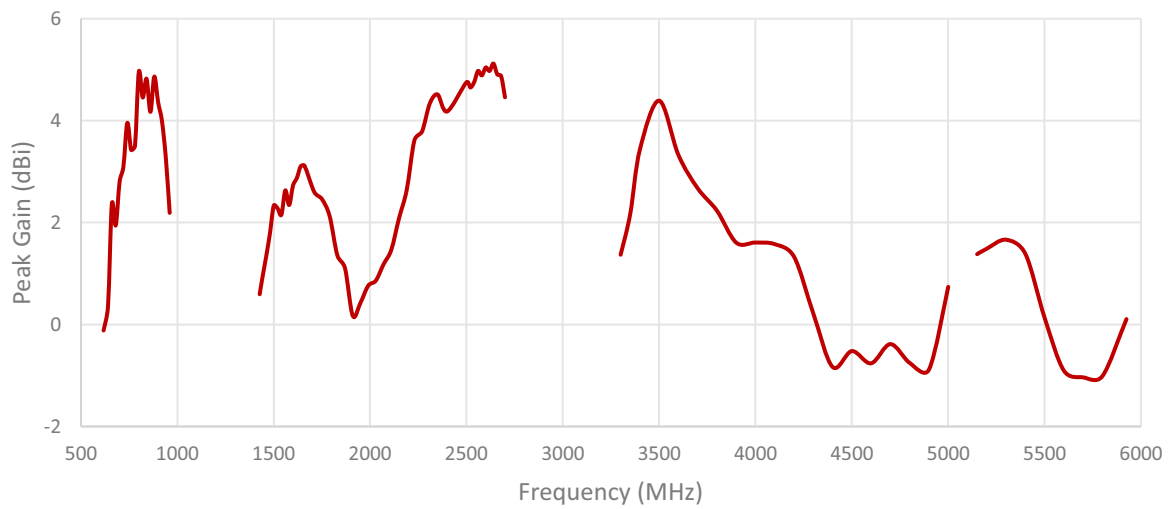
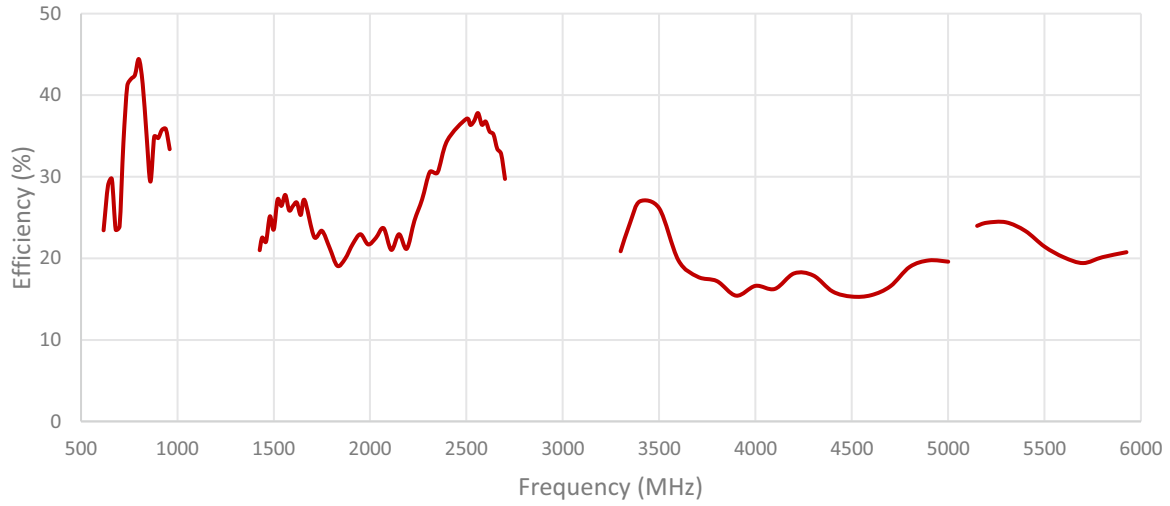

Cable 3: WIFI-6-6E

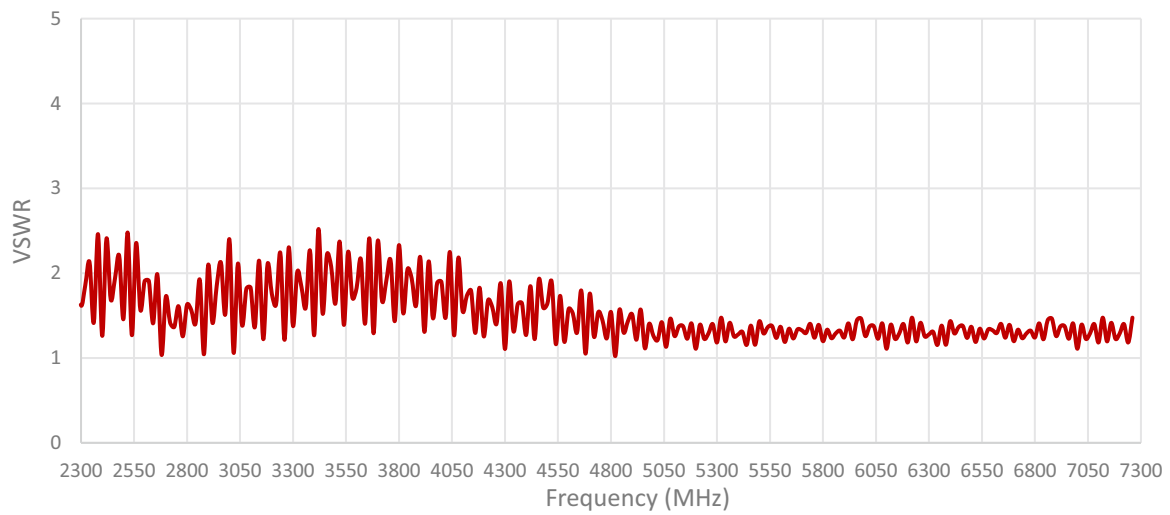
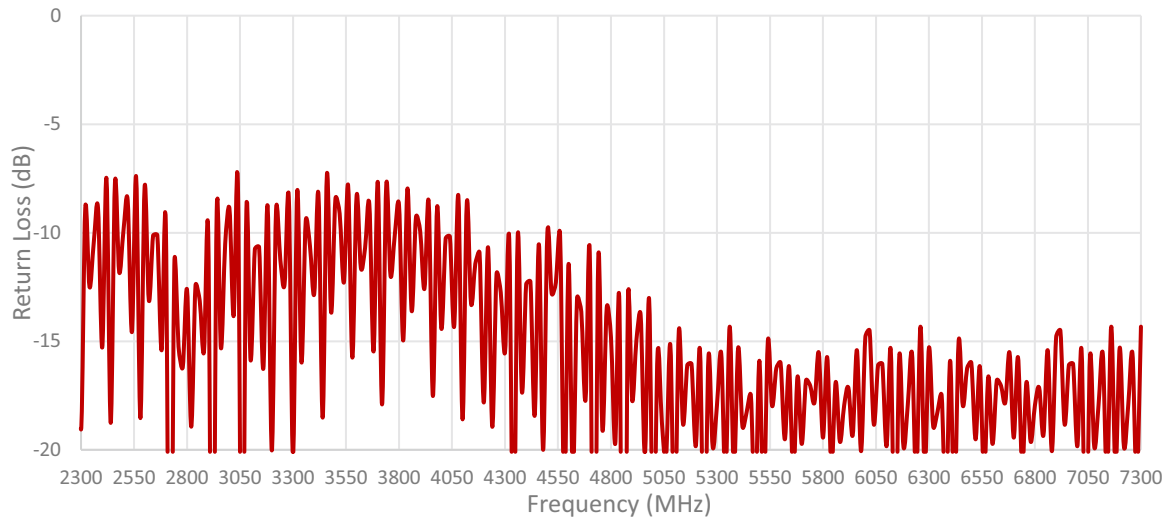

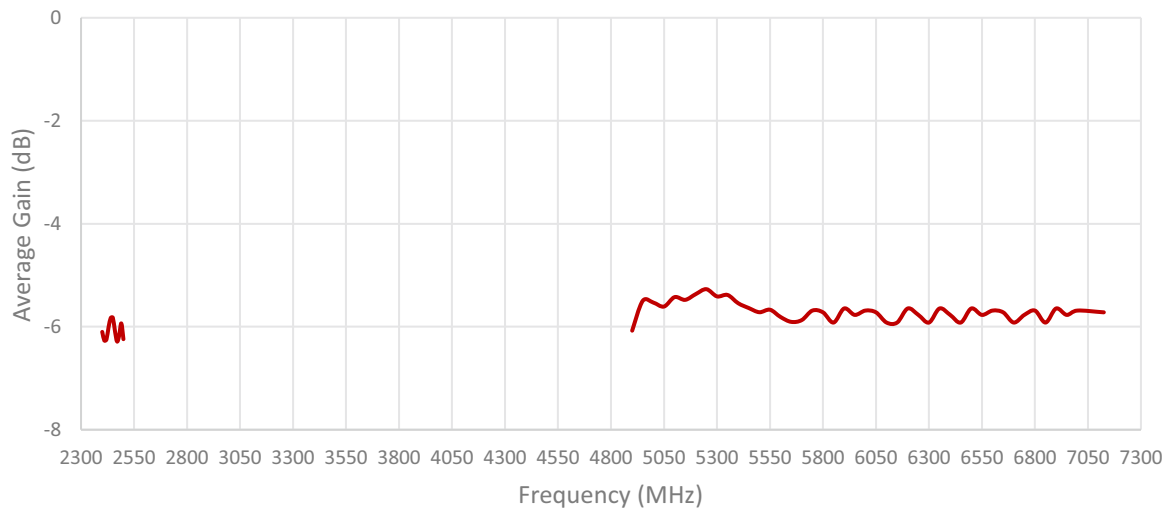
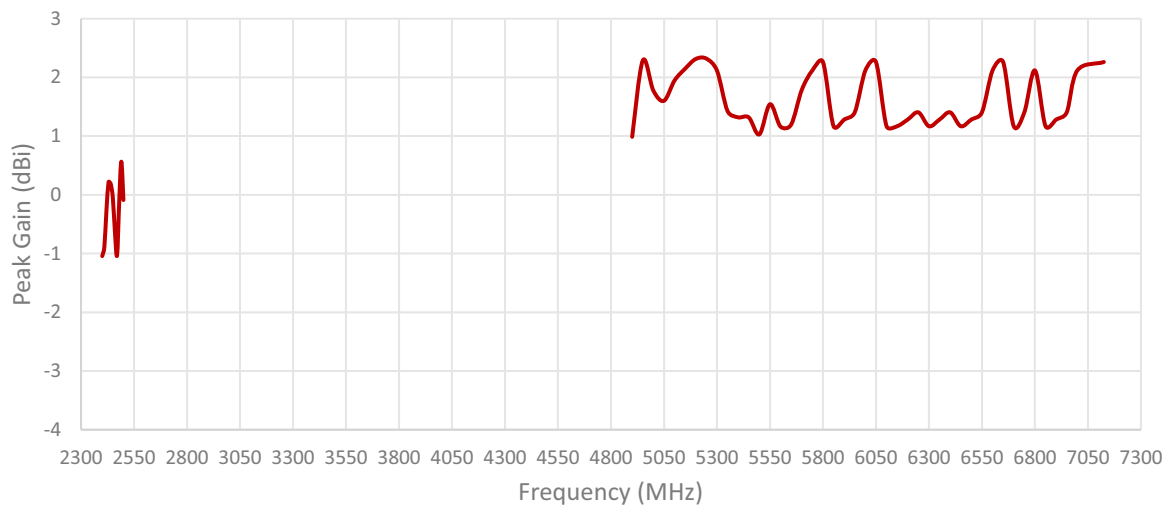
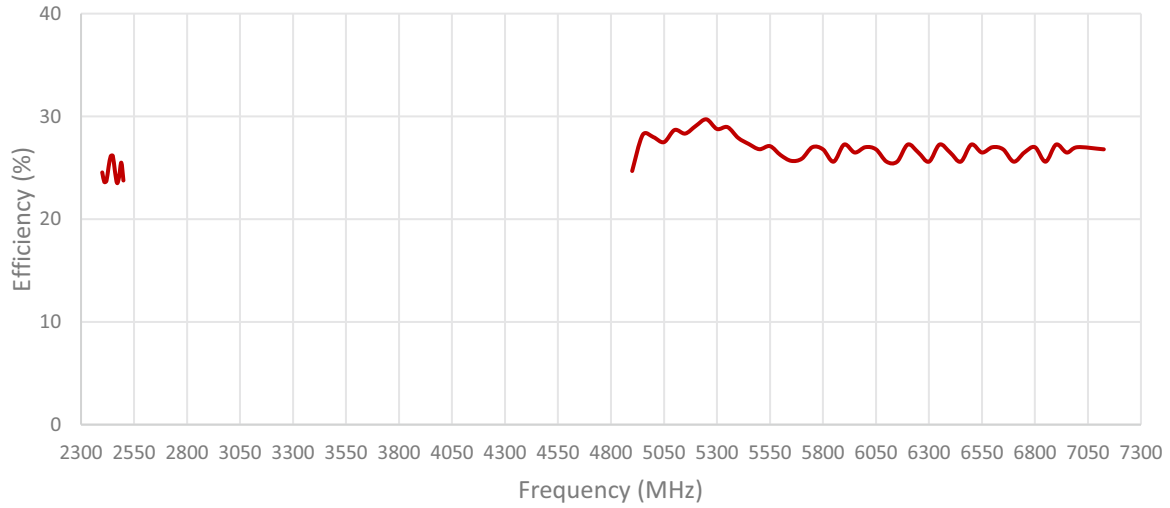

ISOLATION FOR CABLES 1 AND 2

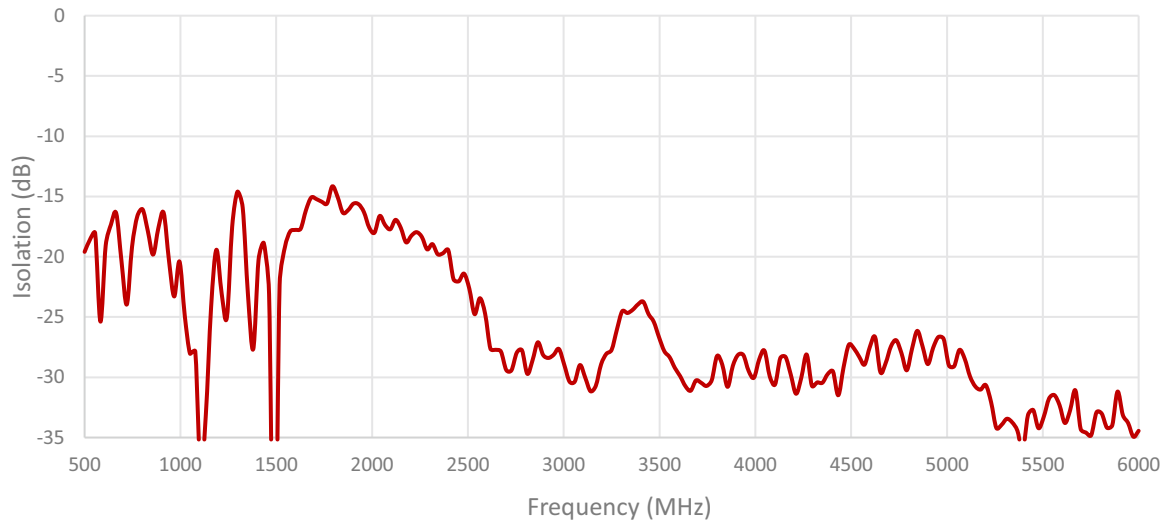

ENVELOPE CORRELATION COEFFICIENT FOR CABLES 1 AND 2

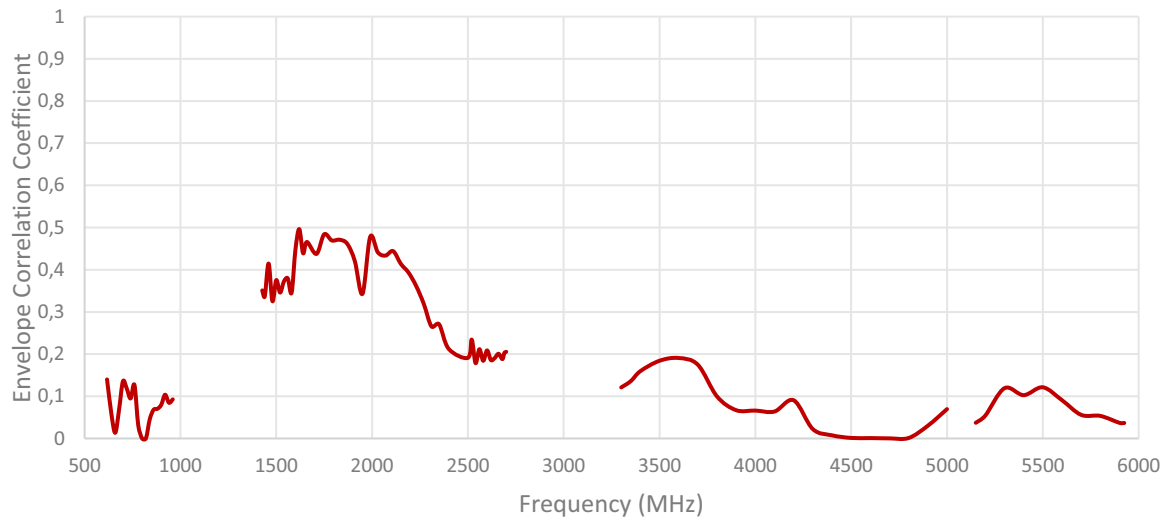

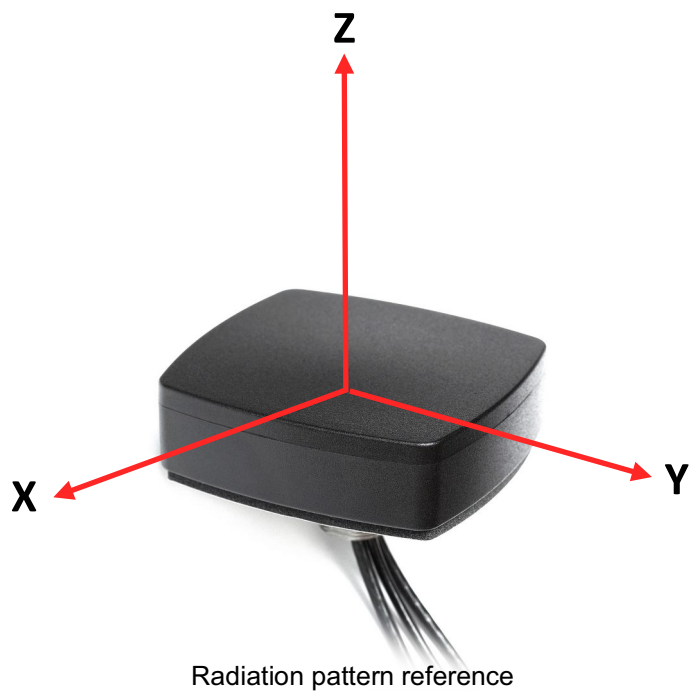

Cable 1: 5GNR

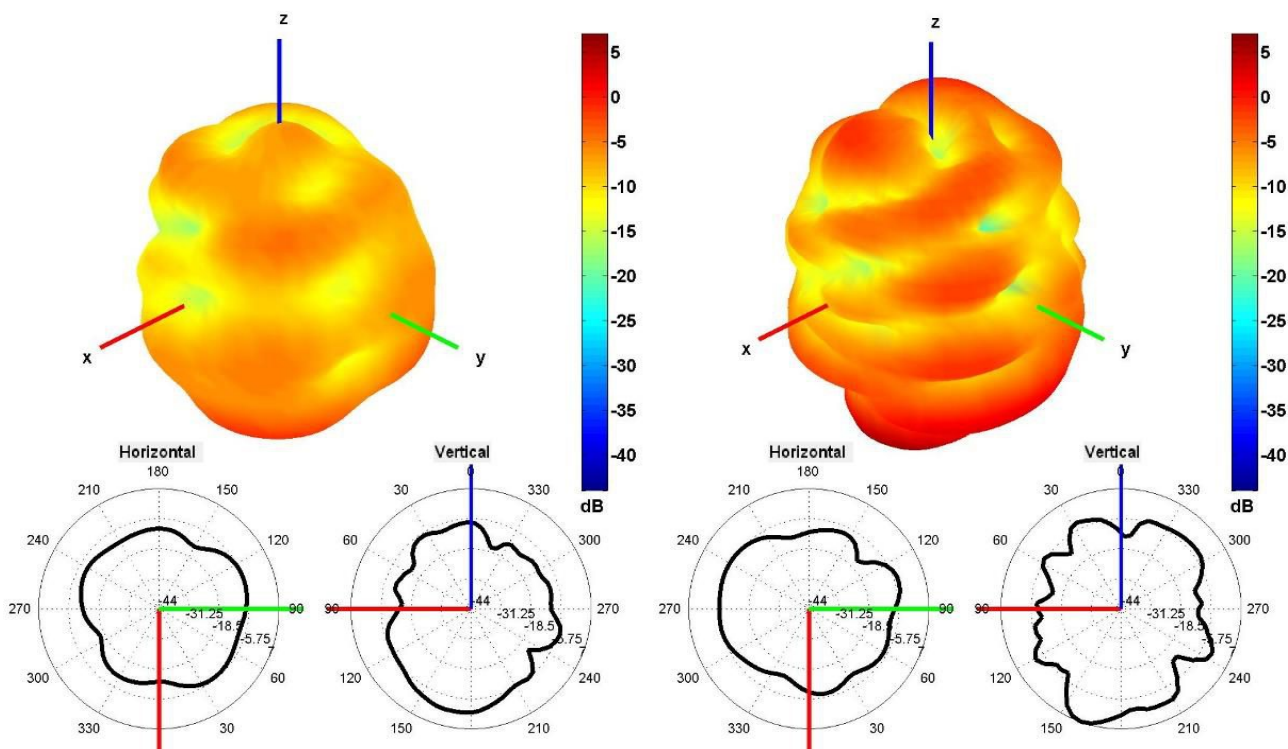

640 and 740 MHz Radiation pattern

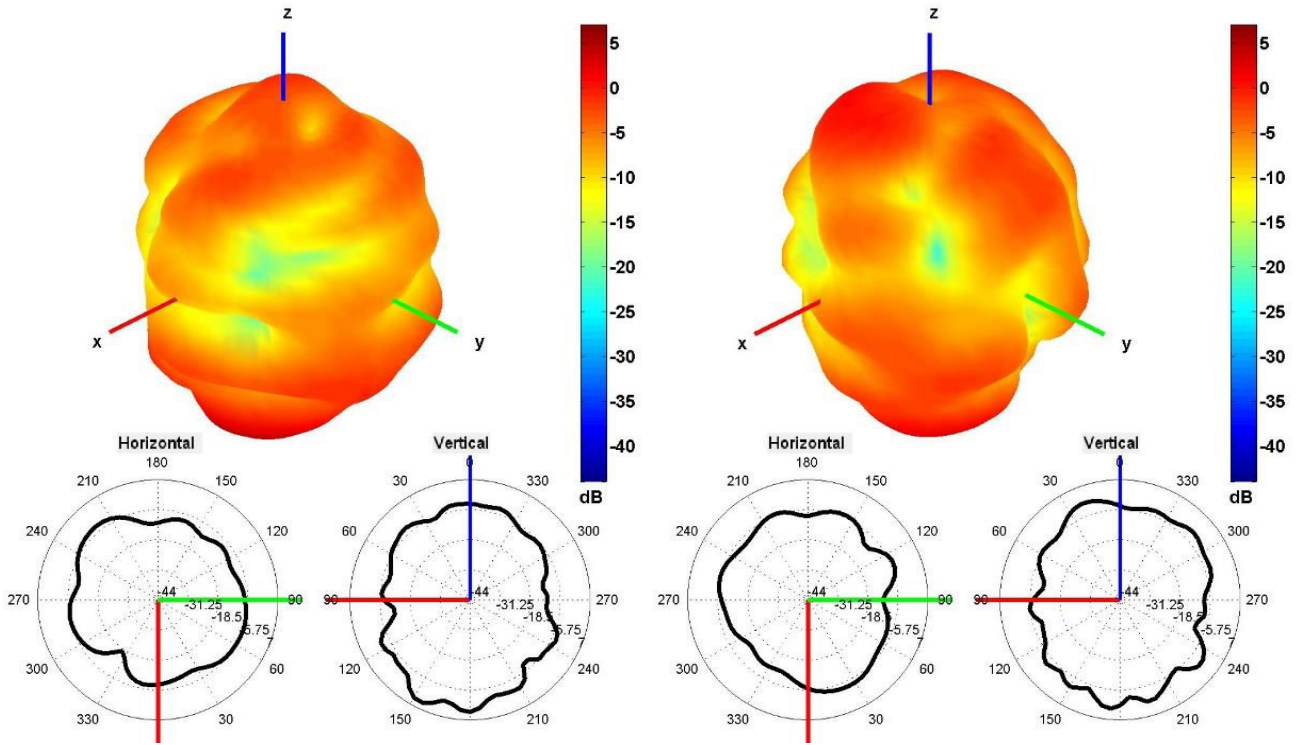

850 and 940 MHz Radiation pattern

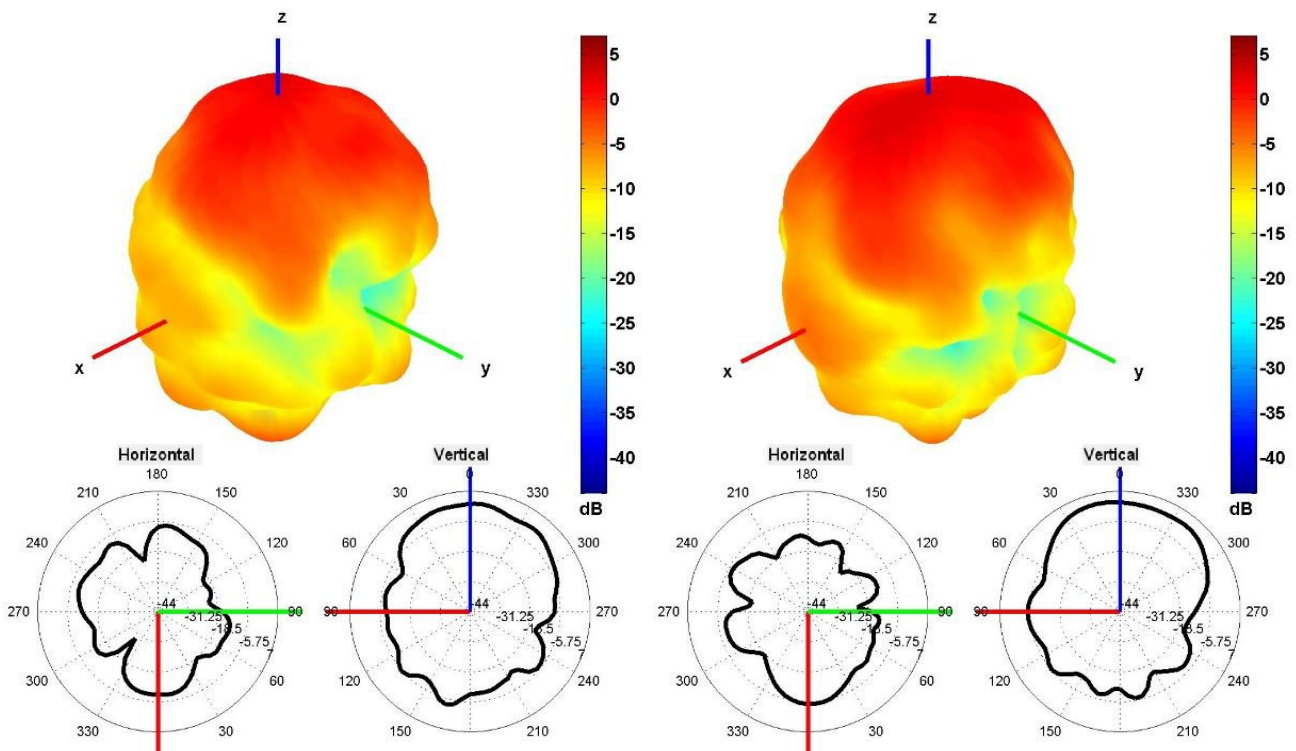

1500 and 1600 MHz Radiation pattern

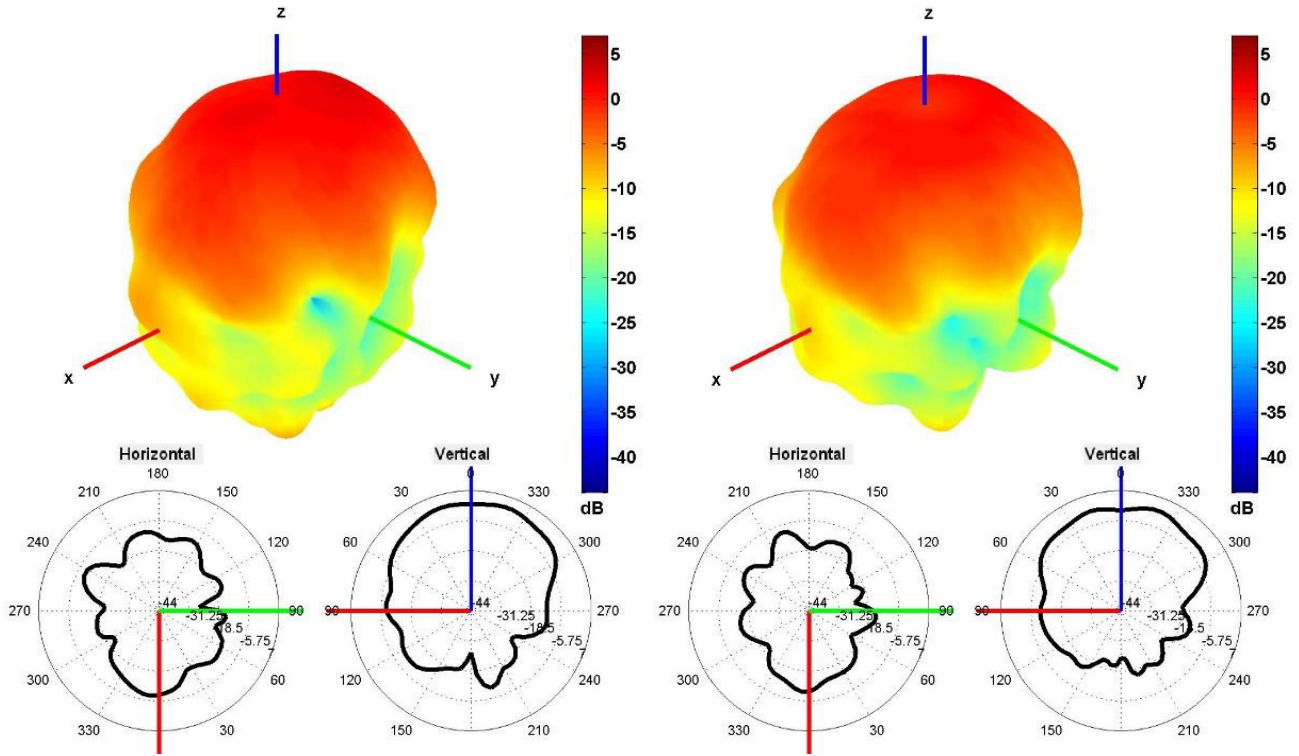

1750 and 1850 MHz Radiation pattern

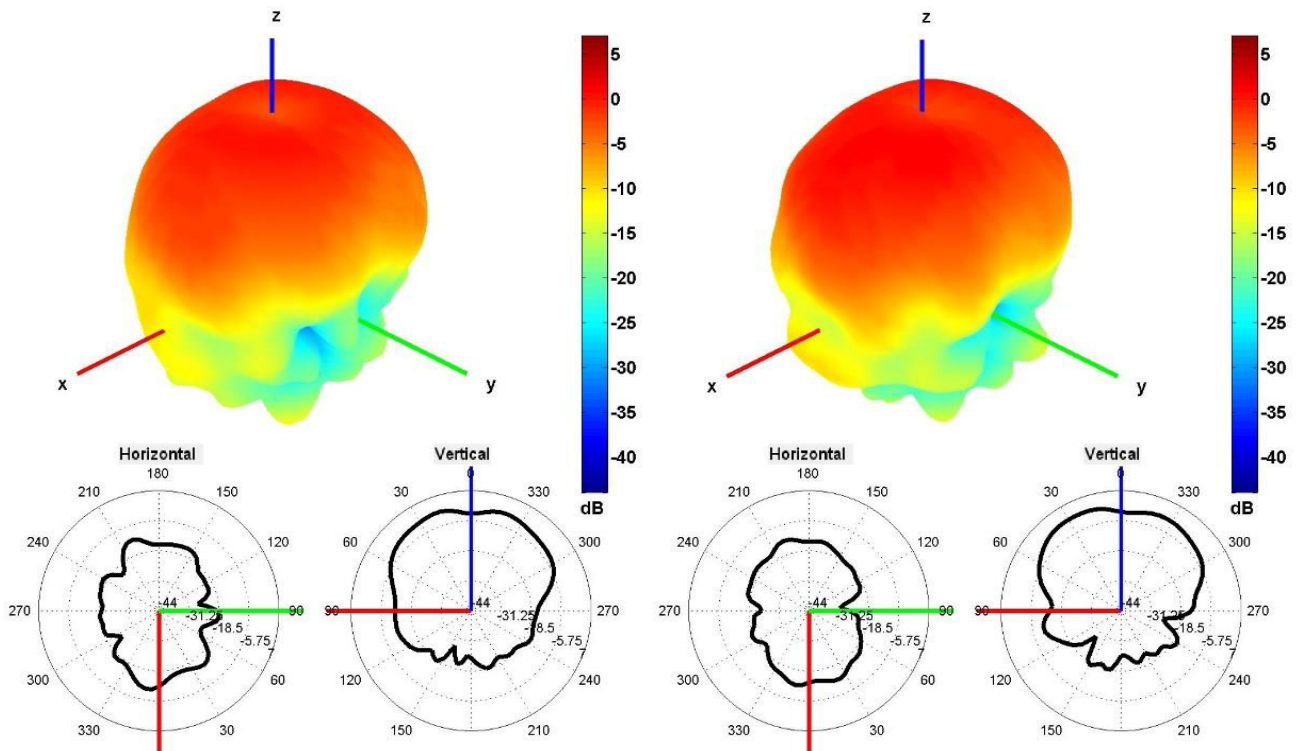

1950 and 2100 MHz Radiation pattern

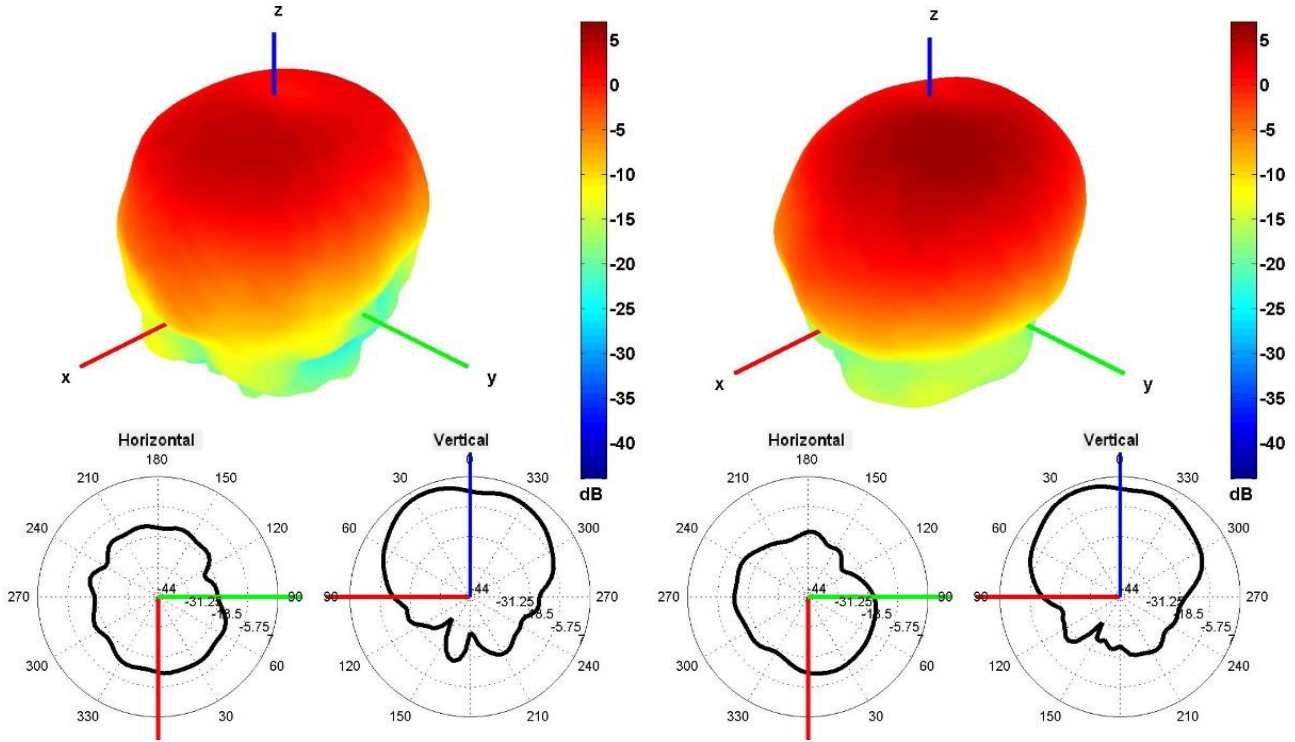

2350 and 2600 MHz Radiation pattern

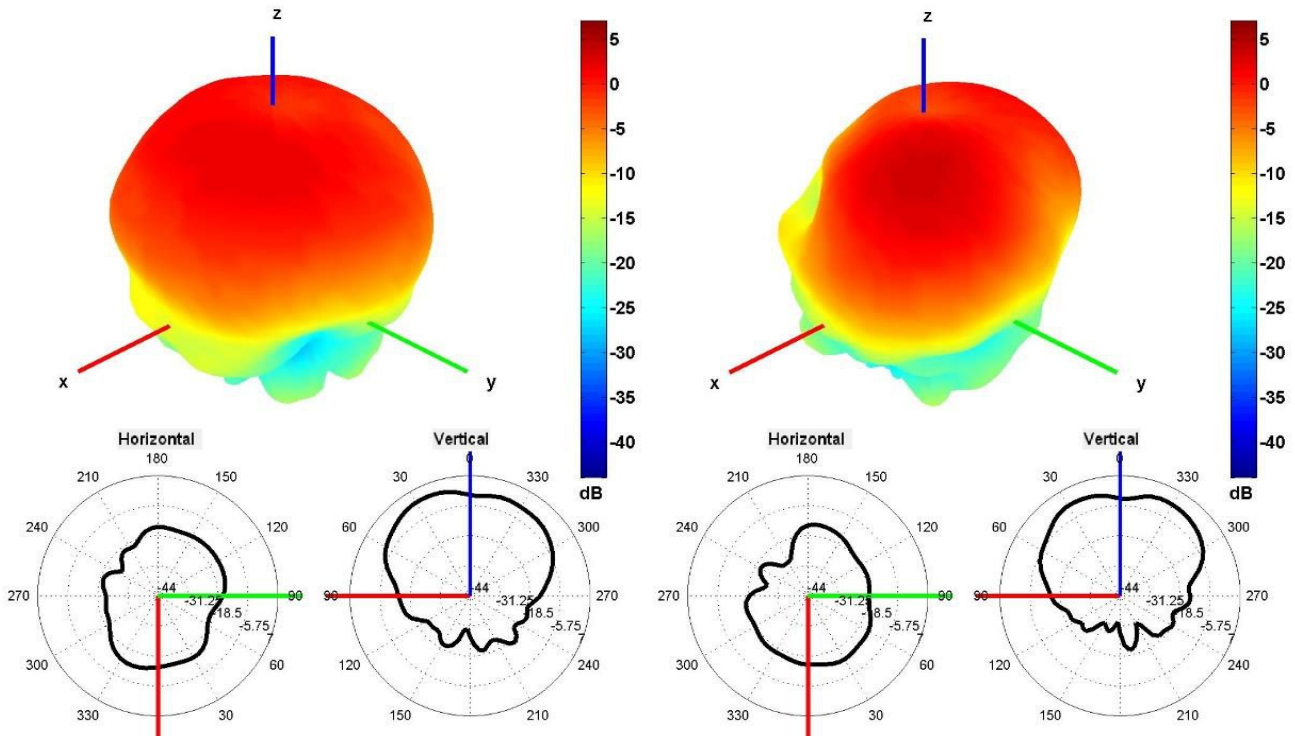

3350 and 3600 MHz Radiation pattern

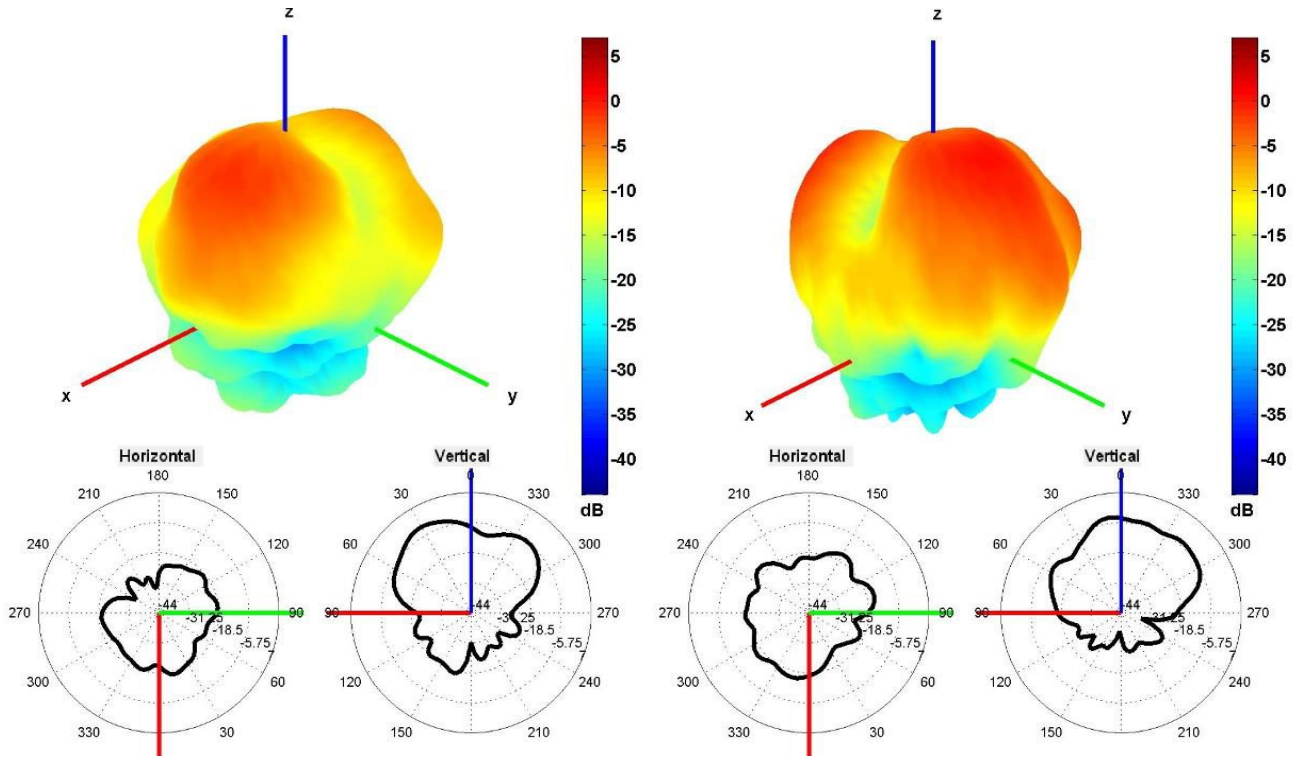

4500 and 5500 MHz Radiation pattern

Cable 2: 5GNR

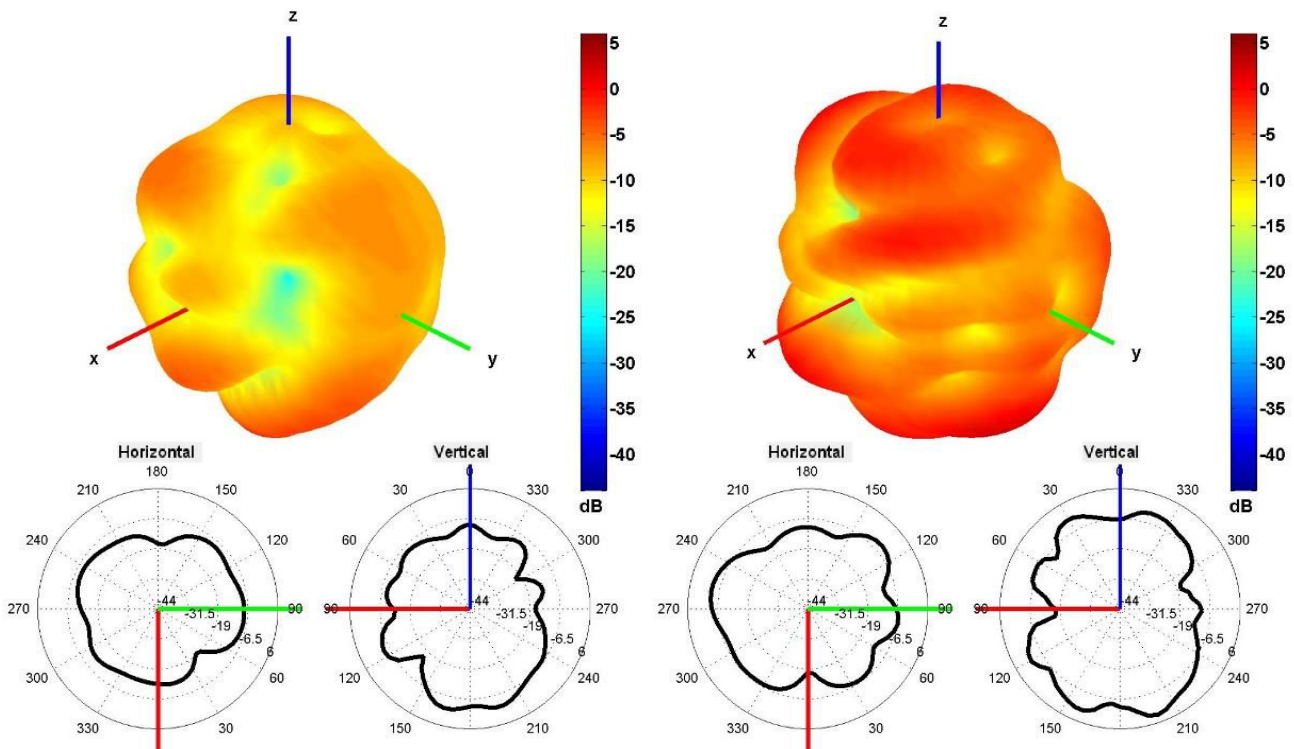

640 and 740 MHz Radiation pattern

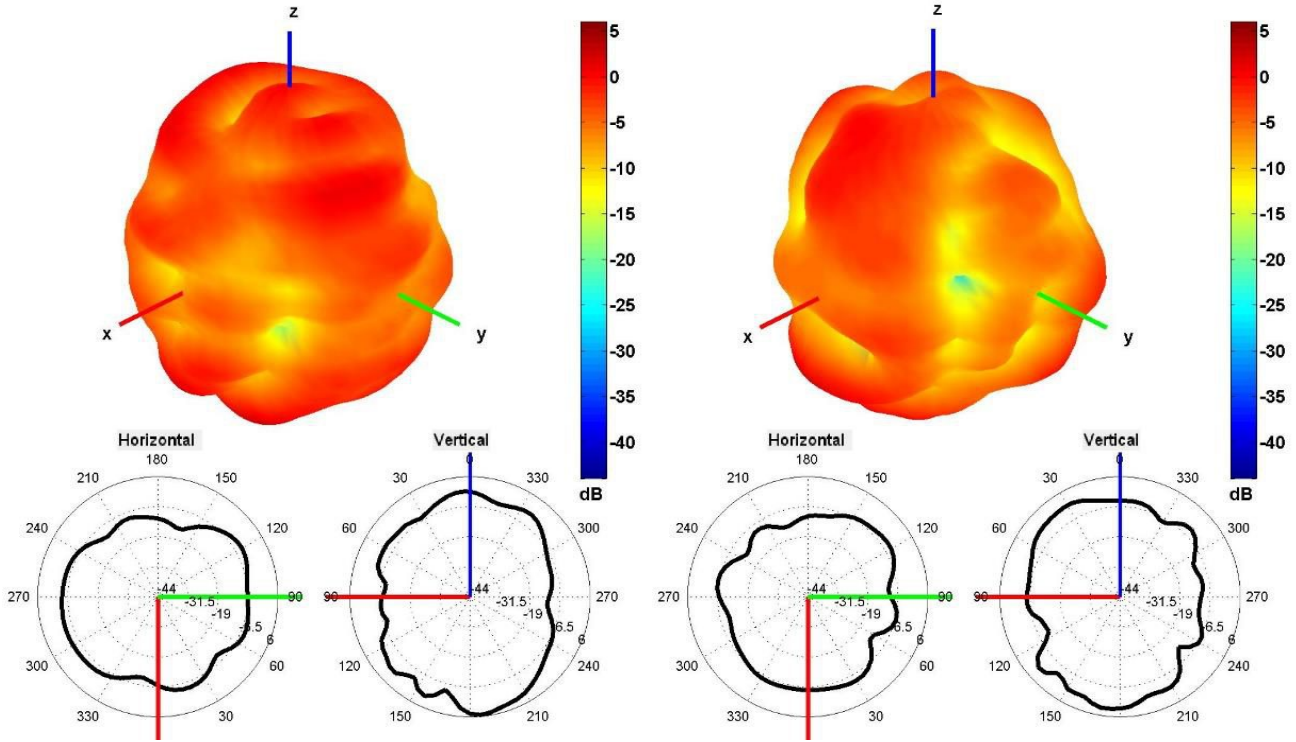

850 and 940 MHz Radiation pattern

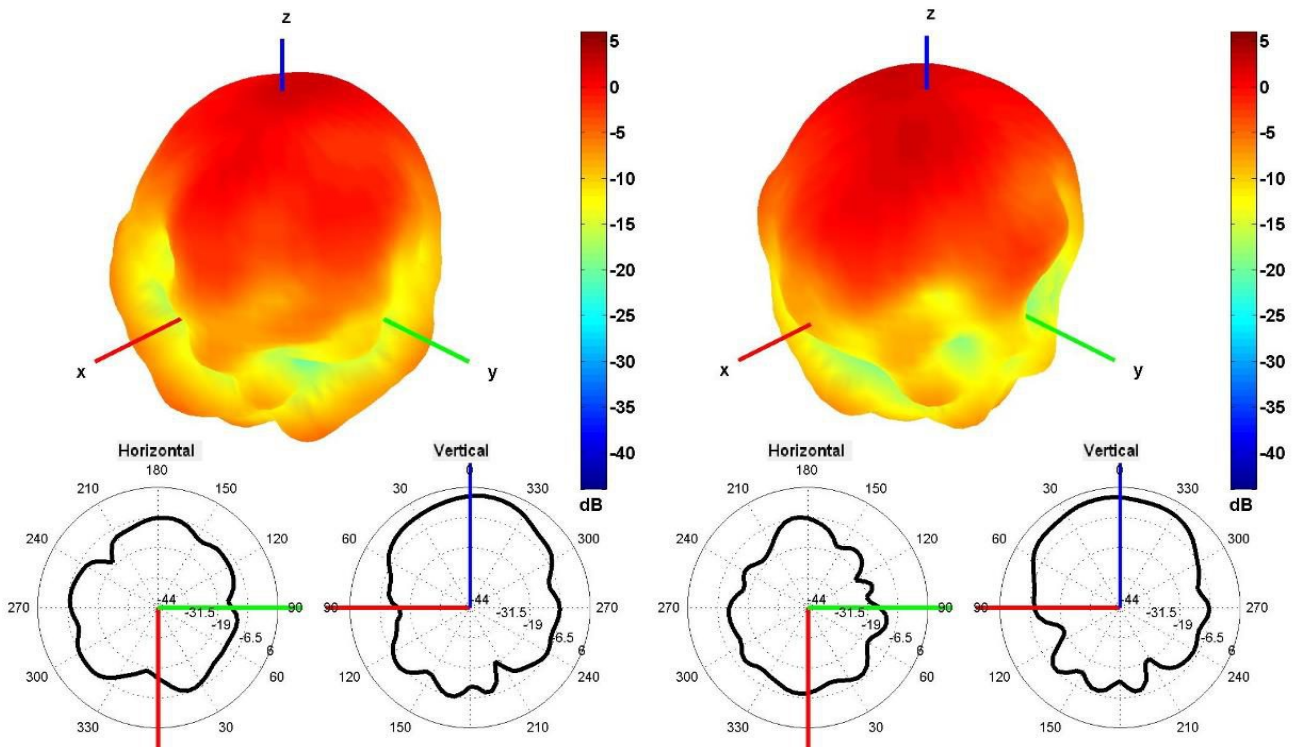

1500 and 1600 MHz Radiation pattern

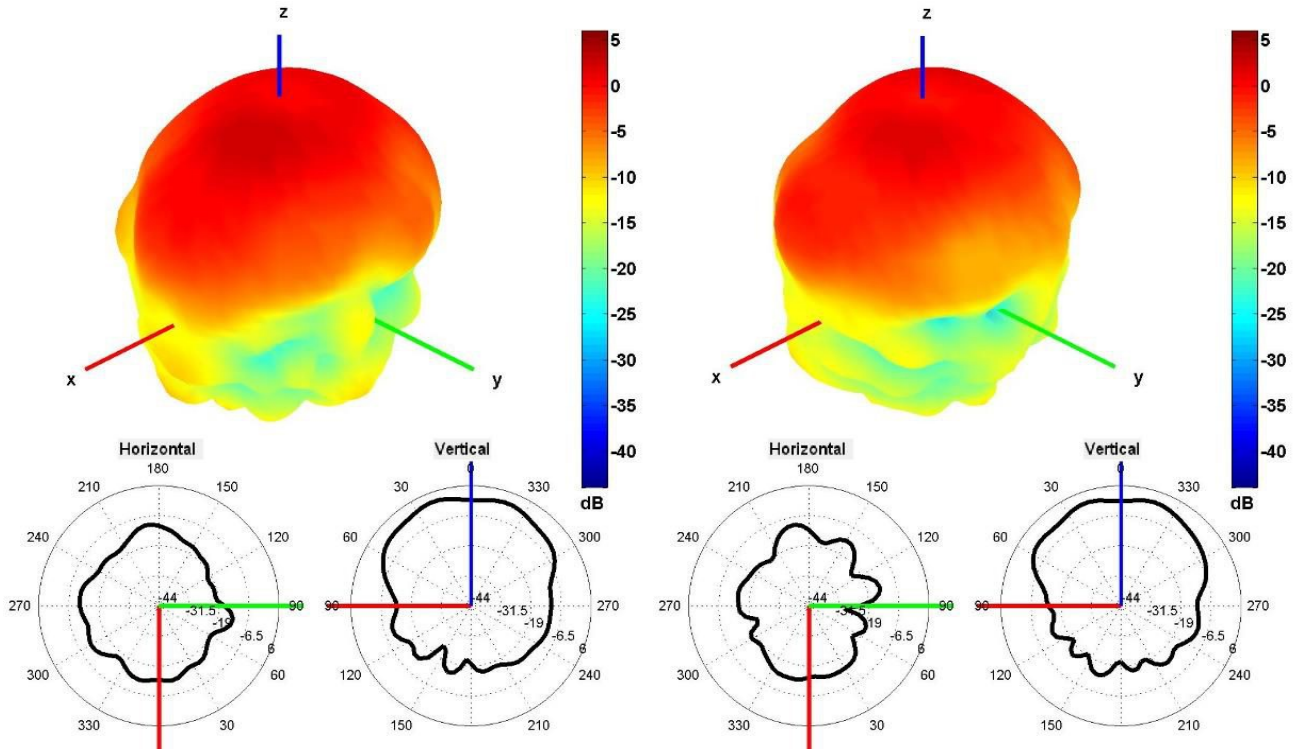

1750 and 1850 MHz Radiation pattern

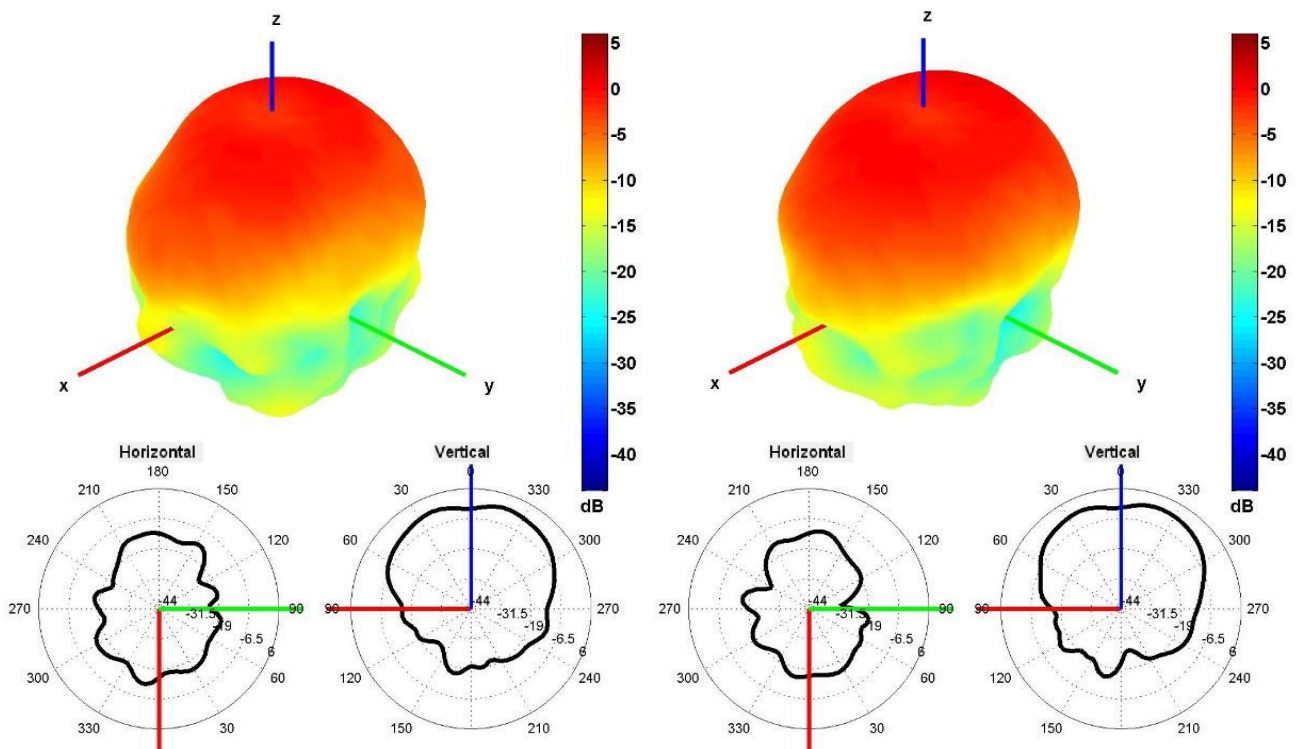

1950 and 2100 MHz Radiation pattern

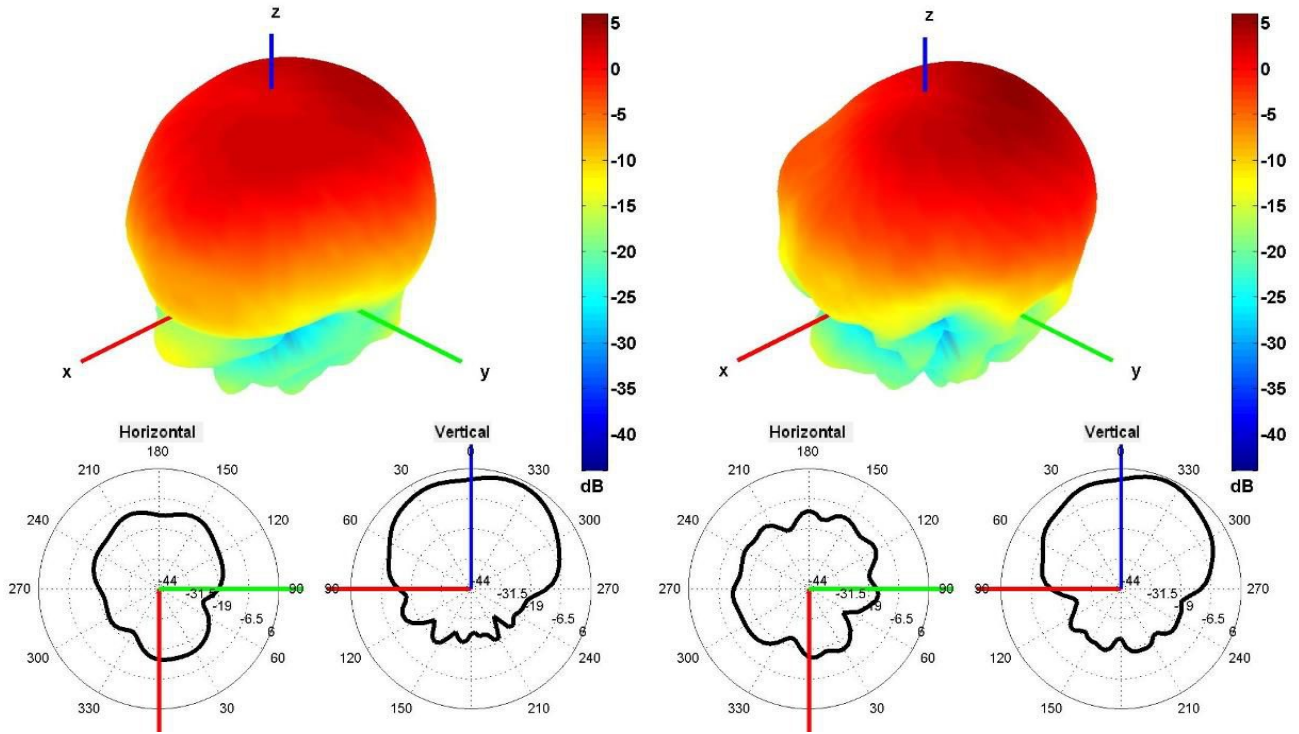

2350 and 2600 MHz Radiation pattern

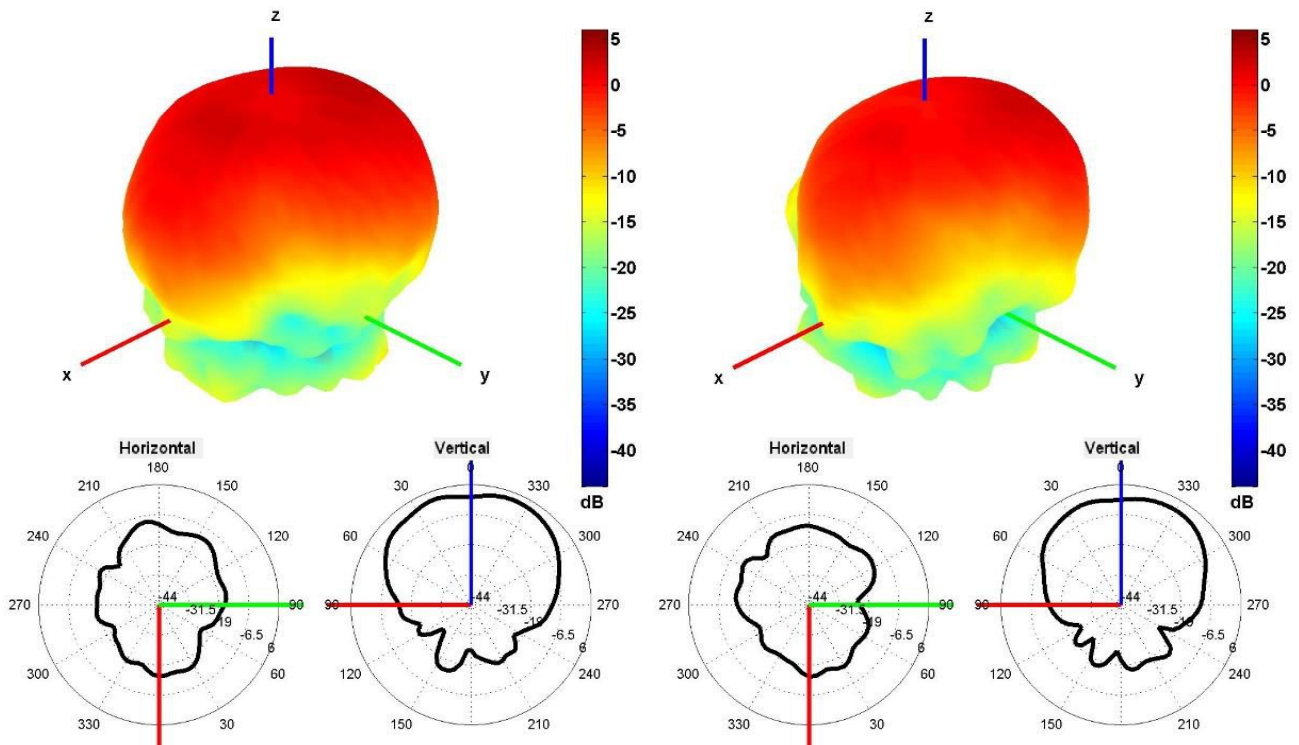

3350 and 3600 MHz Radiation pattern

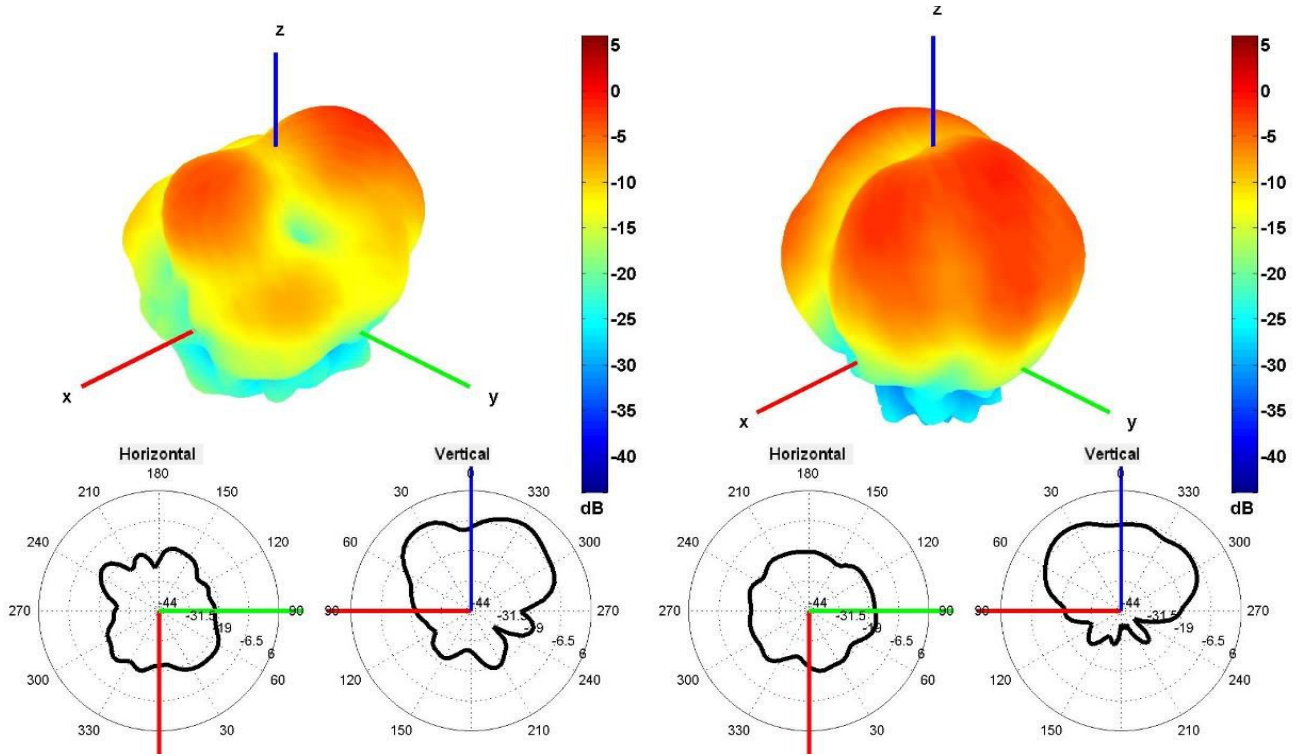

4500 and 5500 MHz Radiation pattern

Cable 3: WIFI-6-6E

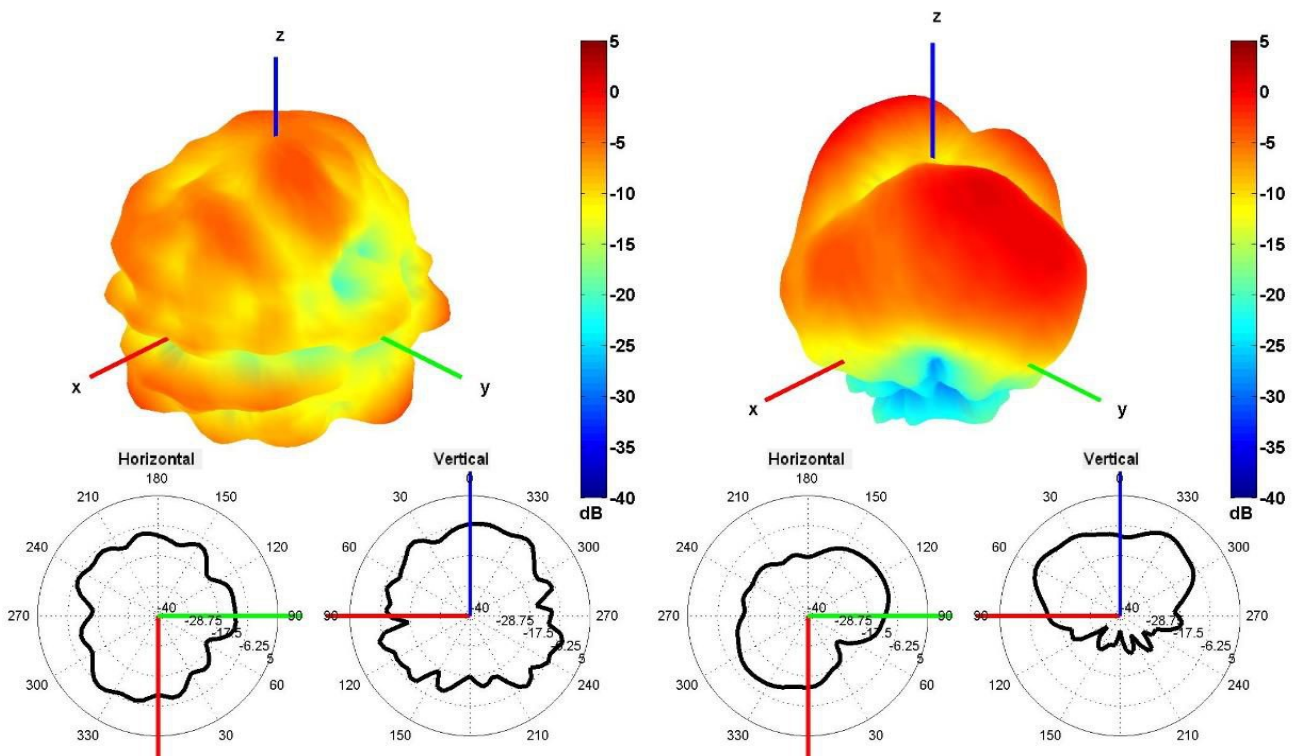

2450 and 5500 MHz Radiation pattern

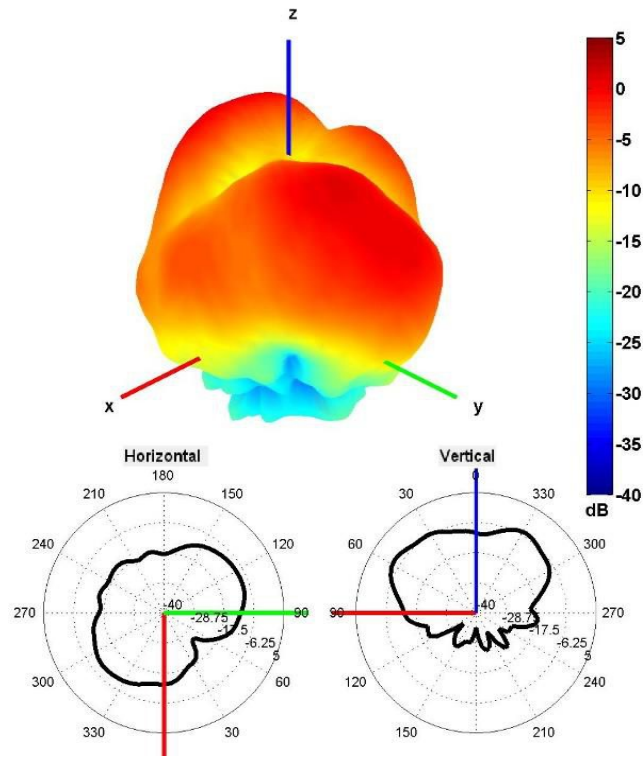

6500 MHz Radiation pattern

4. Antenna drawings

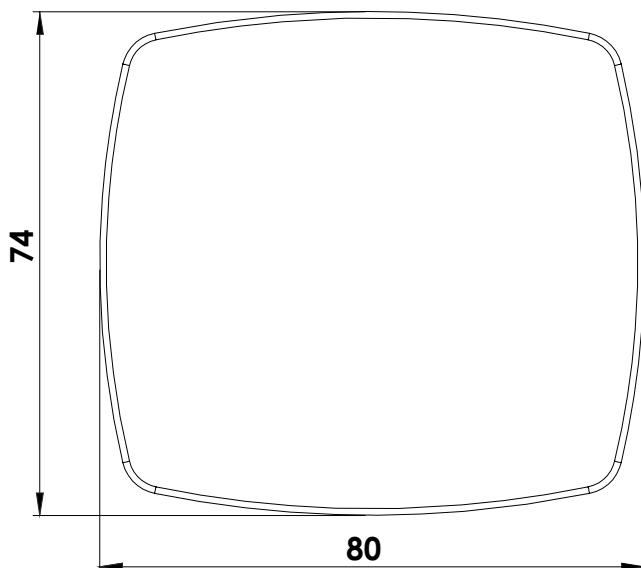
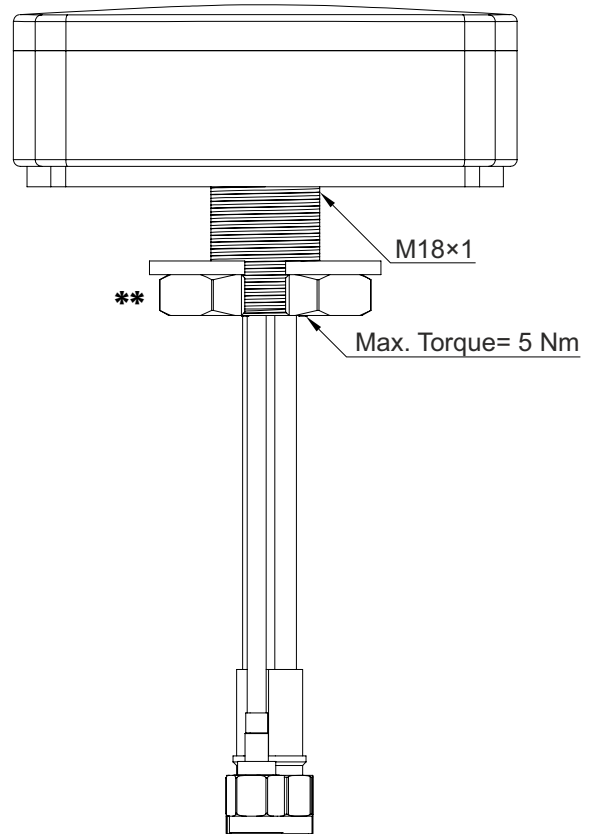
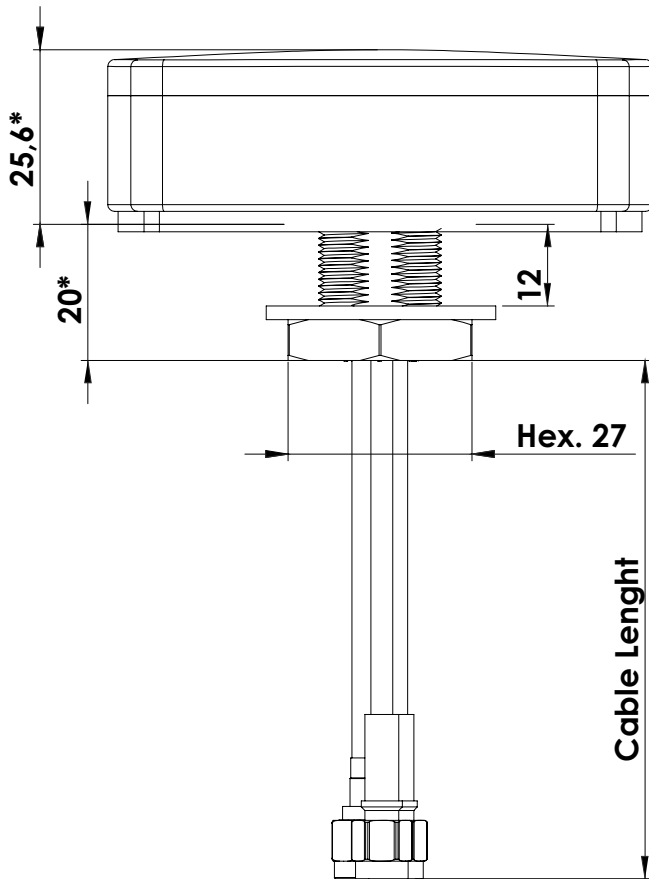

Mounting hole

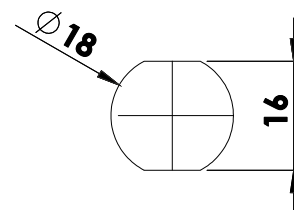

Max. mounting thickness 12mm
 Note: Dimensions are in millimeters
 *Dimensions are after mounting
 **Max. Torque= 5 Nm

5. Antenna Images

