















## ANTENNAS | MIMO-3-15 SERIES

# 5-IN-1 TRANSPORTATION & AUTOMOTIVE ANTENNA

410 - 3800 MHz; 2X2 LTE (MIMO), 5.8 dBi; 2X2 Wi-Fi (MIMO), 7 dBi; GPS/GLONASS, 21 dBi



 410 – 470 MHz; 698 -960 MHz; 1710 -2700 MHz; 3400 -3800 MHz	 LTE: 5.8 dBi; Wi-Fi: 7dBi; GPS: 21 dBi	 2X2 MIMO	 Omni- Directional	 410 – 470 MHz	 4G LTE	 5G Ready
 2.4-2.5 GHz 5.0-6.0 GHz	 IP 68	 Chemical Protection	 Machine to Machine	 GPS Included -40°C to +80°C	 -40°C to +80°C	 Fire Resistant
 CBRS Band						



- **5-in-1 High performance multi frequency 2G/3G/4G/LTE antenna (5G Ready)**
- **2X2 MIMO LTE, 2X2 MIMO Wi-Fi & GPS / GLONASS**
- **Ultra-wideband, includes 450 MHz and 3.5 GHz CBRS bands**
- **Robust and water-resistant antenna (IP 68)**
- **Ideal for transportation and marine use**
- **Multi mounting options for easy installation**

## Product Overview

The MIMO-3-15 is a 5-in-1 high performance multi frequency antenna within a single housing, providing two cellular, two Wi-Fi and a GPS/GLONASS antenna. The two cellular MIMO antennas (for 2G/3G/4G) covers the contemporary 698 MHz to 2700 MHz bands, as well as the new emerging LTE and 5G spectrum for 450MHz and 3.5GHz CBRS bands, which is becoming popular across the various international cellular network operators for LTE. The ultra-wideband performance of the antenna allows it to be used across different operators and technologies and is ready for future cellular technologies up to 3.8 GHz for 5G applications. The antenna provides two separate dual-band Wi-Fi antennas, providing concurrent 2.4 GHz and 5 GHz on each antenna with 2x2 MIMO capability. The fifth antenna is a high-performance active GPS/GLONASS system operating down to -40°C. The MIMO-3-15 exceeds the performance of most competitors due to the attention to the design of this high-performance antenna. The radiation patterns of all radiating elements provide an excellent balance between omnidirectionality, pattern diversity and good radiation abilities at the desired elevation. This is an important criterion for the transportation and marine market. which the antenna was specifically designed for. Main applications are for commercial/industrial vehicles, marine, M2M and other IoT systems using a wide range of radio technologies, while remaining futureproof over the wide frequency band.

## Features

- Ultra-wideband from 410 to 470 MHz, 698 to 2700 MHz and 3400 to 3800 MHz bands.
- Cleverly designed decorrelated antennas give superior MIMO performance in both Wi-Fi bands and cellular bands
- Above features maintained from 698 to 5800 MHz in relevant bands, including the 450 MHz
- Includes high-performance GPS/GLONASS antenna
- Careful mechanical design provides ruggedness, corrosion, water, dust resistance (IP 68)
- Ground plane independent: MIMO-3 is designed with an internal ground plane, making the antenna suitable for implementation on all surface types

## Application Areas

- Transport broadband and Wi-Fi distribution, automation and telemetry for Busses, Utility, Trucking & Public Safety vehicles
- Industrial factory automation, robotic machinery and other M2M systems telemetry
- Farming & Agricultural automation such as M2M & IoT
- Broadband cellular to Wi-Fi distribution for Marine / Boats (inland and near coastal vessels)
- Mining Vehicles & Machinery communications, telemetry and automation (M2M & IoT)

## MIMO-3-15



### Frequency Bands – Cellular & Wi-Fi

The MIMO-3-15 is suitable for the following Cellular frequency bands | 410-470 MHz | 698-960 MHz | 1710-2700 MHz | 3400-3800 MHz | and the following Wi-Fi frequency bands | 2400-2500 MHz | 5000-6000 MHz |

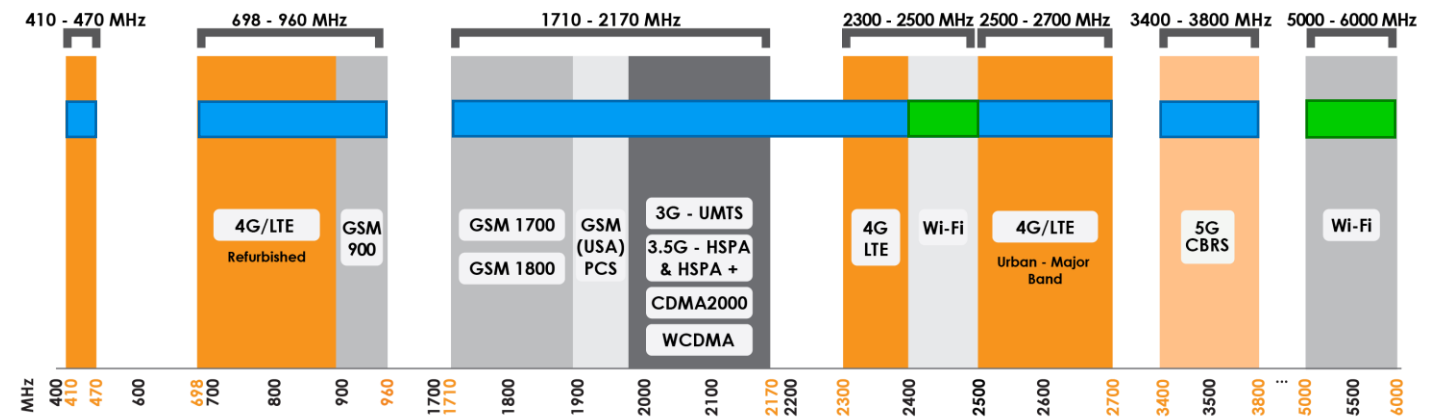

■ Indicates the LTE frequency bands which MIMO-3-15 supports      ■ Indicates the Wi-Fi frequency bands which MIMO-3-15 supports

### Antenna Derivatives

Product Order Code (SKU)	A-MIMO-0003-V2-15	A-MIMO-0003-V2-15-B
Radome colour	White	Black
Ports	1 & 2 – LTE, 3 & 4 - Wi-Fi 5 - GPS	1 & 2 – LTE, 3 & 4 - Wi-Fi 5 - GPS
SISO / MIMO	2x2 MIMO – LTE 2x2 MIMO – Wi-Fi	2x2 MIMO – LTE 2x2 MIMO – Wi-Fi
Coax Cable Type	Twin HDF 195 – LTE & Wi-Fi RTK-031 - GPS	Twin HDF 195 – LTE & Wi-Fi RTK-031 - GPS
Coax Cable Length	2m – LTE, Wi-Fi & GPS	2m – LTE, Wi-Fi & GPS
Connector Type	SMA (M) - LTE, Wi-Fi & GPS	SMA (M) - LTE, Wi-Fi & GPS
EAN	0707273470263	6009710922101

*\*The coax cable & connector are factory mounted to the antenna*

## Electrical Specifications - Cellular

Frequency bands:	410-470 MHz 698-960 MHz 1710-2700 MHz 3400-3800 MHz
Gain (max) Port 1 & 2:	1 dBi @ 410-470 MHz 3.5 dBi @ 698-960 MHz 5.8 dBi @ 1710-2700 MHz 4 dBi @ 3400-3800 MHz
VSWR Port 1 & 2:	≤ 2.5:1 across 90% of the bands
Feed power handling:	10 W
Input impedance:	50 Ohm (nominal)
Polarisation:	Linear Vertical
Coax cable loss:	0.232 dB/m @ 400 MHz 0.362 dB/m @ 900 MHz 0.514 dB/m @ 1800 MHz 0.603 dB/m @ 3000 MHz
Path to Ground:	Yes

## GPS/Glonass Antenna Electrical Specifications

Frequency Range (GPS):	1575.42MHz/1600MHz
Gain (Max):	21+/-2dBi
VSWR:	≤1.5:1
DC Voltage:	2.7-3.3 V
DC Current:	5-15mA
Noise Figure:	≤1.5 dB
Nominal Impedance:	50 Ω
Polarisation:	RHCP
Filter Out Band Attenuation:	12dB Min f0+50MHz, 16dBi Min f0-50MHz
Voltage:	2.7 - 3.3V
Max. Power-W:	50
Coax cable loss:	0.65 dB/m @ 1500 MHz

## Wi-Fi Electrical Specifications

Frequency:	2400-2500 MHz 5000-6000 MHz
Gain (Max):	5 dBi @ 2400-2500 MHz 7 dBi @ 5000-6000 MHz
VSWR:	≤ 2.5:1 over 95% of the band
Feed power handling:	10 W
Nominal input impedance:	50 Ohm (nominal)
Coax cable loss:	0.533 dB/m @ 2400 MHz 1.07 dB/m @ 5800 MHz
Path to Ground:	Yes

## Product Box Contents

Antenna:	A-MIMO-0003-V2-15 or A-MIMO-003-V2-15-B
Mounting bracket:	Threaded Spigots (Up to 60mm clamping thickness), Adhesive Surface Mounting & Optional Magnetic Mount
Adapters:	RPSMA(m) To SMA (f)

## Mechanical Specifications

Product dimensions	253 mm x 128 mm x 144 mm
Packaged dimensions:	265 mm x 211 mm x 204 mm
Weight:	1.36 kg
Packaged weight:	1.46 kg
Radome material:	UV Stable ASA
Mounting Type:	Spigot, Surface with Magnetic mount option

## Environmental Specifications, Certification & Approvals

Wind Survival:	≤220 km/h
Temperature Range (Operating):	-40°C to +80°C
Environmental Conditions:	Outdoor/Indoor
Water ingress protection ratio/standard:	IP 68
Salt Spray:	MIL-STD 810F/ASTM B117
Operating Relative Humidity:	Up to 98%
Storage Humidity:	5% to 95% - non-condensing
Storage Temperature:	-40°C to +80°C
Enclosure Flammability Rating:	UL 94-HB
Impact resistance:	IK 10
Product Safety & Environmental:	Complies with CE and RoHS standards



Technical Drawings

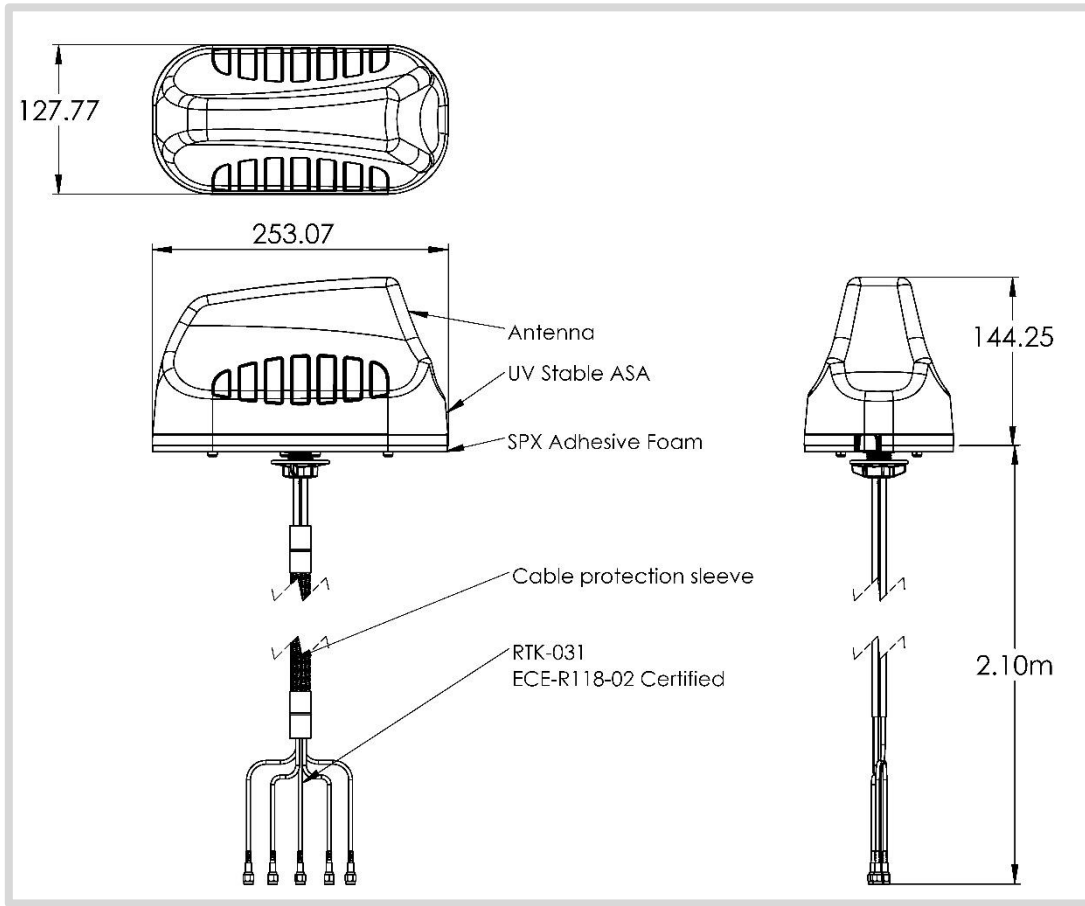

Antenna Performance Plots

VSWR: Cellular Antenna

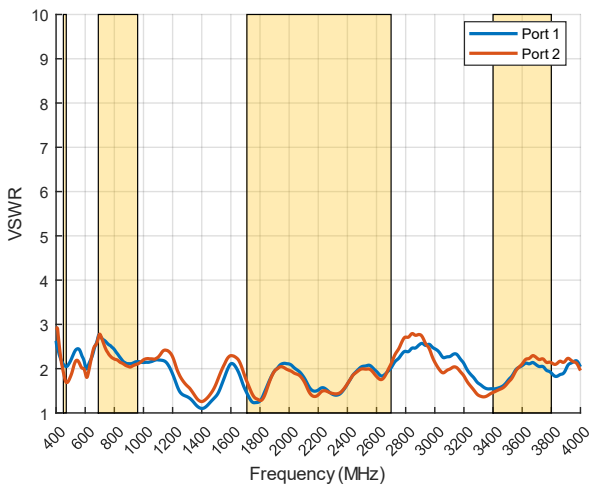

Gain: Cellular Antenna (EXCLUDING CABLE LOSS)

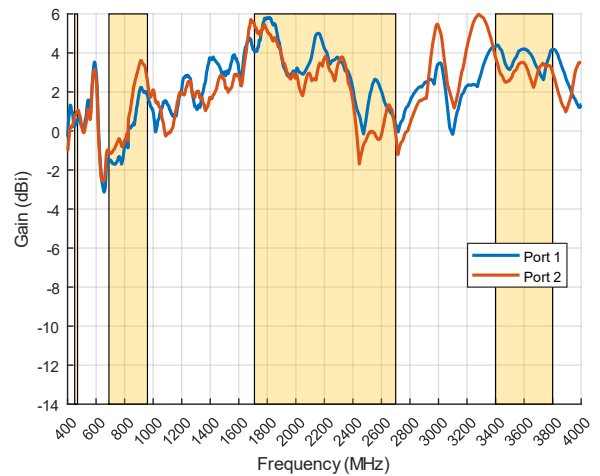

Voltage Standing Wave Ratio (VSWR)\*

VSWR is a measure of how efficiently radio-frequency power is transmitted from a power source, through a transmission line, into a load. In an ideal system, 100% of the energy is transmitted which corresponds to a VSWR of 1:1.

The MIMO-3-15 delivers superior performance across all bands with a VSWR of  $\leq 2.5:1$  across 90% of the band

\*Measured with 2m low loss cable, 650 x 650 mm ground plane, and unused ports terminated with 50Ω load.

Gain\* in dBi

5.8 dBi is the peak gain across all bands from 410 -3800 MHz

Gain @ 410-470 MHz:	1 dBi
Gain @ 698-960 MHz:	3.5 dBi
Gain @ 1710-2700 MHz:	5.8 dBi
Gain @ 3400-3800 MHz:	4 dBi

\*Antenna gain measured with polarisation aligned standard antenna

**VSWR: Wi-Fi Antenna**

**Gain: Wi-Fi Antenna (EXCLUDING CABLE LOSS)**

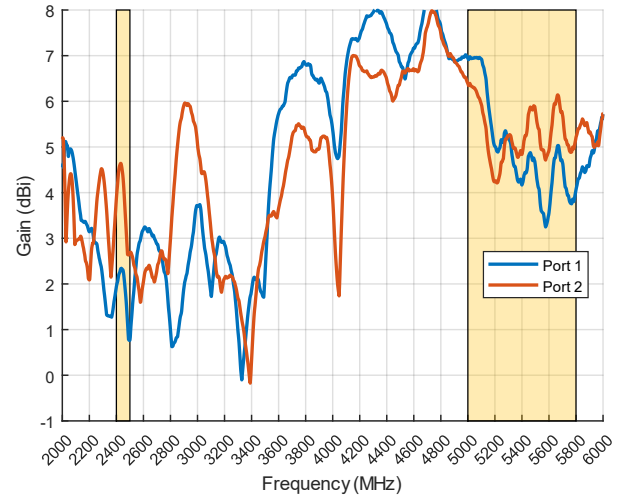
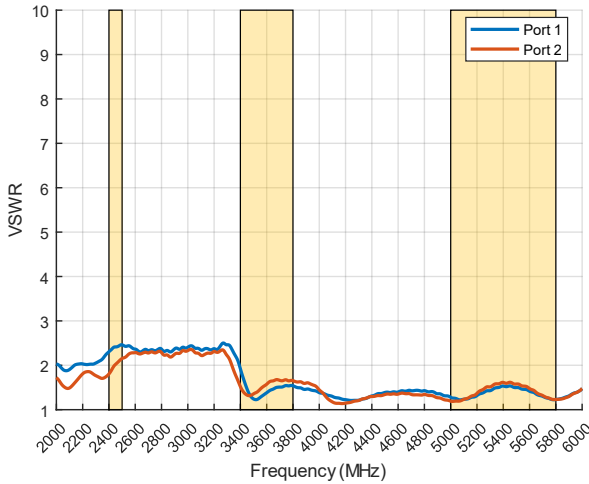

**Voltage Standing Wave Ratio (VSWR)\***

VSWR is a measure of how efficiently radio-frequency power is transmitted from a power source, through a transmission line, into a load. In an ideal system, 100% of the energy is transmitted which corresponds to a VSWR of 1:1.

The MIMO-3-15 delivers superior performance across all bands with a VSWR of  $\leq 2.5:1$  over 95% of the band

*\*Measured with 2m low loss cable, 650 x 650 mm ground plane, and unused ports terminated with 50Ω load.*

**Gain in dBi**

7 dBi is the peak gain across all bands from 2400-2500 & 5000 – 6000 MHz

Gain @ 2400-2500 MHz:	5 dBi
Gain @ 5000-6000 MHz:	7 dBi

**Radiation Patterns – Cellular**

Azimuth (Top View): 410–470 MHz

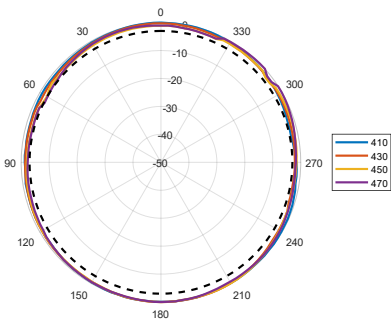

Azimuth (Top View): 698–960 MHz

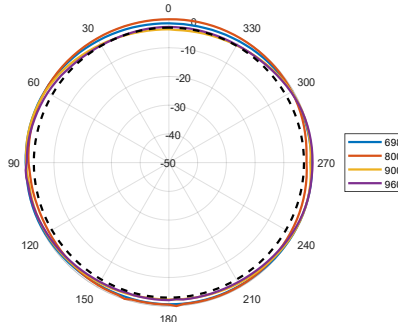

Azimuth (Top View): 1710–2100 MHz

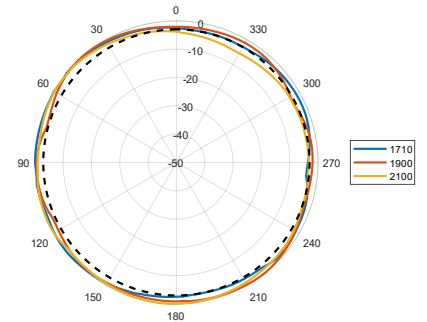

Azimuth (Top View): 2300–2700 MHz

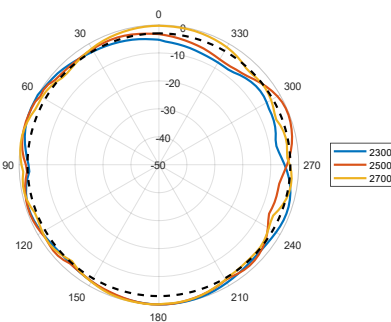

Azimuth (Top View): 3400–3800 MHz

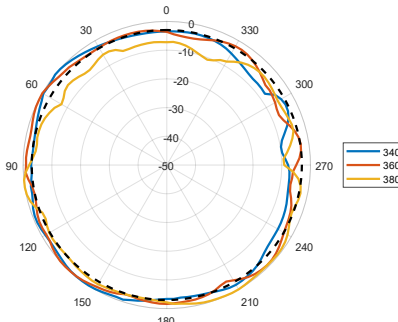

Elevation (Side View): 410–470 MHz

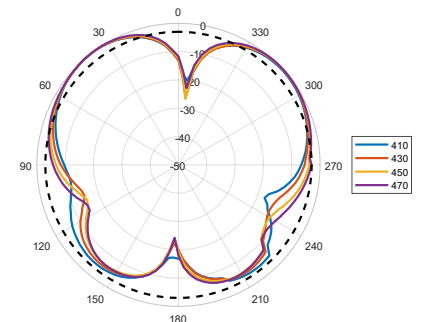

Elevation1 (Side View): 698-960 MHz

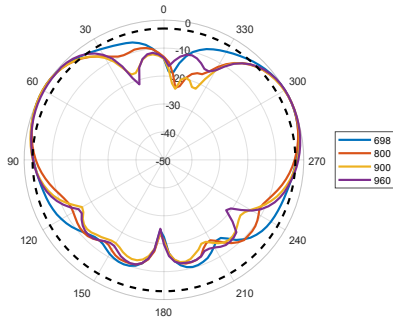

Elevation1 (Side View): 1710-2100 MHz

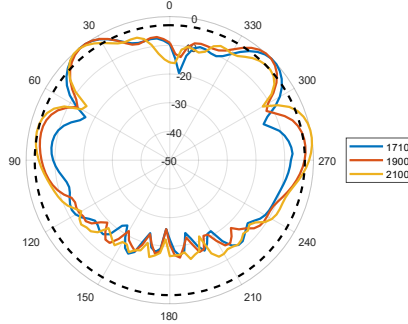

Elevation1 (Side View): 2300-2700 MHz

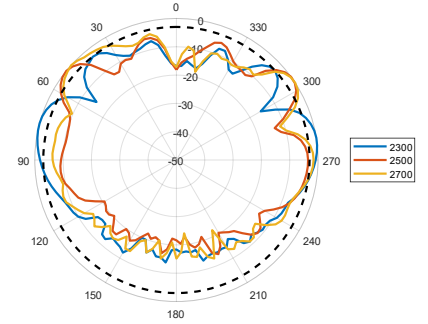

Elevation1 (Side View): 3400-3800 MHz

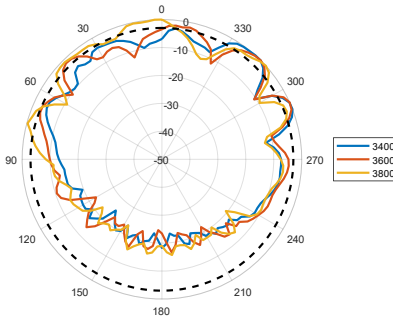

Elevation2 (Side View): 410-470 MHz

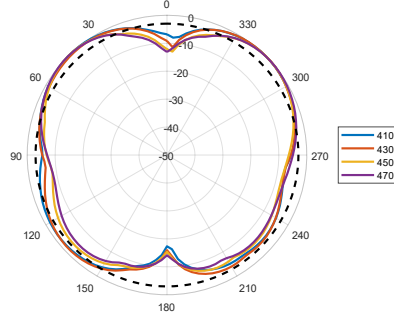

Elevation2 (Side View): 698-960 MHz

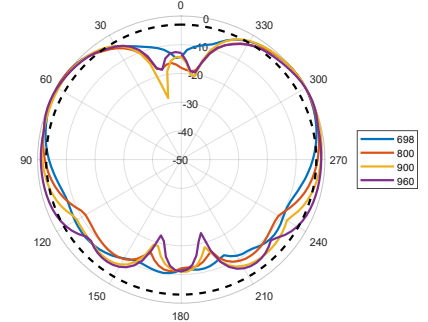

Elevation2 (Side View): 1710-2100 MHz

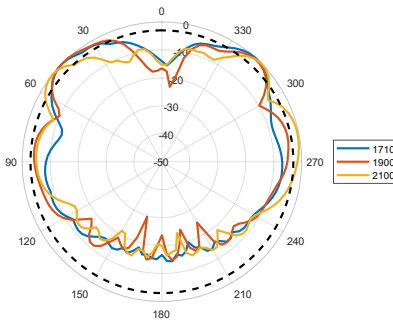

Elevation2 (Side View): 2300-2700 MHz

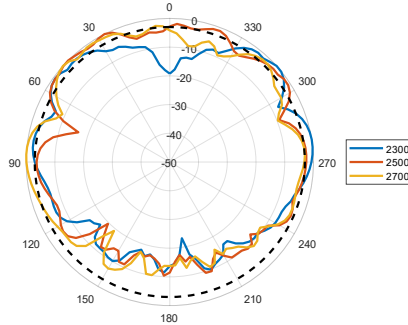

Elevation2 (Side View): 3400-3800 MHz

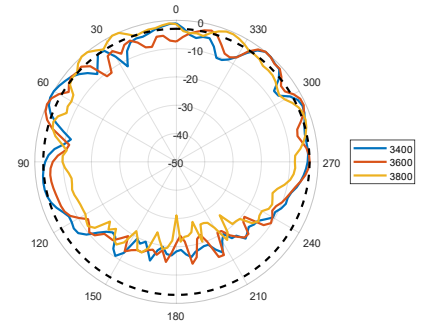

### Radiation Patterns – Wi-Fi

Azimuth (Top View): 2400-2500 MHz

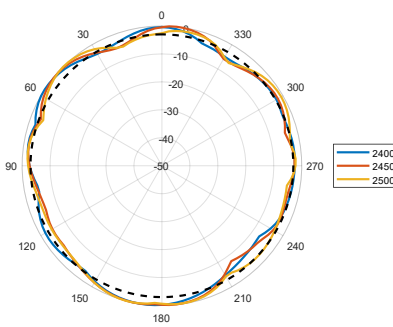

Azimuth (Top View): 5000-5400 MHz

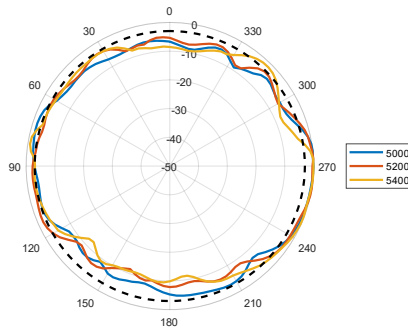

Azimuth (Top View): 5600-5800 MHz

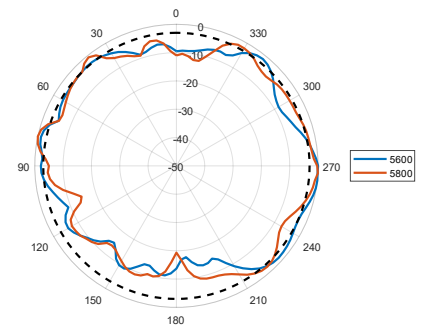

Elevation1 (Side View): 2400-2500 MHz

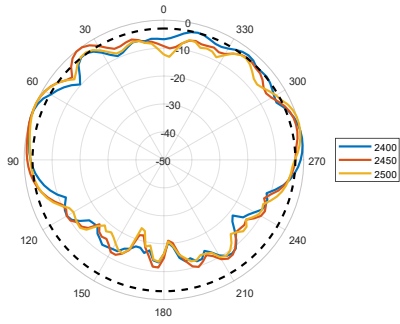

Elevation1 (Side View): 5000-5400 MHz

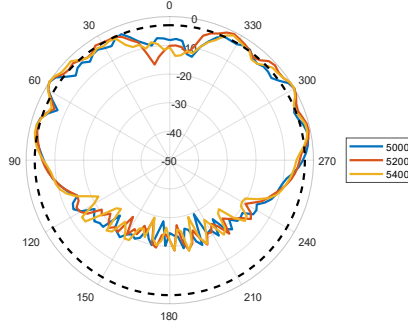

Elevation (Side View): 5600-5800 MHz

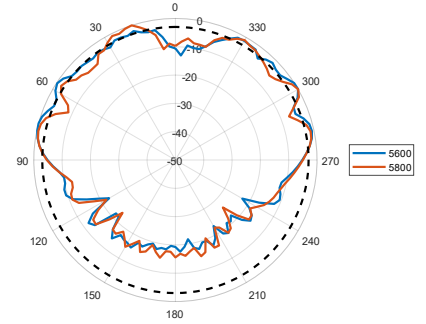

Elevation2 (Side View): 2400-2500 MHz

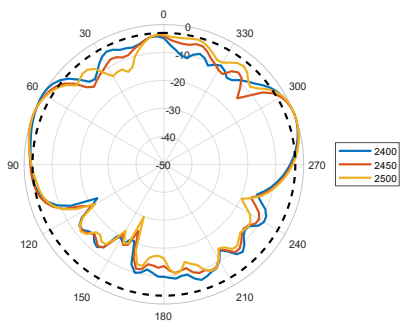

Elevation2 (Side View): 5000-5400 MHz

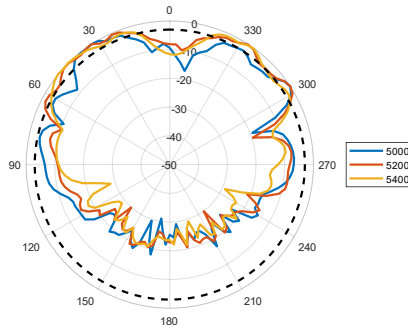

Elevation2 (Side View): 5600-5800 MHz

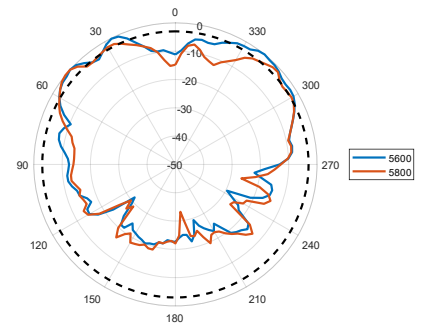

### Radiation Patterns – GPS

XY Plane: 1561-1602 MHz

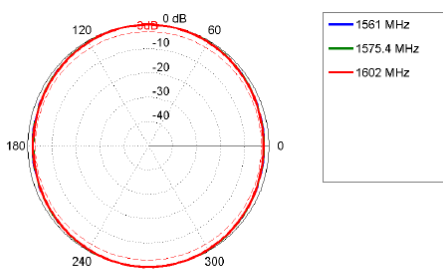

XZ Plane: 1561-1602 MHz

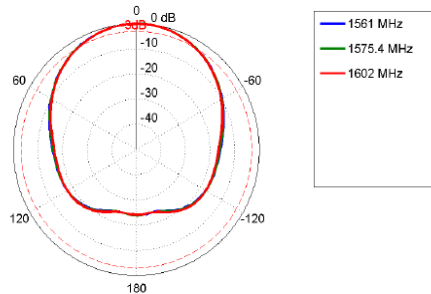

YZ Plane: 1561-1602 MHz

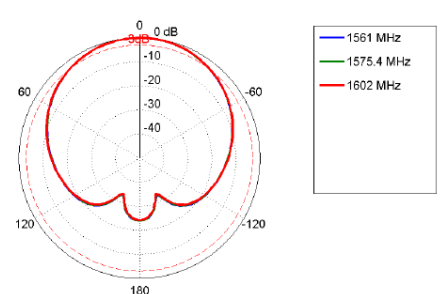

## Mounting Options

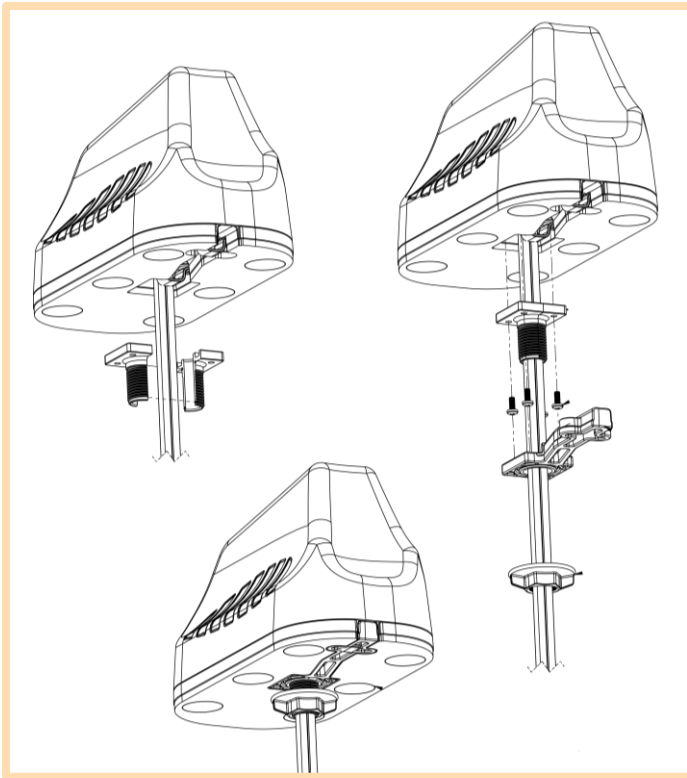

### Standard Spigot Mount

Threaded Spigot Mounting

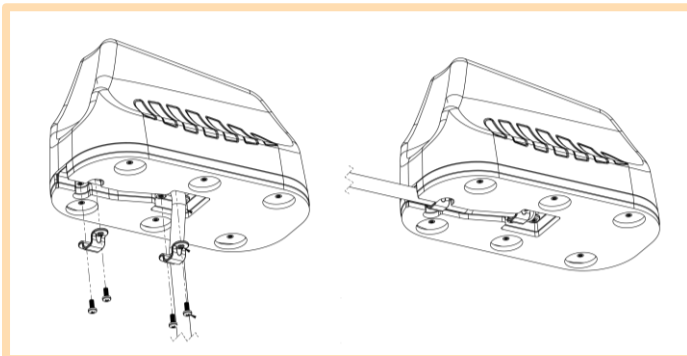

### Surface Mount

Adhesive Surface Mounting

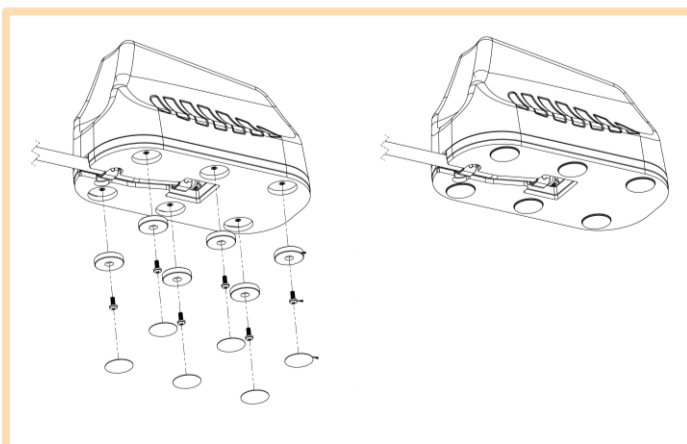

### Magnetic Mount

Optional Magnetic Base Kit



## Additional Accessories



### A-MBK-0001-V1.0

Magnetic Base Kit



### A-CAB-118

5 x 5m Extension cables for 5-in-1 Antennas



### A-CAB-119

5 x 3m Extension cables for 5-in-1 Antennas

## Contact Poynting

### Poynting Antennas (Pty) Ltd - Head Office

Unit 4, N1 Industrial Park  
Landmarks Avenue,  
Samrand, 0157  
South Africa

**Phone:** +27 (0) 12 657 0050

**E-mail:** sales@poynting.co.za

### Poynting Europe

Regus Business Center Neue Messe Riem  
Kronstadter Straße 4  
81677 München  
Germany

**Phone:** +49 89 208026538

**E-mail:** sales-europe@poynting.tech