



Ruijie RG-WS6008 Series Wireless Controllers

Hardware Installation and Reference Guide V1.0



Copyright statement

Ruijie Networks©2019

Ruijie Networks reserves all copyrights of this document. Any reproduction, excerption, backup, modification, transmission, translation or commercial use of this document or any portion of this document, in any form or by any means, without the prior written consent of Ruijie Networks is prohibited.

Exemption statement

This document is provided “as is”. The contents of this document are subject to change without any notice. Please obtain the latest information through the Ruijie Networks website. Ruijie Networks endeavors to ensure content accuracy and will not shoulder any responsibility for losses and damages caused due to content omissions, inaccuracies or errors.



Preface

Thank you for using our products. This manual will guide you through the installation of the wireless controller.

Scope

It is intended for the users who have some experience in installing and maintaining network hardware. At the same time, it is assumed that the users are already familiar with the related terms and concepts.

Obtaining Technical Assistance

- Ruijie Networks Website: <https://www.ruijienetworks.com/>
- Technical Support Website: <https://ruijienetworks.com/support>
- Case Portal: <https://caseportal.ruijienetworks.com>
- Community: <https://community.ruijienetworks.com>
- Technical Support Email: service_rj@ruijienetworks.com
- Skype: [service_rj@ruijienetworks.com](https://www.skype.com/people/service_rj@ruijienetworks.com)

Related Documents

Documents	Description
Configuration Guide	Describes network protocols and related mechanisms that supported by the product, with configuration examples.
Command Reference	Describes the related configuration commands, including command modes, parameter descriptions, usage guides, and related examples.

Documentation Conventions

The symbols used in this document are described as below:



Note This symbol brings your attention to some helpful suggestions and references.

**Caution**

This symbol means that you must be extremely careful not to do some things that may damage the device or cause data loss.

1 Product Overview

The RG-WS6008 wireless LAN controller is introduced by Ruijie Networks to provide powerful access control capability for medium-large-sized wireless networks.

1.1 RG-WS6008

Table 1-1 Technical Specifications of RG-WS6008

Model	RG-WS6008
Memory	DDR3 SDRAM: 2GB
	BOOTROM: 8MB
	FLASH: 128MB
Port	Eight RJ45 copper ports, two Gigabit SFP fiber ports Port 7 and 8 are combo ports (copper/fiber)
	One console port
	Two USB ports
Interface Standard	Ethernet port: 10Base-T/100Base-TX/1000Base-TX and 1000BASE-SX/LX/ZX
	Configuration port (Console port): RS-232
Dimensions (W x D x H)	440 mm x 200 mm x 43.6 mm (excluding foot pad)
Voltage	100-240V~, 50/60Hz
Power Consumption	40W max.
Operating Temperature	0°C to 45°C (32°F to 113°F)
Operating Humidity	5% to 95% RH (noncondensing)

i The system may not support all USB disks. It is recommended to use the Kingston USB disk and set the file system format to FAT32.

! Avoid vibration and concussion when moving the wireless controller.

! RG-WS6008 wireless controller is a class A product. In a domestic environment, this product may cause radio interference, in which case the user may be required to take adequate measures.

Product Image

Figure 1-1 Front Panel of RG-WS6008

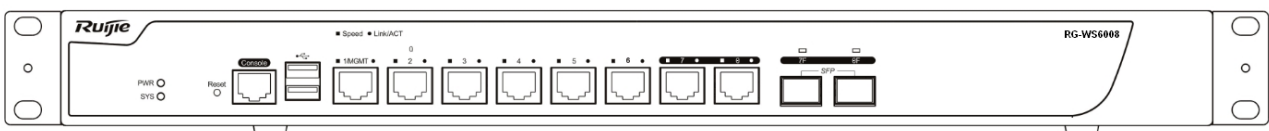
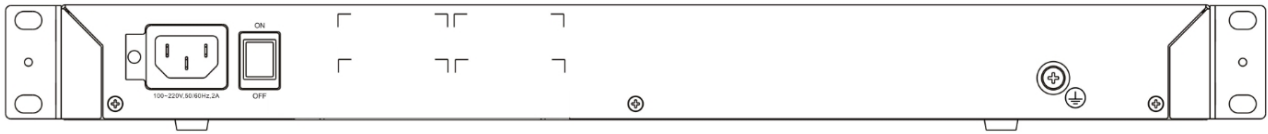

Figure 1-2 Rear Panel of RG-WS6008



LED Indicators

LED	State	Meaning
PWR	Off	The power module is NOT in the position or fails.
	Solid green	The power module is operational.
SYS	Blinking green	The system is being initialized.
	Solid green	The initialization process is complete.
	Solid red	The system sends out an alarm.
1-8 Gigabit copper ports (link/ACT)	Solid green	The copper port is connected at 10/100/1000 Mbps.
	Blinking green	The copper port is receiving or transmitting data.
1-8 Gigabit copper ports (speed)	Solid orange	The copper port is connected at 1000 Mbps.
	Off	The copper port is connected at 10/100 Mbps.
7F-8F Gigabit fiber ports	Solid green	The fiber port is connected.
	Blinking green	The fiber port is receiving or transmitting data.

2 Preparation for Installation

2.1 Precautions

The wireless controller acts as a network repeater and its working affects the normal operation of the whole network.

The following suggestions are advised for the installation and use of RG-WS6008:

- Do not place the wireless controller in a damp/wet location. Do not let any liquid enter the chassis.
 - Keep the wireless controller far away from the heat source.
 - Ensure that the wireless controller is properly grounded.
 - Wear an anti-static wrist strap during installation and maintenance.
 - Do not wear loose clothes to avoid hooking any parts. Before operation, tighten your band, shawl, and sleeves.
 - Put the tools and parts away from where people walk by.
 - Use UPS to prevent power failure and other interferences.
 - If the clock is not accurate, check whether the clock has been configured. If not, the inaccuracy is likely to occur. If the clock has been configured, the inaccuracy may be caused by the battery running out of power. In general, the button battery lasts about 10 years.
-
- i** Misuse of battery may cause damage to the device or hurt to people. Do not replace battery by yourself. Instead, contact Ruijie Service Center for the replacement of battery.
 - i** This device is an A-class product. It may cause radio interference in living environment, which may require you to take anti-interference measures.
 - i** Keep the device within the restricted-access area.
 - i** The device should be installed by professionals or technicians.
-

2.2 Preparing Installation Site

RG-WS6008 is for indoor use only. To ensure its normal operation and prolong its life span, the installation site should meet the following requirement:

2.2.1 Temperature and Humidity Requirements

To ensure normal operation and service life of the device, maintain appropriate temperature and humidity levels in your equipment room. See Table 2-1. Improper room temperature and humidity can cause damages to the device. High relative humidity may affect insulation materials, resulting in poor insulation and even electrical leakage, and sometimes may lead to change of mechanical properties of materials and corrosion of metal parts. Low relative humidity may dry and shrink insulation sheets and cause static electricity that can damage the circuitry inside the device. High temperature greatly reduces reliability of the device and shortens its service life.

Table 2-1 Required Temperature and Humidity for the RG-WS6008

Relative Temperature	Relative Humidity
----------------------	-------------------

Long-time Condition	Working	Short-time Condition	working	Long-time Condition	Working	Short-time Condition	Working
15°C to 30°C (59°F to 86°F)		0°C to 45°C (32°F to 113°F)		40%~65%		5%~95%	

- i** The ambient temperature and humidity are measured at a point 1.5 meters (4.9 feet) above the ground and 0.4 meters (1.3 feet) before the device when there is no protective board in the front or back of the rack.
- i** The short-term working condition refers to a period no longer than consecutive 48 hours or accumulated 15 days a year.
- i** The extreme working condition refers to the temperature and humidity of the machine room where the air conditioner fails for no more than five hours.

2.2.2 Cleanness Requirements

Dust poses a serious threat to device operation. Dust that falls onto the surface of the device can be absorbed onto metal contact points by static electricity, resulting in poor contact. Electrostatic absorption of dust occurs more easily when the relative humidity is low, which may shorten the service life of the device and cause communication failures. Table 2-2 shows the maximum concentration and diameter of dust allowed in the equipment room.

Table 2-2

Maximum Diameter (μm)	0.5	1	3	5
Maximum Content (Number of Particles in one Cubic Meter)	1.4×10 ⁷	7×10 ⁵	2.4×10 ⁵	1.3×10 ⁵

Besides, the contents of salts, acids and sulfides in the air are also strictly limited for the equipment room. These substances can accelerate metal corrosion and the aging of some parts. Table 2-3 describes the limit of some hazardous gases such as SO₂, H₂S, NO₂ and Cl₂ in the equipment room.

Table 2-3

Gas	Average (mg/m ³)	Maximum (mg/m ³)
SO ₂	0.2	1.5
H ₂ S	0.006	0.03
NO ₂	0.04	0.15
NH ₃	0.05	0.15
Cl ₂	0.01	0.3

2.2.3 Static Discharge Damage Prevention

Although much has been done in RG-WS6008 to prevent static electricity, great damage may be caused to the circuitry when the static electricity exceeds a certain limit. Electrostatic induction may come from the following sources:

- External electric field produced by the high-voltage supply cable, lightning, etc;
- Internal systems such as the indoor floor and the entire structure.

To prevent damage from static electricity, you must pay attention to the following:

- Properly ground the equipment.
- Take dust prevention measures in the room.

- Maintain an appropriate humidity and temperature.
- Always wear an anti-static wrist strap when you touch any circuit board.
- Place the circuit board on an anti-static workbench or in an anti-static shielding bag.
- Try to hold a circuit board by its edges. Do not touch any components or the PCB.

2.2.4 Anti-Interference Requirements

The wireless controller is susceptible to external interference such as electromagnetic wave and current. Note that:

- Provide the power system with effective anti-interference measures.
- It is recommended that the wireless controller be installed far away from the grounding device.
- Keep the wireless controller away from high-power radio stations, radar stations, and high-frequency high-current devices.
- Use EMI shielding when necessary.

2.2.5 Installation Site Requirements

To install the wireless controller whether in the cabinet or on the workbench, pay attention to the following items:

- Ensure that enough space is reserved around the air inlet and exhaust vents for ventilation and heat dissipation. It is recommended that the wireless controller be installed in a standard 19-inch cabinet. Otherwise, use a clean platform as a workbench. It is recommended to equip the installation site with an air conditioner if it is hot.
- Ensure that the cabinet or the workbench is provided with proper ventilation and heat dissipation system.
- Ensure that the cabinet or the workbench is sound enough to bear the weight of the wireless controller and its accessories.
- Ensure that the cabinet or the workbench is properly grounded.

2.3 Installation Tools

Installation Tool	Cross screwdriver and anti-static wrist strap
Cable	Power cord, configuration cable, Ethernet cable and grounding cable
Device	Hub/switch, configuration terminal (such as PC with Hyperterm) and power socket

3 Installing Wireless Controller

3.1 Installation Flowchart

Please follow the following procedure to install the wireless controller to ensure the smooth installation and avoid any damage to the device.

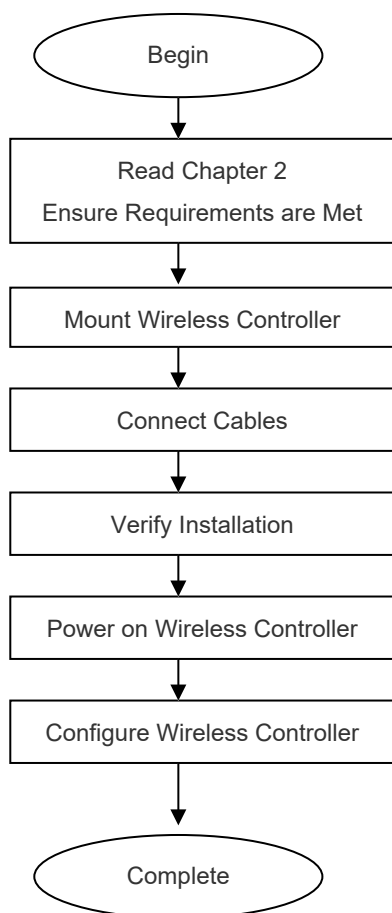

3.2 Mounting Wireless Controller

Now the wireless controller is ready for installation. Mount it to either of these two places.

- A cabinet
- A workbench

3.2.1 Mounting RG-WS6008 in Cabinet

RG-WS6008 is designed according to the specification of 19-inch standard cabinet. Use the supplied mounting accessory for installation.

3.2.2 Mounting RG-WS6008 on Workbench

In the absence of a 19-inch standard cabinet, install the wireless controller on a clean workbench. During the operation, pay attention to the following items:

- The workbench is firm and well-grounded.
- The supplied plastic cushion is stuck to the small hole at the bottom of the wireless controller and a 10 cm clearance is reserved for dissipation.
- No weight is placed on the top of the wireless controller.

3.3 Installing Power Cable

RG-WS6008 supports AC (100 VAC to 240 VAC; 50/60 Hz). Make sure that your power supply meets the requirement.

i See Chapter 1 for details about the power module.

RG-WS6008 uses three-wire power cable. It is recommended to use single-phase three-wire power socket or multi-functional microcomputer socket with neutral-point connector. The neutral-point needs to be grounded safely. Check whether the power supply in your building is grounded properly.

Follow the following steps to install the power cable:

1. Connect one end of the supplied power cable to the socket on the rear panel of the device and another to the AC power socket.
2. Check the power indicator on the front panel is on. If it is, it means that the power cable is correctly connected.

3.4 EMS & Secure Grounding

The ground required for EMC design includes shielding ground, filter ground, noise and interference suppression, and level reference. All the above constitute the comprehensive grounding requirements. The grounding resistance should be smaller than 1Ω. The RG-WS6008 wireless controller has a grounding pole on the rear panel, as shown in Figure 3-1.

Figure 3-1 RG-WS6008 Grounding

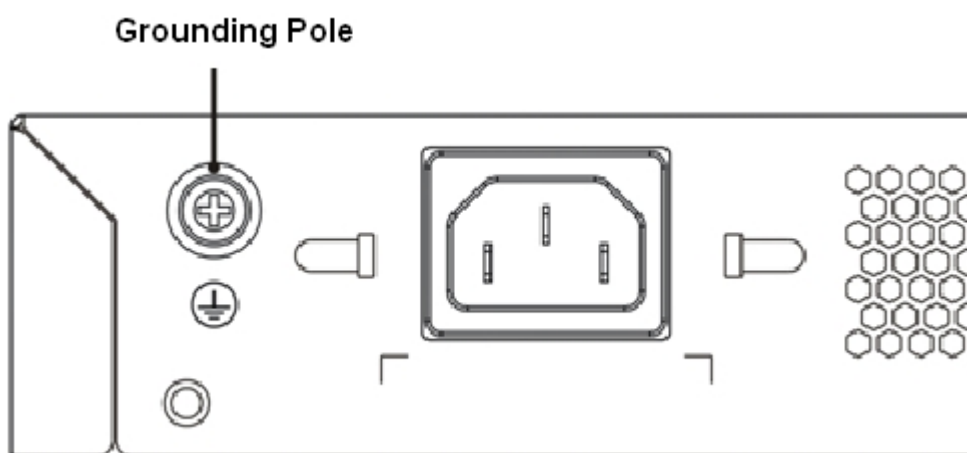

3.5 Connecting Console

RG-WS6008 supplies an EIA/TIA-232 configuration console for local configuration. If you configure RG-WS6008 through Web, skip this part.

Table 3-2 Console Attributes

Parameter	Description
Connector	RJ-45
Interface Standard	Asynchronous EIA/TIA-232
Baud Rate	57,600 bps, 115,200 bps, 9,600 bps (default)
Supported Services	<ol style="list-style-type: none">1. Command line interface2. Connection to character terminals3. Providing terminal access service as an asynchronous interface

Connect one end of the supplied configuration cable to the console port of the wireless controller, and the other end to the DB-9 male serial adapter of the microcomputer.

3.6 Verification

When you have installed the wireless controller, before powering on it, pay attention to the following items:

- If the wireless controller is stalled in a cabinet, check the mounting brackets of the cabinet and wireless controller are firm. If the wireless controller is installed on the workbench, check there is enough room around the wireless controller for heat dissipation and the workbench is firm.
 - Check the power supply meets the requirements.
 - Check the grounding cable is correctly connected.
 - Check the wireless controller is connected correctly to other devices such as the configuration terminal.
-

4 Configuration Guide

4.1 Setting up Configuration Environment

When you use the wireless controller for the very first time, you will need to configure it through a console port as follows:

- As shown in the following figure, connect the serial port of a character terminal or microcomputer to the console port through an RS232 cable.
- Set the communication parameters of the terminal. For a microcomputer, you will need to run a terminal emulation program like Windows operating system's Hyperterm. Take Hyperterm for example.

Run Hyperterm and create a connection.

Select the serial port to be connected with the console port of the wireless controller, as shown in figure 4-2.

Set communication parameters as follows: baud rate to 9600, data bit to 8, stop bit to 1, parity to No, flow control to No, as shown in figure 4-3.

Go to **File->Property->Settings** and set terminal emulation type to VT100.

Figure 4-1 Creating Connection



Figure 4-2 Selecting Serial Port to be Connected with Console Port.



Figure 4-3 Setting Communication Parameters for Serial Port.

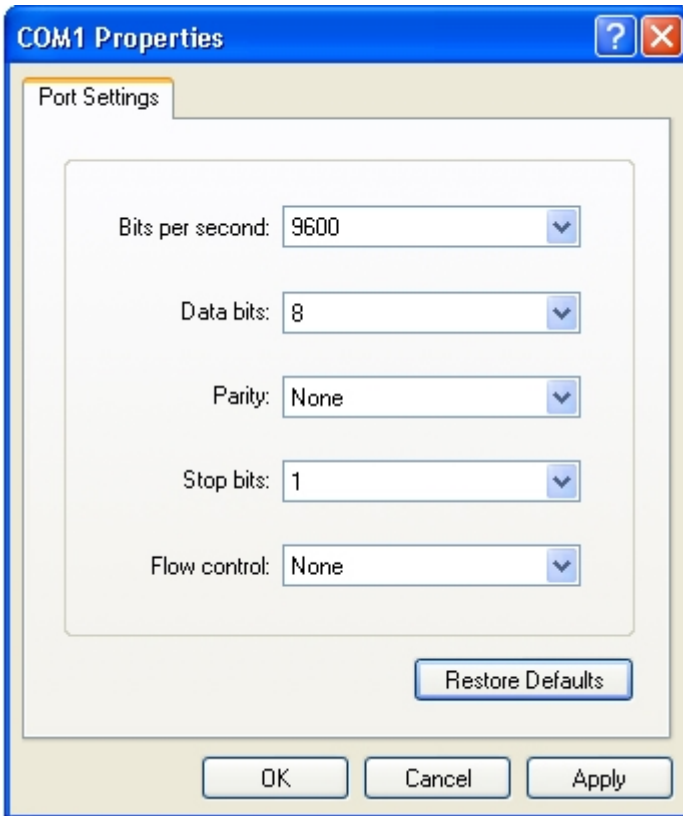

After building the configuration environment, you may power on the wireless controller

4.2 Powering on Wireless Controller

4.2.1 Verification Before Power-on

Before powering on the wireless controller, please check the following items:

- If the power cable and the grounding cable are connected correctly.
- If the power supply voltage meets the requirement.
- If the configuration cable is connected correctly, the microcomputer or terminal is turned on, and the setting is complete.

i Before powering on the wireless controller, check the position of the power switch so that you may cut power supply in time in case of accident.

4.2.2 Power-on

- Turn on the power supply.
- Turn the power switch of the wireless controller to the **on** position.

4.2.3 Verification After Power-on

After powering on the wireless controller, please check the following items:

- If the ventilation system is functional.

When the wireless controller is powered on, you will hear the fan working. Put your hand near the air inlet and exhaust vents, you will feel the air flowing.

- If the indicators on the front panel of the wireless controller are in the proper state.

See **LED Indicators** in Chapter 1.

- If the configuration terminal displays information as expected.

When the wireless controller is powered on, information on the software self-decompression will appear on the terminal display.

4.2.4 Startup Process



When the wireless controller is started for the first time, the following information appears:

```
*****
Boot 1.2.0-00346-g2d7093f (Build time: Mar 27 2014 - 16:04:49)

DRAM: 2 GiB
NAND: 512 MiB
Flash: 8 MiB
SETMAC: Setmac operation was performed at 2014-04-22 10:38:33 (version: 11.0)
Press Ctrl+C to enter Boot Menu
Bootloader: Done loading app on coremask: 0xffffffff
[ 0.000000] Linux version 2.6.32.13-Cavium-Octeon (ngcf@ngcf75) (gcc version 4.3.3 (Cavium Networks Version:
2_0_0 build 95) ) #1 SMP Thu May 8 04:34:42 CST 2014
[ 0.000000] CVMSEG size: 2 cache lines (256 bytes)
[ 0.000000] Cavium Inc. SDK-2.3
[ 0.000000] bootconsole [early0] enabled
[ 0.000000] CPU revision is: 000d910a (Cavium Octeon II)
[ 0.000000] Checking for the multiply/shift bug... no.
```

```
[ 0.000000] Checking for the daddiu bug... no.
[ 0.000000] Determined physical RAM map:
[ 0.000000] memory: 000000000003f000 @ 0000000000dd1000 (usable after init)
[ 0.000000] memory: 000000000f000000 @ 0000000000f00000 (usable)
[ 0.000000] memory: 00000000d0000000 @ 0000000020000000 (usable)
[ 0.000000] memory: 00000000ffff000 @ 00000000f0001000 (usable)
[ 0.000000] memory: 000000030efff000 @ 0000000100001000 (usable)
mount: Mounting /dev/sdal on /var/storage failed: No such device or address
Starting rg_lowmem_killer... [ OK ]
.....
Starting snooping.elf... [ OK ]
Starting postgresql server...
/mnt/sata0/pgsql/bin/postgres not found... [ OK ]
Starting rg-mtdoops-cli... [ OK ]
Starting sntp.elf... [ OK ]
Press RETURN to get started
*May 15 11:08:01: %CAPWAP-4-NO_IP_ADDR: Please config the IP address for capwap.
```

Now the wireless controller is ready for configuration.

-
-  Such information may vary with hardware configuration or software version.
 -  When using the wireless controller for the first time, it is recommended to set basic parameters during configuration.
-

4.3 Configuring Wireless Controller

See *RG-WLAN Series Access Controller RGOS Command Reference* and *RG-WLAN Series Access Controller RGOS Configuration Guide* for configuration details.

5 Troubleshooting

5.1 Power Troubleshooting

You may use the power indicator on the front panel to decide if the power supply system is operating normally. For description of indicators, see Chapter 1. If a fault occurs, check the following items:

- If RG-WS6008 power switch is in the on position.
- If the power supply is turned on.
- If the power cord is connected correctly.
- If the power supply meets the requirements.

 Never attempt hot swapping of the power cord. If the steps above did not solve your problem, contact your local distributor or technical support personnel.

5.2 System Troubleshooting

If the system is operational, relevant information is displayed on the terminal as described in chapter 4. Otherwise, nothing or gibberish is displayed. If nothing is displayed, please check the following items:

- Verify whether the system power supply is operational.
- Verify whether the cable is connected to the console port correctly.

If there is still nothing displayed, it may be due to improper cable connection or incorrect parameter settings. Please change the parameter settings.

If gibberish is displayed, it may be caused by incorrect parameter settings. Please check the following parameters:

- Baud rate: 9600
- Data bit: 8
- Parity check: None
- Stop bit: 1
- Flow control: None
- Terminal emulation: VT100

 If the console port parameters are changed, it may cause no display on the terminal.
