



# User Guide

## R2000 Dual

Industrial Dual Module Cellular VPN Router  
with Power over Ethernet



robustOS

Guangzhou Robustel Co, Ltd.

[www.robustel.com](http://www.robustel.com)

## About This Document

This document describes hardware and software of Robustel's R2000 Dual, an Industrial Dual Module Cellular VPN Router with Power over Ethernet.

**Copyright ©2022 Guangzhou Robustel Co., Ltd.**

**All rights reserved.**

## Trademarks and Permissions

 is trademark of Guangzhou Robustel Co., Ltd.. All other trademarks and trade names mentioned in this document are the property of their respective owners.

## Disclaimer

No part of this document may be reproduced in any form without the written permission of the copyright owner. The contents of this document are subject to change without notice due to continued progress in methodology, design and manufacturing. Robustel shall have no liability for any error or damage of any kind resulting from the inappropriate use of this document.

## Technical Support

Tel: +86-20-82321505

E-mail: [support@robustel.com](mailto:support@robustel.com)

Web: [www.robustel.com](http://www.robustel.com)

### Important Notice

Due to the nature of wireless communications, transmission and reception of data can never be guaranteed. Data may be delayed, corrupted (i.e., have errors) or be totally lost. Although significant delays or losses of data are rare when wireless devices such as the router is used in a normal manner with a well-constructed network, the router should not be used in situations where failure to transmit or receive data could result in damage of any kind to the user or any other party, including but not limited to personal injury, death, or loss of property. Robustel accepts no responsibility for damages of any kind resulting from delays or errors in data transmitted or received using the router, or for failure of the router to transmit or receive such data.

### Safety Precautions

#### General

- The router generates radio frequency (RF) power. When using the router, care must be taken on safety issues related to RF interference as well as regulations of RF equipment.
- Do not use your router in aircraft, hospitals, petrol stations or in places where using cellular products is prohibited.
- Be sure that the router will not be interfering with nearby equipment. For example: pacemakers or medical equipment. The antenna of the router should be away from computers, office equipment, home appliance, etc.
- An external antenna must be connected to the router for proper operation. Only uses approved antenna with the router. Please contact authorized distributor on finding an approved antenna.
- Always keep the antenna with minimum safety distance of 20 cm or more from human body. Do not put the antenna inside metallic box, containers, etc.
- RF exposure statements
  1. For mobile devices without co-location (the transmitting antenna is installed or located more than 20cm away from the body of user and nearby person)
- FCC RF Radiation Exposure Statement
  1. This Transmitter must not be co-located or operating in conjunction with any other antenna or transmitter.
  2. This equipment complies with FCC RF radiation exposure limits set forth for an uncontrolled environment. This equipment should be installed and operated with a minimum distance of 20 centimeters between the radiator and your body.

**Note:** Some airlines may permit the use of cellular phones while the aircraft is on the ground and the door is open. Router may be used at this time.

#### Using the router in vehicle

- Check for any regulation or law authorizing the use of cellular devices in vehicle in local country before installing the router.
- The driver or operator of any vehicle should not operate the route while driving.
- Install the router by qualified personnel. Consult your vehicle distributor for any possible interference of electronic parts by the router.
- The router should be connected to the vehicle's supply system by using a fuse-protected terminal in the vehicle's fuse box.
- Be careful when the router is powered by the vehicle's main battery. The battery may be drained after extended period.



### **Protecting your router**

To ensure error-free usage, please install and operate your router with care. Do remember the following:

- Do not expose the router to extreme conditions such as high humidity/rain, high temperature, direct sunlight, caustic/harsh chemicals, dust, or water.
- Do not try to disassemble or modify the router. There is no user serviceable part inside and the warranty would be void.
- Do not drop, hit or shake the router. Do not use the router under extreme vibrating conditions.
- Do not pull the antenna or power supply cable. Attach/detach by holding the connector.
- Connect the router only according to the instruction manual. Failure to do it will void the warranty.
- In case of problem, please contact authorized distributor.

## Regulatory and Type Approval Information

**Table 1:** Directives

2011/65/EU	<p>The European RoHS2.0 2011/65/EU Directive was issued by the European parliament and the European Council on 1 July 2011 on the restriction of the use of certain Hazardous substances in electrical and electronic equipment.</p> <p>On June 4, 2015, the Official Journal of the European Union published the RoHS2.0 Amendment Directive (EU)</p> <p>In 2015/863, four phthalates (DEHP, BBP, DBP, DIBP) were officially included in the list of restricted substances in Appendix II of RoHS 2.0 (2011/65/EU).</p> <p>From July 22, 2019, all electronic and electrical products exported to Europe (except medical and monitoring equipment) must meet this restriction; from July 22, 2021, medical equipment and monitoring equipment will also be included in the scope of control.</p>	
2012/19/EU	<p>The European WEEE 2012/19/EU Directive was issued by the European parliament and the European Council on 24 July 2012 on waste electrical and electronic equipment.</p>	
2013/56/EU	<p>The European 2013/56/EU Directive is a battery Directive which published in the EU official gazette on 10 December 2013. The button battery used in this product conforms to the standard of 2013/56/EU directive.</p>	

**Table 2:** Toxic or hazardous substances or elements with defined concentration limits

Name of the Part	Hazardous Substances									
	(Pb)	(Hg)	(Cd)	(Cr(VI))	(PBB)	(PBDE)	(DEHP)	(BBP)	(DBP)	(DIBP)
Metal parts	o	o	o	o	o	o	o	o	o	o
Circuit modules	o	o	o	o	o	o	o	o	o	o
Cables and cable assemblies	o	o	o	o	o	o	o	o	o	o
Plastic and polymeric parts	o	o	o	o	o	o	o	o	o	o
<p>o: Indicates that this toxic or hazardous substance contained in all of the homogeneous materials for this part is below the limit requirement in RoHS2.0.</p> <p>X: Indicates that this toxic or hazardous substance contained in at least one of the homogeneous materials for this part <i>might exceed</i> the limit requirement in RoHS2.0.</p>										

## Revision History

Updates between document versions are cumulative. Therefore, the latest document version contains all updates made to previous versions.

Date	Firmware Version	Document Version	Change Description
2016-06-06	2.0.0	v.1.0.0	<ul style="list-style-type: none"> <li>Initial Release</li> </ul>
2016-07-22	2.0.0	v.1.0.1	<ul style="list-style-type: none"> <li>Update contents: The product renderings, the dimension picture and the overview of interfaces;</li> <li>Add contents: POE Power Supply Adapter, RCM certification, Selection and Ordering Data</li> </ul>
2016-09-19	2.0.0	v.1.0.2	<ul style="list-style-type: none"> <li>Voltage range in Chapter 1.3 added;</li> <li>EMC in Chapter 1.3 changed;</li> <li>Updated Chapter 1.5;</li> <li>Chapter 2.7 and Chapter 2.10 added;</li> <li>First figure in Chapter 4.2.2 changed;</li> <li>Guangzhou area code changed to 20 and other minor changes made</li> </ul>
2016-11-11	2.0.0	v.1.0.3	<ul style="list-style-type: none"> <li>Updated section about 2.11 Power Supply.</li> </ul>
2017-02-09	2.0.0	v.1.0.4	<ul style="list-style-type: none"> <li>Changed Tel number to +86-20-29019902</li> <li>Changed CD information in Chapter 1.2</li> <li>Added illustration about connecting POE power supply in Chapter 2.11</li> </ul>
2017-04-25	2.0.0	v.1.0.5	<ul style="list-style-type: none"> <li>Updated ordering information in Chapter 1.5</li> </ul>
2018-06-04	2.0.0	v.1.0.6	<ul style="list-style-type: none"> <li>Revised power supply voltage range</li> </ul>
2018-06-28	2.0.0	v.1.0.7	<ul style="list-style-type: none"> <li>Revised the company name</li> </ul>
2019-01-30	2.0.0	v.1.0.8	<ul style="list-style-type: none"> <li>Revised the certifications</li> <li>Revised the Frequency bands of Wifi</li> </ul>
2019-09-17	2.0.0	v.1.0.9	<ul style="list-style-type: none"> <li>Revised the Regulatory and Type Approval Information</li> </ul>
2019-11-25	2.0.0	v.1.1.0	<ul style="list-style-type: none"> <li>Revised the description of Update firmware via tftp</li> </ul>
2022-01-18	2.0.0	v.1.1.1	<ul style="list-style-type: none"> <li>Revised the company name</li> <li>Revised <i>Regulatory and Type Approval Information</i></li> <li>Revised <i>Disclaimer</i></li> <li>Revised DI description and added <i>2.12 DI Wiring Diagram</i></li> <li>Deleted <i>Ordering Information</i></li> </ul>

## Contents

Chapter 1	Product Concept.....	9
1.1	Key Features.....	9
1.2	Package Contents.....	10
1.3	Specifications.....	12
1.4	Dimensions.....	13
Chapter 2	Hardware Installation.....	14
2.1	Overview.....	14
2.2	LEDs.....	15
2.3	Reset Button.....	16
2.4	Ethernet Ports.....	16
2.5	Insert or Remove SIM Card.....	16
2.6	Attach External Antenna (SMA Type).....	17
2.7	Mount the Router.....	17
2.8	Ground the Router.....	18
2.9	POE Connection.....	18
2.10	Connect the Router to the PC.....	19
2.11	Power Supply.....	19
2.12	DI Wiring Diagram.....	20
Chapter 3	Initial Configuration.....	21
3.1	Configure the PC.....	21
3.2	Factory Default Settings.....	24
3.3	Log in the Router.....	24
3.4	Control Panel.....	25
3.5	Status.....	27
3.6	Interface > Link Manager.....	28
3.7	Interface > LAN.....	38
3.8	Interface > Ethernet.....	42
3.9	Interface > Cellular.....	44
3.10	Interface > WiFi.....	47
3.11	Network > Route.....	54
3.12	Network > Firewall.....	55
3.13	Network > IP Passthrough.....	58
3.14	VPN > IPsec.....	59
3.15	VPN > OpenVPN.....	65
3.16	VPN > GRE.....	72
3.17	Services > Syslog.....	73
3.18	Services > Event.....	74
3.19	Services > NTP.....	76
3.20	Services > SMS.....	77
3.21	Services > Email.....	79
3.22	Services > SSH.....	80
3.23	Services > Web Server.....	81

---

3.24	Services > Advanced.....	82
3.25	System > Debug.....	83
3.26	System > Update.....	84
3.27	System > APP Center.....	84
3.28	System > Tools.....	85
3.29	System > Profile.....	89
3.30	System > User Management.....	90
Chapter 4	Configuration Examples.....	92
4.1	Cellular.....	92
4.1.1	Cellular Backup.....	92
4.1.2	SMS Remote Control.....	94
4.2	Network.....	96
4.2.1	IPsec VPN.....	96
4.2.2	OPENVPN.....	101
4.2.3	GRE VPN.....	104
Chapter 5	CLI Introduction.....	106
5.1	What's CLI.....	106
5.2	How to Use CLI Configure Router.....	107
5.3	Commands Reference.....	113
Glossary.....		114



# Chapter 1 Product Concept

## 1.1 Key Features

Robustel's R2000 Dual Industrial Dual Module Cellular VPN Router with Power over Ethernet provides fast and reliable communication for monitoring and controlling remote equipment. The added new feature, Power over Ethernet, makes installing or expanding much simpler and cheaper for both power and data transmission.

- Embedded dual module supporting two SIM cards online simultaneously
- Four fast Ethernet LAN port supporting Power over Ethernet
- 12.95 W of POE/30 W of POE+ shared across the four LAN ports
- Supports Cellular, WAN, WLAN link backup and ICMP detection; also supports cold backup, warm backup and load balancing
- WAN - Static/PPPOE/DHCP Client
- Wi-Fi supporting AP mode and Client mode
- VPN tunnel - IPsec/OpenVPN/GRE/L2TP/PPTP/DMVPN
- Auto reboot via SMS/Timing
- Supports RobustLink (a centralized M2M management platform for remote monitoring, configuration and firmware upgrade)
- Management and upgrading via web user interface/
- SMS/CLI/RobustLink
- Supports various APP like QoS, DDNS, VRRP, Captive Portal, SNMP, WLAN multi, multi-language
- Easy wall or DIN rail mounting options

## 1.2 Package Contents

Before installing the R2000 Dual Router, verify the kit contents as following.

**\*The following pictures are just for illustration purposes only, not based on their actual sizes\***

- Robustel R2000 Dual Industrial Dual Module Cellular VPN Router with Power over Ethernet x 1



- 6-pin pluggable 3.5mm terminal block for power x 1



- Quick Start Guide with download link of other documents or tools x 1

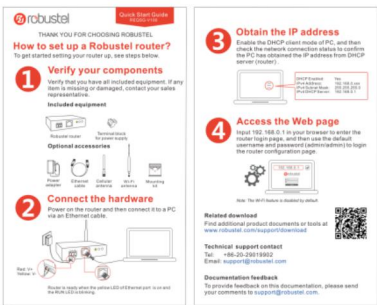

**\*If any of the above items is missing or damaged, please contact your Robustel sales representative\***

**Optional Accessories (sold separately):**

- SMA cellular antenna for 3G/4G LTE



- RP-SMA Wi-Fi antenna (Stubby antenna or magnet antenna optional)

Stubby antenna



Magnet antenna



- Ethernet cable



- Wall mounting kit

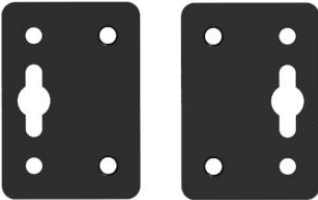

- 35 mm DIN rail mounting kit



- AC/DC power adapter (12V DC, 1.5 A; EU, US, UK, AU plug optional)



- POE power adapter

## 1.3 Specifications

### Cellular Interface

- Standards: GSM/GPRS/EDGE/UMTS/WCDMA/HSPA/HSDPA/HSUPA/HSPA+/DC-HSPA+/LTE
- FDD LTE: max. 150/50 Mbps (DL/UL) @20M BW cat4
- TDD LTE: max. 100/50 Mbps (DL/UL)
- DC-HSPA+: 42/5.76 Mbps (DL/UL)
- HSPA+: max. 21.6/5.76 Mbps (DL/UL)
- WCDMA: 384/384 kbps (DL/UL)
- EDGE: 236.8 kbps (DL/UL)
- GPRS: 85.6 kbps (DL/UL)
- SIM: 2 x Mini SIM (2FF)
- Connector: SMA, female (2 x MAIN + 2 x AUX)

### Ethernet Interface

- Number of ports: 1 x WAN and 4 x LAN (10/100 Mbps)
- Magnet isolation protection: 1.5 KV

### Wi-Fi Interface

- Standards: 802.11b/g/n, supporting AP and Client mode
- Data speed: 150 Mbps
- Frequency band: 2.4 GHz
- Security: WEP, WPA, WPA2
- Encryption: 64/128 AES, TKIP
- Connector: RP-SMA, female

### Other Interfaces

- POE (4 x LAN): Four ports power supply output  
IEEE802.3 at/af standard compatibility  
Maximum power output: up to 30 W per port  
Power management function: Voltage Range: 48 ~ 57 VDC
- Digital Input (DI): Level: 5 ~ 30 VDC = HIGH, 0 ~ 1 VDC = LOW  
Absolute maximum VDC: 30V

### Others

- Reset button: 1 x RST
- LED indicators: 1 x RUN, 2 x PPP, 1 x USR, 2 x NET, 6 x RSSI

### Software

- Network protocols: PPP, TCP, UDP, DHCP, ICMP, NAT, DMZ, DDNS, VRRP, HTTP, HTTPS, DNS, ARP, SNTP, SSH, Telnet, SNMP, AAA etc.
- VPN tunnel: IPSec/OpenVPN/GRE/L2TP/PPTP/DMVPN
- Firewall: SPI, anti-DoS, Filter, Access Control
- Management: Web, SMS, CLI

### Power Supply and Consumption

- Connector: 3.5 mm terminal block
- Input voltage: 9 ~ 57 VDC
- Power consumption: Idle: 100 mA@12 V  
Data link: 800 mA (peak)@12 V
- With ground screw

### SDK

- Supported programming language: C, C++
- Flash available for SDK: 4 MB
- RAM available for SDK: 16 MB

### Physical Characteristics

- Housing & Weight: Metal, 750 g
- Dimensions: 145 x 130 x 46 mm
- Installations: Desktop, wall mounting and 35 mm DIN rail mounting

### Regulatory and Type Approvals

- Environmental: RoHS2.0, WEEE
- EMI:EN 55032: 2015/AC: 2016 (CE & RE) Class B
- EMS:IEC 61000-4-2 (ESD) connect level2; Air level3  
IEC 61000-4-3 (RS) Level 2  
IEC 61000-4-4 (EFT) Level 2  
IEC 61000-4-5 (Surge) Level 3  
IEC 61000-4-6 (CS) Level 2

## 1.4 Dimensions

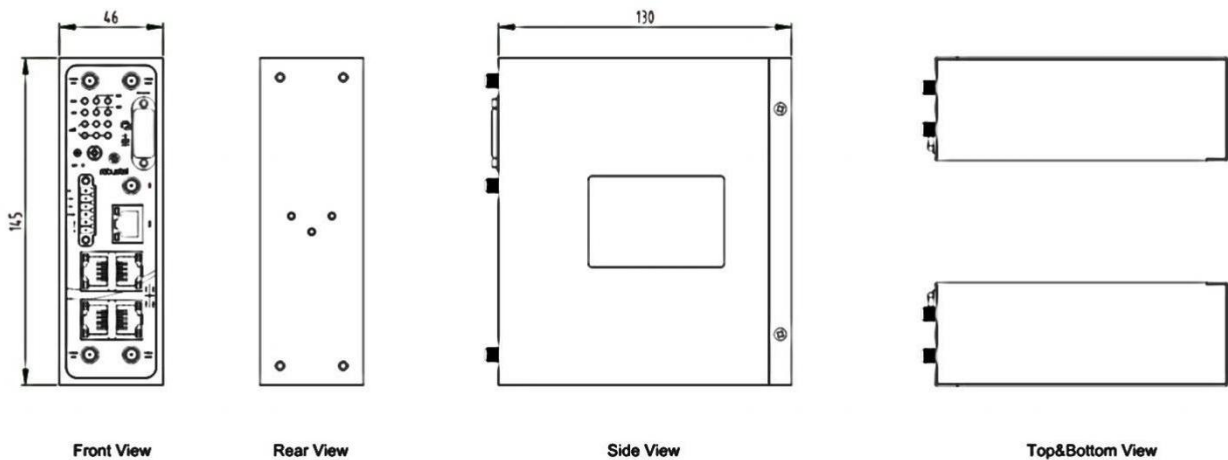

# Chapter 2 Hardware Installation

## 2.1 Overview

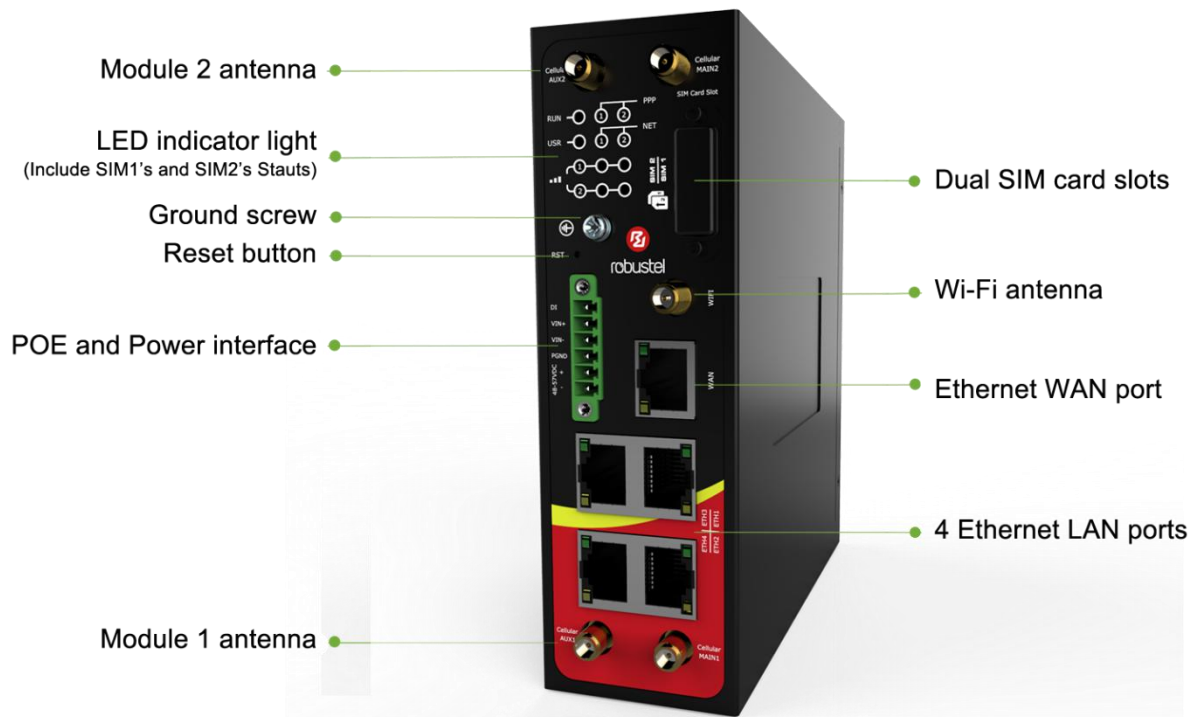

## 2.2 LEDs

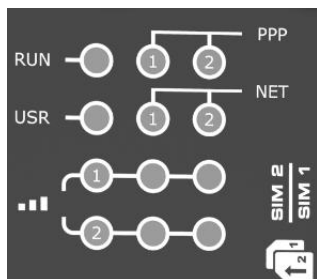

Name	Color	State	Description
RUN	Green	On, 1/2 sec blink	Router is ready.
		On, 1 sec blink	Router is booting.
		Off	Router is powered off.
PPP	Green	LED 1 is on	SIM1 PPP connection is working.
		LED 2 is on	SIM2 PPP connection is working.
USR	Green	On	OpenVPN: OpenVPN is connected. IPsec: IPsec is connected. Wi-Fi: Wi-Fi is connected.
		Off	OpenVPN: OpenVPN is disconnected. IPsec: IPsec is disconnected. Wi-Fi: Wi-Fi is disconnected.
NET (LED 1 stands for SIM 1, LED 2 stands for SIM 2)	Green	On, blinking green	Unable to connect to the best network. E.g. When R2000 Dual uses the 4G SIM card but cannot connect to the 4G network, the NET LED will always blink. The condition of 3G and 2G network will, too.
		On, solid green	Connect to the best network. E.g. When R2000 Dual uses the 4G SIM card and connects to the 4G network, the NET LED will turn to solid green. The condition of 3G and 2G network will, too.
		Off	Unable to access any network.
Signal Strength (Light 1 stands for SIM 1, light 2 stands for SIM 2)	Green	All LEDs are on	Signal level: 21-31 (Optimum signal level)
	Green	Two LEDs are on	Signal level: 11-20 (Average signal level)
	Green	Only one LED is on	Signal level: 1-10 (Abnormal signal level)
	When the network disconnected, those three signal LEDs are designed as a binary combination code to indicate a series of error report. On: 1 Off: 0 001 AT command failed 010 No SIM card detected 011 Need to enter the PIN code 100 Need to enter the PUK code 101 Registration failed 110 Something wrong happened in the module		

**Note:** User can choose the display status of USR LED. For more details please refer to **3.24 Service > Advanced**.

## 2.3 Reset Button

Function	Operation
Reboot	Press and hold the Reset button for at least 2~7 seconds under the operating status.
Restore to factory default settings	Wait for 5 seconds after powering up the router, press and hold the Reset button by a small non-conductive stick with a blunt end until all twelve LEDs blinking one by one, and release the button within 5 second to return the router to factory defaults.

## 2.4 Ethernet Ports

R2000 Dual Router has five Ethernet ports. Eth0 is a WAN port and Eth1~Eth4 are LAN ports supporting POE feature. Every Ethernet port has two LED indicators, while each indicator has three states. The yellow one is **Link Indicator** and the green one doesn't mean anything. For details see the table below.

Indicator	State	Description
Link Indicator	On	Connection is working
	On, blinking	Data is being transmitted
	Off	Connection is not working

## 2.5 Insert or Remove SIM Card

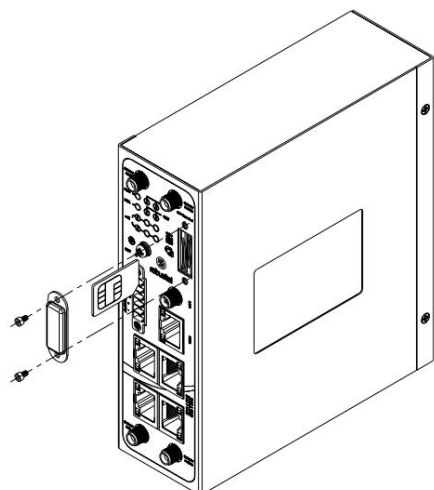

- **Insert SIM Card**

1. Make sure the router is powered off.
2. To remove slot cover, loosen the screws associated with the cover by using a screwdriver and then find the SIM card slot.
3. To insert SIM card, press the card with fingers until snap on and then tighten the screws associated with the cover by using a screwdriver.



- **Remove SIM Card**

1. Make sure the router is powered off.
2. To remove SIM card, press the card with fingers until pop out and then take out the SIM card.
3. Put back the slot cover and tighten the screws associated with the cover by using a screwdriver.

**Note:**

1. Recommended torque for inserting is 0.5 N.m, and the maximum allowed is 0.7 N.m.
2. Use the specific M2M SIM card when the device is working in extreme temperature (temperature exceeding 0-40 °C ), because the regular SIM card for long-time working in harsh environment (temperature exceeding 0-40°C) will be disconnected frequently.
3. Do not forget to twist the cover tightly to avoid being stolen.
4. Do not touch the metal of the SIM card surface in case information in the card will lost or be destroyed.
5. Do not bend or scratch the SIM card.
6. Keep the SIM card away from electricity and magnetism.
7. Make sure router is powered off before inserting or removing the SIM card.

## 2.6 Attach External Antenna (SMA Type)

Connect the SMA external antenna connector to the router's antenna interface and twist tightly.

Make sure the antenna is within the correct frequency range provided by the operator and with 50 Ohm impedance.

**Note:** Recommended torque for mounting is 0.35 N.m.

## 2.7 Mount the Router

The R2000 Dual Router supports flat surface placement, wall mounting and DIN rail mounting.

(unit: mm)

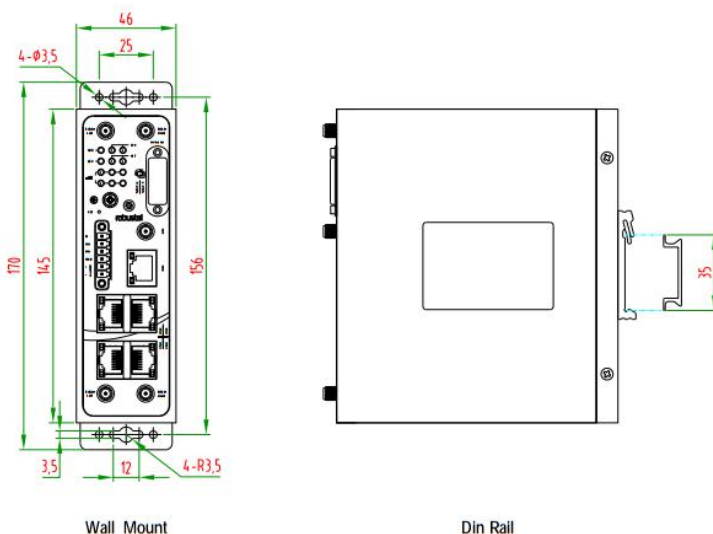

- **Two methods for mounting the router**

1. Wall mounting:

Use 4 pcs of M2.5\*4 flat head Phillips screws to fix the wall mounting kits to the router, and then use 2 pcs of M3 drywall screws to mount the router associated with the wall mounting kit on the wall.

**Note:** Recommended torque for mounting is 0.5 N.m, and the maximum allowed is 0.7 N.m.

2. DIN rail mounting:

Use 3 pcs of M3\*6 flat head Phillips screws to fix the DIN rail to the router, and then hang the DIN rail on the bracket. It is necessary to choose the standard bracket.

**Note:** Recommended torque for mounting is 1.0 N.m, and the maximum allowed is 1.2 N.m.

When mounting the kit onto the DIN rail, make sure that its metal springs are orientated towards the top of the DIN rail.

## 2.8 Ground the Router

Router grounding helps prevent the noise effect due to electromagnetic interference (EMI). Connect the router to the site ground wire by the ground screw before powering on.

**Note:** This product is appropriate to be mounted on a sound grounded device surface, such as a metal panel.

## 2.9 POE Connection

R2000 Dual's four fast Ethernet LAN ports support POE feature (Voltage range: 48 ~ 57 VDC), which can electrify the network terminal devices such as IP camera and other WLAN AP etc. See figure below for more details.

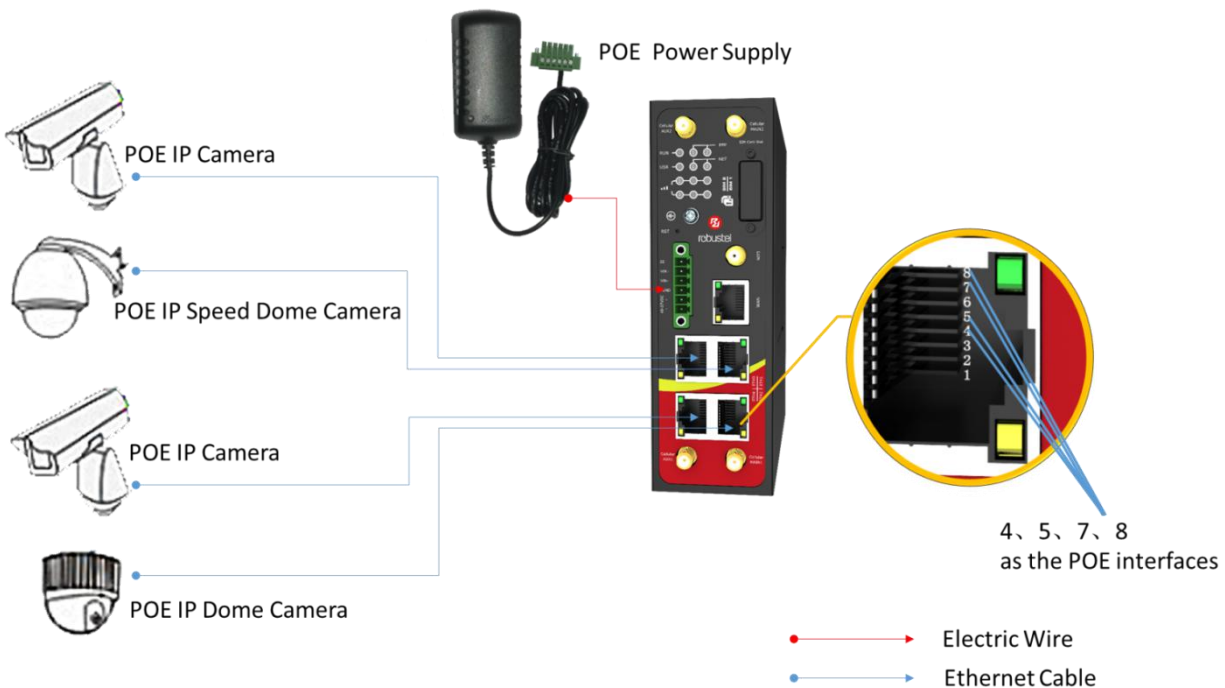

## 2.10 Connect the Router to the PC

Connect the router’s Ethernet port (Eth1/Eth2/Eth3/Eth4) to a PC via a standard cross-over cable.



## 2.11 Power Supply

R2000 Dual Router supports reverse polarity protection, but always refers to the figure below to connect the power adapter correctly. There are two cables associated with the power adapter. Following to the color of the head, connect the cable marked red to the positive pole through a terminal block, and connect the yellow one to the negative in the same way.

**Note:** The range of power voltage is 9 to 57V DC.

### CONNECTING THE REGULAR POWER SUPPLY

COLOR	POLARITY
RED	+
YELLOW	-

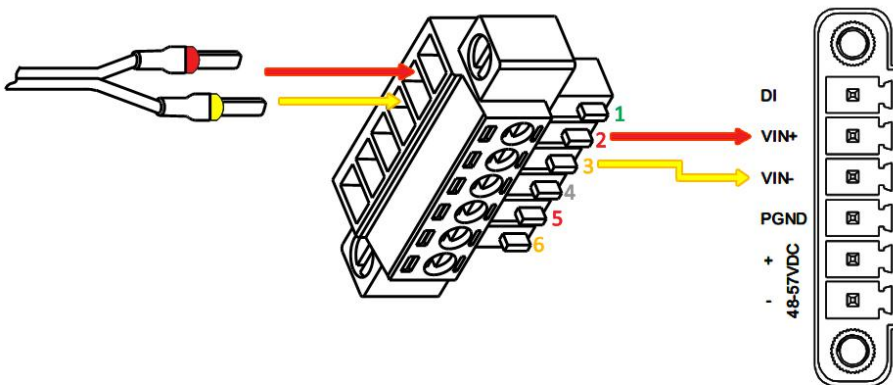

R2000 Dual Router also supports POE feature. Please refer to the figure below to connect the power adapter

correctly.

**Note:** The range of power voltage is 48 to 57V DC.

### CONNECTING THE POE POWER SUPPLY

PIN	NAME
1	DI
2	VIN+
3	VIN-
4	PGND
5	POE+
6	POE-

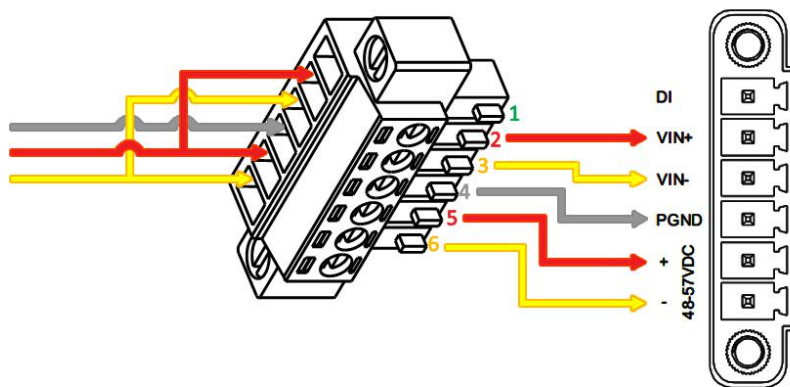

### 2.12 DI Wiring Diagram



## Chapter 3 Initial Configuration

The router can be configured through your web browser that including IE 8.0 or above, Chrome and Firefox, etc. A web browser is included as a standard application in the following operating systems: Linux, Mac OS, Windows 98/NT/2000/XP/Me/Vista/7/8, etc. It provides an easy and user-friendly interface for configuration. There are various ways to connect to the router, either through an external repeater/hub or connect directly to your PC. However, make sure that your PC has an Ethernet interface properly installed prior to connecting the router. You must configure your PC to obtain an IP address through a DHCP server or a fixed IP address that must be in the same subnet as the router. If you have any problems accessing the router web interface, it is advisable to uninstall your firewall program on your PC, as this tends to cause problems accessing the IP address of the router.

### 3.1 Configure the PC

There are two methods to obtain IP address for the PC, one is to obtain an IP address automatically from Local Area Connection, and another is to configure a static IP address manually within the same subnet of the router. Please refer to the steps below.

Here take **Windows 7** as example, and the configuration for windows system is similar.

1. Go to **Start > Control Panel**, double-click **Network and Sharing Center**, and then double-click **Local Area Connection**.

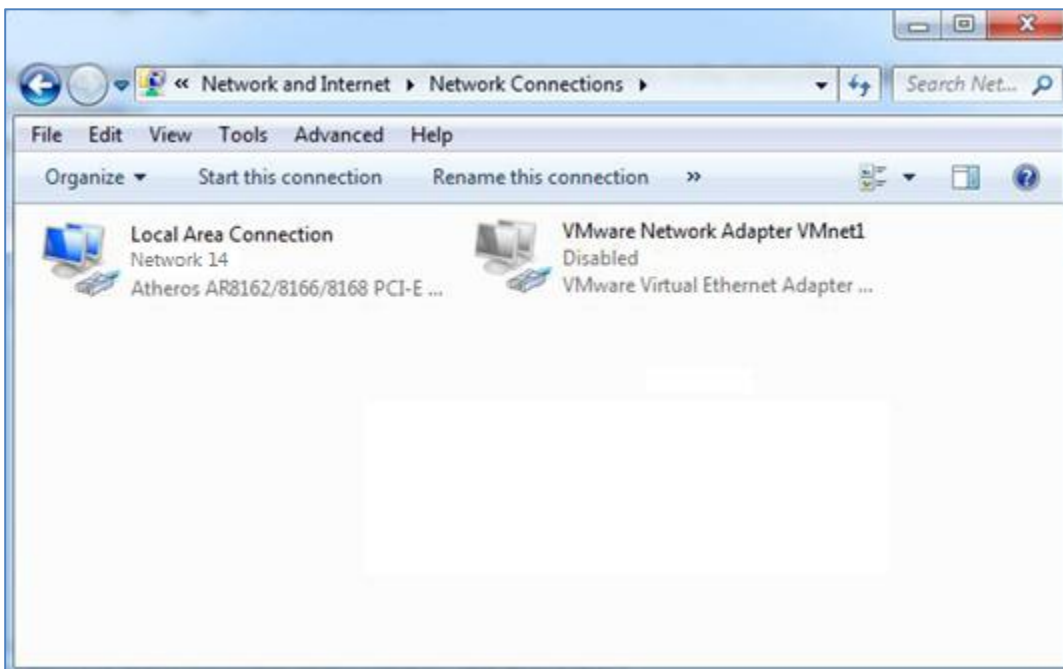

2. Click **Properties** in the window of **Local Area Connection Status**.

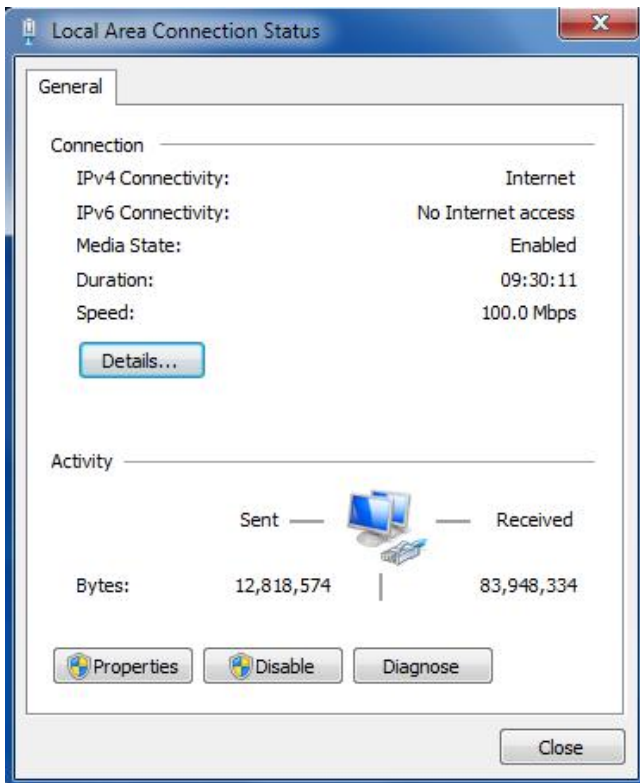

3. Choose **Internet Protocol Version 4 (TCP/IPv4)** and click **Properties**.

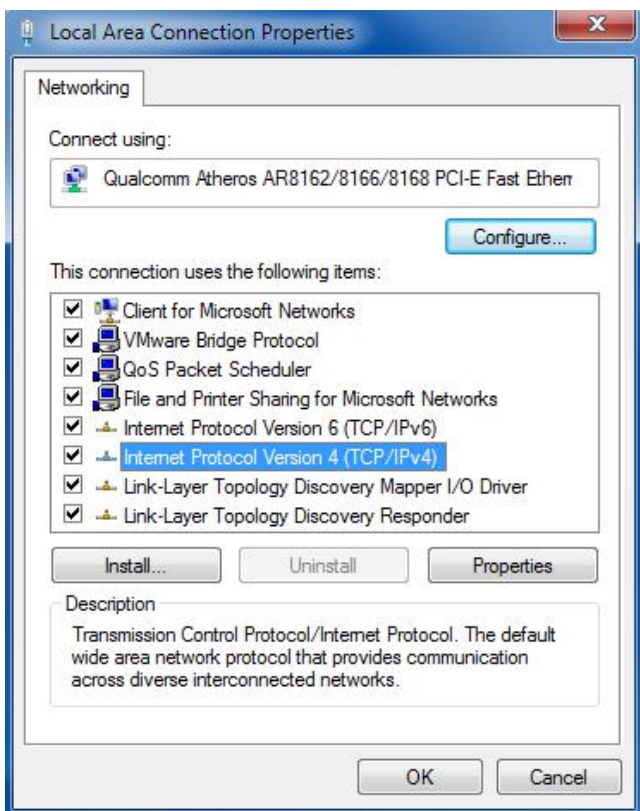

#### 4. Two ways for configuring the IP address of PC:

##### Obtain an IP address automatically:

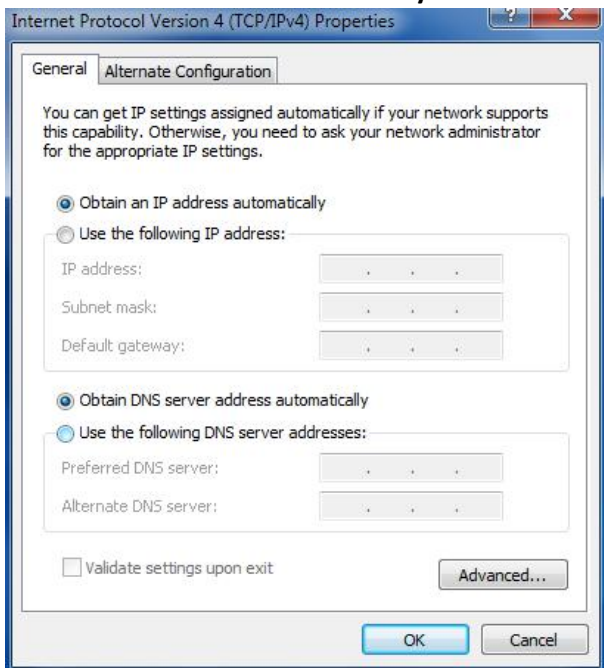

**Use the following IP address** (configured a static IP address manually within the same subnet of R2000 Dual Router):

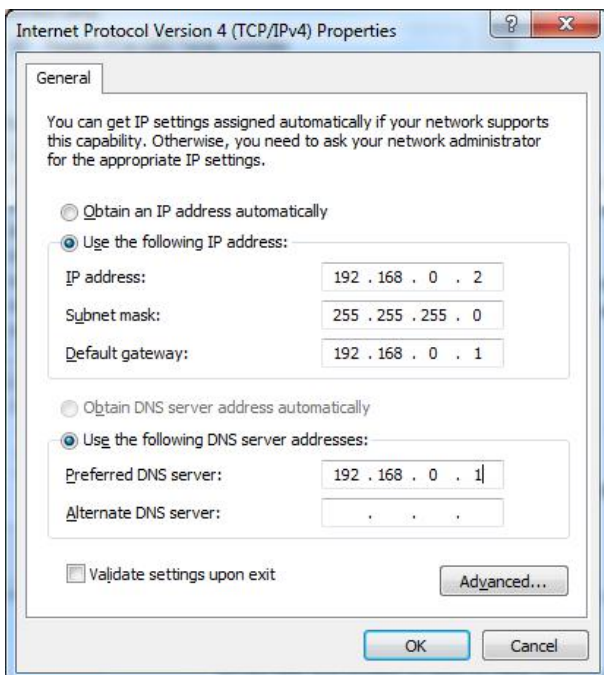

#### 5. Click **OK** to finish the configuration.



## 3.2 Factory Default Settings

Before configuring your router, you need to know the following default settings.

Item	Description
Username	admin
Password	admin
Eth0	DHCP
Eth1	192.168.0.1/255.255.255.0, lan0, DHCP Server Enabled.
Eth2	192.168.0.1/255.255.255.0, lan0, DHCP Server Enabled.
Eth3	192.168.0.1/255.255.255.0, lan0, DHCP Server Enabled.
Eth4	192.168.0.1/255.255.255.0, lan0, DHCP Server Enabled.

## 3.3 Log in the Router

1. On your PC, open a web browser such as Internet Explorer, Google and Firefox etc.
2. From your web browser, enter the IP address of the router. The default IP address of R2000 Dual Router is 192.168.0.1, though the actual address may vary.

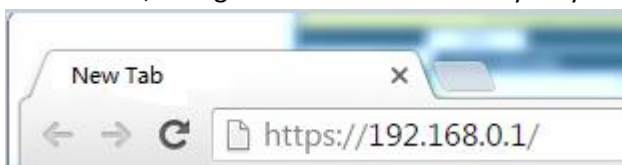

3. In the login page, enter the username and password, choose language and then click **LOGIN**.  
**Note:** If enter the wrong username or password over six times, the login web will be locked for 5 minutes.

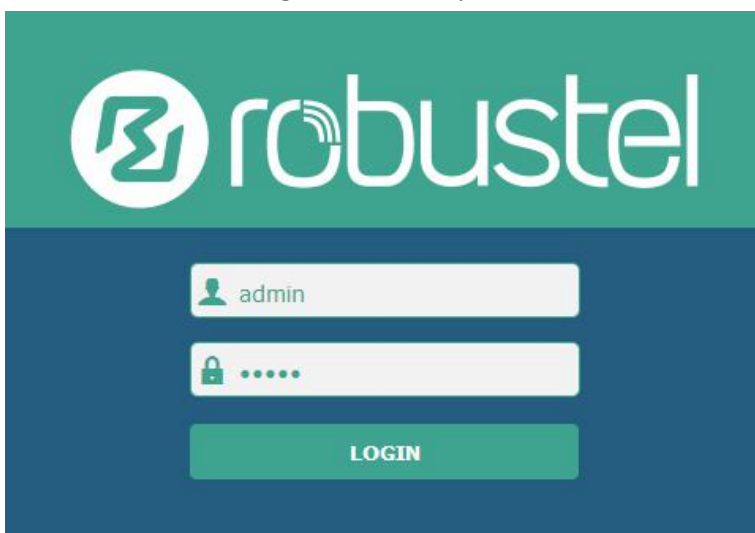



### 3.4 Control Panel

After logging in the R2000 Dual, the home page of the R2000 Lite router's web interface is displayed, for example.



robustel Save & Apply Reboot Logout

It is strongly recommended to change the default password.

Status

System Information

Device Model	R2000
System Uptime	0 days, 00:05:34
System Time	Wed Dec 16 10:12:28 2015
Firmware Version	1.2.0 (Rev 399)
Hardware Version	1.0
Kernel Version	3.10.49
Serial Number	15090140040008

Cellular Information

Modem Status	Ready
Model	ME909s-821
Firmware Version	11.617.00.00.00
IMEI	867223020050860
SIM Status	SIM2 using, total 1 SIMs
Network Registration	Registered to home network
Network Operator	CHN-UNICOM



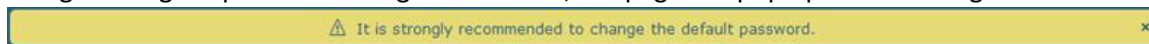

Copyright © 2015 Robustel Technologies. All rights reserved.

Using the original password to log in the router, the page will pop up the following tab





It is strongly recommended to change the default password.

click  to close the pop-up tab. If you want to change the password, please refer to **3.30 System > User Management**.

Control Panel		
Item	Description	Button
Save & Apply	Click to save the current configuration into router's flash and apply the modification on every configuration page, to make the modification taking effect.	
Reboot	Click to reboot the router. If the Reboot button is yellow, it means that some completed configurations will take effect only after reboot.	
Logout	Click to exit safely, then it will switch to login page. Shut down web page directly without logout, the next one can login web on this browser without a password before timeout.	
Submit	Click to submit the modification on current configuration page.	
Cancel	Click to cancel the modification on current configuration page.	

**Note:** The steps of how to modify configuration are as bellow:

1. Modify in one page;
2. Click  under this page;
3. Modify in another page;
4. Click  under this page;
5. Complete all modification;
6. Click  .

## 3.5 Status

This section displays the router's status, which shows you a number of helpful information such as System Information, Internet Status and LAN Status.

### System Information

^ System Information	
<b>Device Model</b>	R2000 Dual
<b>System Uptime</b>	0 days, 00:06:21
<b>System Time</b>	Tue Jun 14 11:37:21 2016
<b>Firmware Version</b>	2.0.0 (Rev 271)
<b>Hardware Version</b>	1.1
<b>Kernel Version</b>	3.10.49
<b>Serial Number</b>	20160613
<b>Coprocessor Version</b>	2.00.00

System Information	
Item	Description
Device Model	Show the model name of this device.
System Uptime	Show how long the router has been working since power on.
System Time	Show the current system time.
Firmware Version	Show the current firmware version.
Hardware Version	Show the current hardware version.
Kernel Version	Show the current kernel version.
Serial Number	Show the serial number of this device.
Coprocessor Version	Show the coprocessor version.

### Internet Status

^ Internet Status	
<b>Active Link</b>	WWAN2
<b>Uptime</b>	0 days, 00:00:08
<b>IP Address</b>	10.97.229.173/255.255.255.252
<b>Gateway</b>	10.97.229.174
<b>DNS</b>	221.179.38.7 120.196.165.7

Internet Status	
Item	Description
Active Link	Show the current WAN link: WWAN1, WWAN2 or WAN.
Uptime	Show how long the current WAN have been working.
IP Address	Show the current WAN IP address.
Gateway	Show the current gateway.
DNS	Show the current primary DNS server and Secondary server.

## LAN Status

^ LAN Status

**IP Address** 172.16.99.11/255.255.0.0

**MAC Address** 34:FA:40:04:AD:67

LAN Status	
Item	Description
IP Address	Show the current IP Address and the Netmask.
MAC Address	Show the current MAC Address.

## 3.6 Interface > Link Manager

### Link Manager

R2000 Dual has two wireless modules, when configure WWAN1 and WWAN2 as data transmit link in Link Manager and both of two links are online, two wireless modules can transmit data at the same time. User can manage the link connection in this section.

Link Manager Status

^ General Settings

**Primary Link**  v ?

**Backup Link**  v

**Backup Mode**  v ?

**Emergency Reboot**  ON  OFF ?

### Link Manager

Item	Description	Default
Primary Link	Select from “WWAN1”, “WWAN2”, “WAN”, “WLAN”. WWAN1: Select to make SIM1 as the primary wireless link. <b>Note:</b> insert SIM card please refer to the installation quick guide. WWAN2: Select to make SIM2 as the primary wireless link. WAN: Select to make WAN Ethernet port as the primary link. WLAN: Select to make WLAN as the router’s primary link. <b>Note:</b> WLAN link available only if enable R2000 Dual as WiFi Client in <b>3.10 Interface &gt; WiFi</b> .	WWAN1
Backup Link	Select from “None”, “WWAN1”, “WWAN2”, “WAN”, “WLAN”. None: Do not select backup interface. WWAN1: Select to make SIM1 as backup wireless WAN. WWAN2: Select to make SIM2 as backup wireless WAN. WAN: Select to make WAN Ethernet port as the backup WAN. WLAN: Select to make WLAN as the router’s backup link. <b>Note:</b> WLAN link available only if enable R2000 Dual as WiFi Client in <b>3.10 Interface &gt; WiFi</b> .	None
Backup Mode	Cold backup: The inactive link is offline on standby. Warm backup: The inactive link is online on standby. Load balancing: Use both links at the same time.	Cold backup
Emergency Reboot	Enable to reboot the whole system if no links available.	OFF

**Note:** Click “” for help.

**Link Setting** section allows user to configure the parameter of link connection, include the WWAN1/WWAN2, WAN and WLAN.

It is recommended to enable Ping detection to keep router always online.

The Ping detection increases the reliability and also cost data traffic.

^ Link Settings			
Index	Description	Type	Connection Type
1		WWAN1	DHCP
2		WWAN2	DHCP
3		WAN	DHCP
4		WLAN	DHCP

Click  to enter the link configuration window.

## WWAN1/WWAN2

**Link Manager**

^ **General Settings**

Index

Type  v

Description

When enable “Automatic APN Selection”, the window will display just like the following screenshot.

^ **WWAN Settings**

**Automatic APN Selection**  ON  OFF

Dialup Number

Authentication Type  v

Aggressive Reset  ON  OFF ?

Switch SIM By Data Allowance  ON  OFF ?

Data Allowance  ?

Billing Day  ?

When disable “Automatic APN Selection”, the window will display just like the following screenshot.

^ **WWAN Settings**

**Automatic APN Selection**  ON  OFF

APN

Username

Password

Dialup Number

Authentication Type  v

Aggressive Reset  ON  OFF ?

Switch SIM By Data Allowance  ON  OFF ?

Data Allowance  ?

Billing Day  ?

WWAN Setting		
Item	Description	Default

WWAN Setting		
Item	Description	Default
Automatic APN Selection ON	ON: R2000 Dual will recognize the access point name automatically.	ON
Dialup Number	Dialup number for cellular dial-up connection, provided by local ISP.	*99***1#
Authentication Type	Select from "Auto", "PAP" and "CHAP" as the local ISP required.	Auto
Aggressive Reset	The module will be reset when the link become unreachable.	OFF
Switch SIM By Data Allowance	Switch to another SIM when reach data allowance, only use for dual SIM backup.	OFF
Data Allowance	Set the monthly data traffic limitation. The system will record the data traffic statistics when data traffic limitation (MiB) is specified. The traffic record will display in <b>Link Manager &gt; Status &gt; WWAN Data Usage Statistics</b> . 0 means disable data traffic record.	0
Billing Day	This option specifies the day of month for billing, the data traffic statistics will be recalculated from this day.	1
Redial Interval	Seconds to wait for redial.	10
Automatic APN Selection OFF	OFF: Select access point name manually.	/
APN	Access Point Name for cellular dial-up connection, provided by local ISP.	internet
Username	User Name for cellular dial-up connection, provided by local ISP.	Null
Password	Password for cellular dial-up connection, provided by local ISP.	Null

^ Ping Detection Settings
?

Enable  OFF

Primary Server

Secondary Server

Interval  ?

Retry Interval  ?

Timeout  ?

Max Ping Tries  ?

^ Advanced Settings

Weight  ?

Upload Bandwidth  ?

Download Bandwidth

Overridden Primary DNS

Overridden Secondary DNS

**Ping Detection Settings/Advanced Setting**



Item	Description	Default
Enable	To enable “ping detection”. It was a keepalive policy of R2000 Dual Router.	OFF
Primary Server	Router will ping this primary address/domain name to check that if the current connectivity is active.	8.8.8.8
Secondary Server	Router will ping this secondary address/domain name to check that if the current connectivity is active.	Null
Interval	Set the ping interval.	300
Retry Interval	Set the ping retry interval.	5
Timeout	Set the ping timeout.	3
Max Ping Tries	Switch to another link or take emergency action if max continuous ping tries reached.	3
Weight	Weight is available only under load balancing backup mode. Weight is the percent of usage traffic for the current link. Value range from 1 to 100.	1
Upload Bandwidth	used for QoS, unit: kbps	10000
Download Bandwidth	used for QoS, unit: kbps	10000
Overridden Primary DNS	Overridden DNS will override the automatically obtained DNS.	Null
Overridden Secondary DNS	Overridden DNS will override the automatically obtained DNS.	Null

## WAN

**Link Manager**

^ **General Settings**

**Index**

**Description**

**Type**  v

**Connection Type**  v

When choose the WAN Connection Type as DHCP, R2000 Dual will obtain IP automatically from DHCP server.  
When choose the WAN Connection Type as Static.

^ **Static Address Settings**

**IP Address**  ?

**Gateway**

**Primary DNS**

**Secondary DNS**

Static		
Item	Description	Default



Static		
Item	Description	Default
IP Address	Set the IP address with Netmask which can access the internet. IP address with Netmask, e.g. 192.168.1.1/24	Null
Gateway	Set the gateway of the WAN IP.	Null
Primary DNS	Set the Primary DNS.	Null
Secondary DNS	Set the Secondary DNS.	Null

When choose the WAN Connection Type as PPPoE.

**^ PPPoE Settings**

**Username**

**Password**

**Authentication Type**  v

**PPP Expert Options**  ?

PPPoE		
Item	Description	Default
Username	Enter the username which was provided by your Internet Service Provider.	Null
Password	Enter the password which was provided by your Internet Service Provider.	Null
Authentication Type	Select from "Auto", "PAP" and "CHAP" as the local ISP required.	Auto
PPP Expert Options	PPP Expert options used for PPPoE dialup. You can enter some other PPP initialization strings in this field. Each string can be separated by a semicolon.	Null

**^ Ping Detection Settings** ?

**Enable**  ON  OFF

**Primary Server**

**Secondary Server**

**Interval**  ?

**Retry Interval**  ?

**Timeout**  ?

**Max Ping Tries**  ?

^ **Advanced Settings**

**Weight**

**Upload Bandwidth**

**Download Bandwidth**

**Overridden Primary DNS**

**Overridden Secondary DNS**

?  
 ?

Ping Detection Setting/Advance Setting		
Item	Description	Default
Enable	To enable “ping detection”. It was a keepalive policy of R2000 Dual Router.	OFF
Primary Server	Router will ping this primary address/domain name to check that if the current connectivity is active.	8.8.8.8
Secondary Server	Router will ping this secondary address/domain name to check that if the current connectivity is active.	Null
Interval	Set the ping interval.	300
Retry Interval	Set the ping retry interval.	5
Timeout	Set the ping timeout.	3
Max Ping Tries	Switch to another link or take emergency action if max continuous ping tries reached.	3
MTU	Maximum Transmission Unit. It is the identifier of the maximum size of packet, which is possible to transfer in a given environment.	1500
Weight	Weight is available only under load balancing backup mode. Weight is the percent of usage traffic for the current link. Value range from 1 to 100.	1
Upload Bandwidth	used for QoS, unit: kbps	10000
Download Bandwidth	used for QoS, unit: kbps	10000
Overridden Primary DNS	Overridden DNS will override the automatically obtained DNS.	Null
Overridden Secondary DNS	Overridden DNS will override the automatically obtained DNS.	Null

## WLAN

**Link Manager**

^ **General Settings**

**Index**

**Description**

**Type**

**Connection Type**

v  
 v

When choose the WLAN Connection Type as DHCP, R2000 Dual will obtain IP automatically from the WLAN AP.

Complete the SSID parameters configuration in the window below.

WLAN Settings

SSID: R2000

Connect to Hidden SSID: OFF

Password: .....

Debug Level: none

WLAN Setting		
Item	Description	Default
SSID	Enter SSID of the access point which R2000 Dual want to connect. Input from 1 to 32 characters.	router
Connect to Hidden SSID	When R2000 Dual works as Client mode and need to connect to any access point which has hidden SSID, you need to enable this feature.	OFF
Password	Enter access point's passphrase which it wants to connect to. Input from 8 to 63 characters.	Null
Debug Level	Select from "verbose", "debug", "info", "notice", "warning", "none".	None

When choose the WLAN Connection Type as Static. Please enter the related parameter in the **Static Address Setting** window.

Static Address Settings

IP Address: [ ] ?

Gateway: [ ]

Primary DNS: [ ]

Secondary DNS: [ ]

Static Address Setting		
Item	Description	Default
IP Address	Enter the IP address which was identified by the WiFi AP. IP address with Netmask, e.g. 192.168.1.1/24	Null
Gateway	Enter the WiFi AP's IP address.	Null
Primary DNS	Enter the primary DNS server IP address.	Null
Secondary DNS	Enter the Secondary DNS server IP address.	Null

R2000 Dual Router cannot support PPPoE WLAN Connection Type.

^ Ping Detection Settings
?

Enable  ON  OFF

Primary Server

Secondary Server

Interval  ?

Retry Interval  ?

Timeout  ?

Max Ping Tries  ?

---

^ Advanced Settings

Weight  ?

Upload Bandwidth  ?

Download Bandwidth

Overridden Primary DNS

Overridden Secondary DNS

Ping Detection Setting/Advance Setting		
Item	Description	Default
Enable	To enable “ping detection”. It was a keepalive policy of R2000 Dual Router.	OFF
Primary Server	Router will ping this primary address/domain name to check that if the current connectivity is active.	8.8.8.8
Secondary Server	Router will ping this secondary address/domain name to check that if the current connectivity is active.	Null
Interval	Set the ping interval.	300
Retry Interval	Set the ping retry interval.	5
Timeout	Set the ping timeout.	3
Max Ping Tries	Switch to another link or take emergency action if max continuous ping tries reached.	3
MTU	Maximum Transmission Unit. It is the identifier of the maximum size of packet, which is possible to transfer in a given environment.	1500
Weight	Weight is available only under load balancing backup mode. Weight is the percent of usage traffic for the current link. Value range from 1 to 100.	1
Upload Bandwidth	used for QoS, unit: kbps	10000
Download Bandwidth	used for QoS, unit: kbps	10000
Overridden Primary DNS	Overridden DNS will override the automatically obtained DNS.	Null
Overridden Secondary DNS	Overridden DNS will override the automatically obtained DNS.	Null

## Status

Link Manager		Status		
<b>^ Link Status</b> <span style="float: right;">⋮</span>				
Index	Link	Status	Uptime	IP Address
1	WLAN	Connected	0 days, 00:00:10	192.168.1.12...

Click the button  which is in the top right of the Link Status window. Select the connection status of the current link.



Click the row of the link, and it will show the details information of the current link connection under the row.

Link Manager		Status		
<b>^ Link Status</b> <span style="float: right;">⋮</span>				
Index	Link	Status	Uptime	IP Address
1	WLAN	Connected	0 days, 00:00:10	192.168.1.12...
<div style="text-align: right; padding-right: 20px;"> <b>Index</b> 1  <b>Link</b> WLAN  <b>Status</b> Connected  <b>Uptime</b> 0 days, 00:00:10  <b>IP Address</b> 192.168.1.123/255.255.255.0  <b>Gateway</b> 192.168.1.1  <b>DNS</b> 192.168.1.1  <b>RX Packets</b> 1200  <b>TX Packets</b> 399  <b>RX Bytes</b> 165023  <b>TX Bytes</b> 106140                 </div>				

^ WWAN Data Usage Statistics	
SIM1 Monthly Stats	<b>Clear</b>
SIM2 Monthly Stats	<b>Clear</b>

Click **Clear** button to clear SIM1 or SIM2 monthly data traffic usage statistics. Data statistics will display only if enable the Data Allowance function in **Link Manager > Link Setting > WWAN Setting**.

### 3.7 Interface > LAN

This section allows user to set the LAN and the related parameters.

#### LAN

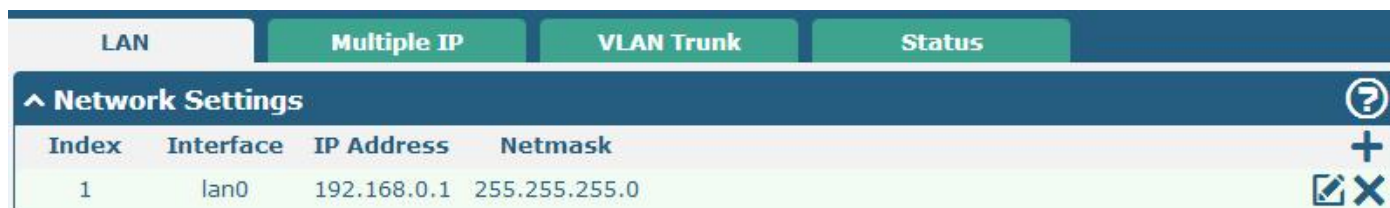

Click to edit the configuration of the current LAN interface. Click to delete the current LAN interface. Click to add a new LAN interface. The maximum number of LAN interface is four which include lan0, lan1, lan2 and lan3.

Lan0~lan3 is available when they were selected randomly by ETH1~ETH4 in **3.8 Interface > Ethernet** section. All of ETH1~ETH4 were default to lan0, and the default IP is 192.168.0.1/255.255.255.0.

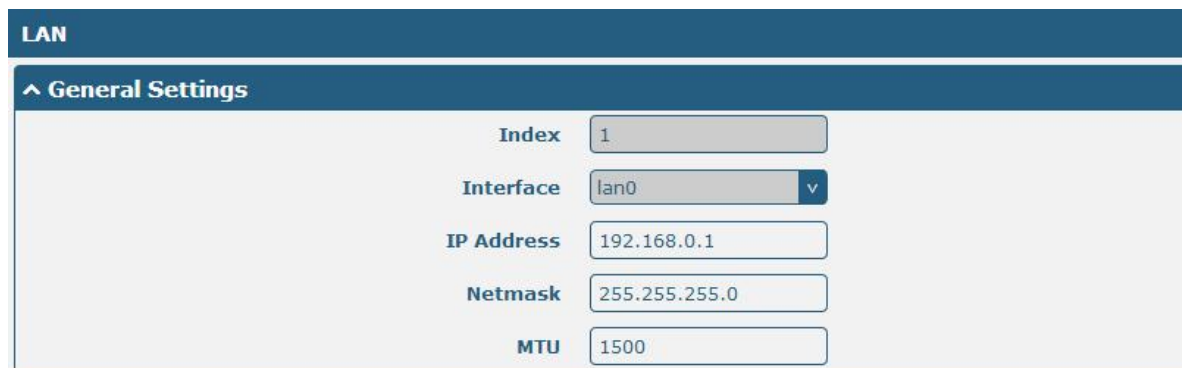

General Settings		
Item	Description	Default
Interface	Select from wan or lan0 to lan3. Note: Lan0~lan3 is available when they were selected randomly by ETH1~ETH4 in <b>3.8 Interface &gt; Ethernet</b> section. All of ETH1~ETH4 were default to lan0, and the default IP is 192.168.0.1/255.255.255.0.	lan0
IP Address	Set the IP Address of the LAN interface.	192.168.0.1
Netmask	Set the Netmask of the LAN interface.	255.255.255.0
MTU	Maximum Transmission Unit. It is the identifier of the maximum size of packet, which is possible to transfer in a given environment.	1500

Enable DHCP function, when configure DHCP Mode as Server, the window will display as the following screenshot.

^ DHCP Settings

Enable  ON  OFF

Mode  v

IP Pool Start

IP Pool End

Subnet Mask

---

^ DHCP Advanced Settings

Gateway

Primary DNS

Secondary DNS

WINS Server

Lease Time  ?

Expert Options  ?

Debug Enable  ON  OFF

DHCP Server		
Item	Description	Default
Enable	Click the switch to show “ON” and to enable DHCP function.	ON
Mode	Server: Lease IP address to DHCP clients which connect to LAN. Relay: Router can be DHCP Relay, which will provide a relay tunnel to solve problem that DHCP Client and DHCP Server is not in a same subnet.	DHCP Server
IP Pool Start	Define the beginning of the pool of IP addresses which will lease to DHCP clients.	192.168.0.2
IP Pool End	Define the end of the pool of IP addresses which will lease to DHCP clients.	192.168.0.100
Subnet Mask	Define the Subnet Mask which the DHCP clients will obtain from DHCP server.	255.255.255.0
Gateway	Define the Gateway which the DHCP clients will obtain from DHCP server.	Null
Primary DNS	Define the Primary DNS Server which the DHCP clients will obtain from DHCP server.	Null
Secondary DNS	Define the Secondary DNS Server which the DHCP clients will obtain from DHCP server.	Null
WINS Server	Define the Windows Name Server which the DHCP clients will obtain from DHCP server.	Null
Lease Time	Define the time which the client can use the IP address which obtained from DHCP server.	120
Expert Options	You can enter some other options of DHCP server in this field. format: config-desc;config-desc, e.g. log-dhcp;quiet-dhcp	Null
Debug Enable	Enable this function; it will output the DHCP information to syslog.	OFF



When configure DHCP Mode as Relay, the window will display as the following screenshot.

^ DHCP Settings

Enable  ON  OFF

Mode Relay v

DHCP Server For Relay

^ DHCP Advanced Settings

Debug Enable  ON  OFF

DHCP Server		
Item	Description	Default
DHCP Server for Relay	Enter the DHCP Relay server IP address.	Null
Debug Enable	Enable this function; it will output the DHCP information to syslog.	OFF

## Multiple IP

^ Multiple IP Settings

Index	Interface	IP Address	Netmask	
1	lan0	172.16.99.67	255.255.0.0	<span style="font-size: 1.2em;">+</span> <span style="font-size: 1.2em;">✎ ✕</span>

Click ✎ to edit the Multiple IP of the LAN interface. Click ✕ to delete the Multiple IP of the LAN interface.  
 Click + to add a multiple IP to the LAN interface.

^ IP Settings

Index 1

Interface lan0 v

IP Address 172.16.99.67

Netmask 255.255.0.0

Multiple IP		
Item	Description	Default
Interface	Select from lan0 to lan3. Lan0~lan3 is available when they were selected randomly by ETH1~ETH4 in <b>3.8 Interface &gt; Ethernet</b> section. All of ETH1~ETH4 were default to lan0, and the default IP is 192.168.0.1/255.255.255.0.	lan0
IP Address	Set the multiple IP Address of the LAN interface.	Null
Netmask	Set the multiple Netmask of the LAN interface.	Null



## VLAN Trunk

LAN
Multiple IP
VLAN Trunk
Status

^ VLAN Settings

Index	Enable	Interface	VID	IP Address	Netmask	+
-------	--------	-----------	-----	------------	---------	---

Click **+** to add a VLAN. The maximum number of the VLAN is eight.

VLAN Trunk

^ VLAN Settings

Index

Enable  ON  OFF

Interface

VID

IP Address

Netmask

VLAN Trunk		
Item	Description	Default
Enable	Enable to make router can encapsulate and de-encapsulate the VLAN tag.	ON
Interface	Select from lan0 to lan3. Lan0~lan3 is available when they were selected randomly by ETH1~ETH4 in <b>3.8 Interface &gt; Ethernet</b> section. All of ETH1~ETH4 were default to lan0, and the default IP is 192.168.0.1/255.255.255.0.	lan0
VID	Set the Tag ID of VLAN, values range from 1 to 4094.	100
IP Address, Netmask	Set the IP address, Netmask of VLAN interface	Null

## Status

This section shows the Ethernet port status and connected devices.

LAN	Multiple IP	VLAN Trunk	Status	
<b>^ Interface Status</b>				
Index	Interface	IP Address	MAC Address	
1	lan0	192.168.0.1/255.25..	34:FA:40:0D:8C:E9	
<b>^ Connected Devices</b>				
Index	IP Address	MAC Address	Interface	Inactive Time
1	192.168.0.55	50:7B:9D:63:18:17	lan0	0s
<b>^ DHCP Lease Table</b>				
Index	IP Address	MAC Address	Interface	Expired Time

Click every row, the details status information will be display under the row. Please refer to the screenshot below.

<b>^ Interface Status</b>			
Index	Interface	IP Address	MAC Address
1	lan0	192.168.0.1/255.2...	34:FA:40:0B:B9:E9
		<b>Index</b>	1
		<b>Interface</b>	lan0
		<b>IP Address</b>	192.168.0.1/255.255.255.0
		<b>MAC Address</b>	34:FA:40:0B:B9:E9
		<b>RX Packets</b>	0
		<b>TX Packets</b>	0
		<b>RX Bytes</b>	0
		<b>TX Bytes</b>	0
2	lan1	172.16.99.68/255....	34:FA:40:0B:E6:46

### 3.8 Interface > Ethernet

R2000 Dual has four LAN Ethernet ports and one WAN Ethernet port. This section allow user to set the parameter of all the Ethernet port.

One LAN Ethernet port should be assigned to lan0 a least. All of ETH1~ETH4 were default to lan0, and the default IP is 192.168.0.1/255.255.255.0. Please go to **3.7 Interface > LAN** to configure the LAN IP.

Only ETH0 can be assigned as wan. Please go to **3.6 Interface > Link Manager** to configure the WAN IP.

Ports		Status
<b>^ Port Settings</b>		
Index	Port	Port Assignment
1	eth0	wan
2	eth1	lan0
3	eth2	lan0
4	eth3	lan0
5	eth4	lan0

Click  button, configure the port setting.

**Ports**

**^ Port Settings**

Index:

Port:

Port Assignment:

POE Enable:  ON  OFF

Ethernet		
Item	Description	Default
Index	The index of Ethernet port, cannot edit.	/
Port	Select from ETH1 to ETH4. <b>Note:</b> Only ETH0 can be assigned as wan. One of ETH1~ETH4 port should be assigned to lan0 a least.	/
Port Assignment	Select from wan, lan0, lan1, lan2 and lan3. <b>Note:</b> Only ETH0 can be assigned as wan. Lan0~lan3 is available when they were selected randomly by ETH1~ETH4 in <b>3.8 Interface &gt; Ethernet</b> section. All of ETH1~ETH4 port can be assigned as the same lan. All of ETH1~ETH4 default to lan0, and the default IP is 192.168.0.1/255.255.255.0.	lan0
POE Enable	Click to enable or disable the POE function. When enable POE function and connect POE voltage, R2000 dual can supply power to the behind device via ETH1~ETH4. <b>Note:</b> ETH0 cannot support POE function.	ON

This section shows the link connection status of all the Ethernet port.

Ports			Status
<b>^ Port Status</b>			
Index	Port	Link	
1	eth0	Down	
2	eth1	Up	
3	eth2	Down	
4	eth3	Down	
5	eth4	Down	

Click the row of the Ethernet port, the details of the port will show below.

^ Port Status			
Index	Port	Link	
1	eth0	Down	
2	eth1	Up	
			<b>Index</b> 2 <b>Port</b> eth1 <b>Link</b> Up <b>POE Status</b> Power OFF <b>POE Voltage</b> 0.000 V <b>POE Current</b> 0.000 mA
3	eth2	Down	
4	eth3	Down	
5	eth4	Down	

### 3.9 Interface > Cellular

R2000 Dual has two wireless module, support two modules work in same time.

When it is the first time to insert single SIM card, SIM card 1 and SIM card 2 slots are available.

This section allows users to set the Cellular WAN and the related parameters.

Cellular		Status			
<b>^ Advanced Cellular Settings</b>					
Index	SIM Card	Phone Number	Network Type	Band Select Type	
1	SIM1		Auto	All	
2	SIM2		Auto	All	

Click  to edit the parameters.

**Cellular**

^ **General Settings**

Index	<input type="text" value="1"/>
SIM Card	<input style="border-bottom: 1px solid #ccc;" type="text" value="SIM1"/> v
Phone Number	<input type="text"/>
PIN Code	<input type="text"/> ?
Extra AT Cmd	<input type="text"/> ?
Telnet Port	<input type="text" value="0"/> ?

When choose “Network Type” is “Auto”;

^ **Cellular Network Settings**

Network Type	<input style="border-bottom: 1px solid #ccc;" type="text" value="Auto"/> v ?
Band Select Type	<input style="border-bottom: 1px solid #ccc;" type="text" value="All"/> v ?

When choose “band select type” is “Specify”.

^ **Cellular Network Settings**

Network Type	<input style="border-bottom: 1px solid #ccc;" type="text" value="Auto"/> v ?
Band Select Type	<input style="border-bottom: 1px solid #ccc;" type="text" value="Specify"/> v ?
GSM 900	<input type="checkbox"/> OFF
GSM 1800	<input type="checkbox"/> OFF
WCDMA 850	<input type="checkbox"/> OFF
WCDMA 900	<input type="checkbox"/> OFF
WCDMA 1900	<input type="checkbox"/> OFF
WCDMA 2100	<input type="checkbox"/> OFF

Cellular		
Item	Description	Default
Index	Show the index of the SIM.	1
SIM Card	Set the current SIM card.	SIM1
Link Name	Set the current Link Name.	WWAN1
Phone Number	Define the phone number of the SIM card.	Null
PIN Code	PIN code used to unlock the SIM card, 4-8 digits.	
Extra AT Cmd	AT commands used for cellular initialization.	Null
Telnet Port	Port listening for telnet service, used for AT over Telnet.	0
Network Type	Select from “Auto”, “2G Only”, “2G First”, “3G Only”, “3G First”, “4G Only”, “4G First”.	Auto

Cellular		
Item	Description	Default
Band Select Type	Select from "All", "Specify". When select "Specify", user can choose certain bands.	All

This section allow user to check the cellular status information.

Cellular				
Status				
^ Status				
Index	IMSI	Registration	Signal Strength	Modem Model
1	460010432615366	Registered to home network	22 (-69dBm)	ME909s-120
2	460029143987644	Registered to home network	7 (-99dBm)	HE910-D

Click the row of SIM card, the details information will show below, please refer to the following screenshot.

^ Status				
Index	IMSI	Registration	Signal Stre...	Modem Mod...
1	460010432615366	Registered to home net...	13 (-87dBm)	ME909s-120
<b>Index</b> 1				
<b>Modem Status</b> Ready				
<b>Current SIM</b> SIM1				
<b>Phone Number</b>				
<b>IMSI</b> 460010432615366				
<b>ICCID</b> 89860114851074491267				
<b>Registration</b> Registered to home network				
<b>Network Provider</b> CHN-UNICOM				
<b>Network Type</b> LTE				
<b>Signal Strength</b> 13 (-87dBm)				
<b>Cell ID</b> 2507,06074702				
<b>Modem Model</b> ME909s-120				
<b>IMEI</b> 867377020134114				
<b>Firmware Version</b> 11.617.01.00.00				
2	460029143987644	Not registered, search s..		HE910-D

Status	
Item	Description
Modem Status	Show the status of the radio module.
Current SIM	Show the SIM card which the router works with currently: SIM1 or SIM2.
Total SIMs	Show the number of SIM cards that is installed in the router.
Phone Number	Show the phone number of the current SIM.
IMSI	Show the IMSI number of the current SIM.
ICCID	Show the ICCID number of the current SIM.
Registration	Show the current network status.

Status	
Item	Description
Network Provider	Show the name of Network Provider.
Network Type	Show the current network service type, e.g. GPRS.
Signal Strength	Show the current signal strength.
Cell ID	Show the current cell ID, which can locate the router.
Modem Model	Show the model of the radio module.
IMEI	Show the IMEI number of the radio module.
Firmware Version	Show the current firmware version of the radio module.

### 3.10 Interface > WiFi

R2000 Dual Router support both WiFi AP and WiFi client. The factory default setting of R2000 Dual is as WiFi AP. This section allow user to configure the parameters of WiFi AP.

#### WiFi AP

##### Configure R2000 Dual as a WiFi AP

Go to **WiFi** tab, select the WiFi mode as AP, click “Submit”;

The screenshot shows the configuration interface for the WiFi AP. At the top, there are five tabs: 'WiFi', 'Access Point', 'Advanced', 'ACL', and 'Status'. The 'Access Point' tab is currently selected. Below the tabs, there is a section titled 'General Settings' with an expandable arrow. Under 'General Settings', there are two configuration fields: 'Mode' is a dropdown menu set to 'AP', and 'Region' is a text input field set to 'SE'. Both fields have a help icon (a question mark in a circle) to their right.

Go to Access Point tab, configure the parameter of WiFi AP. Please remember to click “Save&Apply” and “reboot” after finish the configuration, so that the configuration can be effective.



WiFi	Access Point	Advanced	ACL	Status
<b>^ General Settings</b>				
Enable		<input type="checkbox"/> ON <input checked="" type="checkbox"/> OFF		
Wireless Mode		11bgn Mixed <input type="button" value="v"/>		
Channel		Auto <input type="button" value="v"/> <input type="button" value="?"/>		
SSID		<input type="text" value="router"/>		
Broadcast SSID		<input checked="" type="checkbox"/> ON <input type="checkbox"/> OFF		
Security Mode		WPA <input type="button" value="v"/> <input type="button" value="?"/>		
WPA Version		Auto <input type="button" value="v"/>		
Encryption		Auto <input type="button" value="v"/> <input type="button" value="?"/>		
PSK Password		<input type="text"/>		
Group Key Update Interval		<input type="text" value="3600"/>		

Access Point		
Item	Description	Default
Enable	Click to "ON" side, enable the WiFi access point function.	OFF
Mode	Select from "11bgn Mixed", "11b only", "11g only" and "11n only". 11bgn Mixed: Three protocols mixed in order to backward compatibility 11b only: IEEE 802.11b, 11Mbit/s-- 2.4GHz 11g only: IEEE 802.11g, 54Mbit/s--2.4GHz 11n only: IEEE 802.11n, 300Mbps~600Mbps	11bgn Mixed
Channel	Select the frequency channel, which includes "Auto", "1", "2" ..... "11". Auto: R2000 Dual will scan all frequencies until it finds the best channel. 1~11: R2000 Dual will be fixed to work with this channel. Following are the frequency of 1~ 11 channel. 1 - 2412 MHz 2 - 2417 MHz 3 - 2422 MHz 4 - 2427 MHz 5 - 2432 MHz 6 - 2437 MHz 7 - 2442 MHz 8 - 2447 MHz 9 - 2452 MHz 10 - 2457 MHz 11 - 2462 MHz 12 - 2467 MHz 13 - 2472 MHz	Auto



Access Point		
Item	Description	Default
SSID	SSID (service set identifier) is the network name of the WiFi. The SSID of a client and the SSID of the AP must be identical for the client and AP to be able to communicate with each other. Input from 1 to 31 characters.	router
Broadcast SSID	Click "ON" to enable the SSID broadcasting. So that the client can scan the SSID. If you disable this feature, none of client could scan the SSID. If you want to connect to the router AP, you must need to enter the SSID of router AP at WiFi client side manually.	ON
Security Mode	Select from "Disable", "WPA" and "WEP". Disable: User can access the WiFi without the password when disable security. WPA: Include WPA and WPA2. Personal versions of WPA (Wi-Fi Protected Access), also known as WPA/WPA-PSK (Pre-Shared Key), provide a simple way of encrypting a wireless connection for high confidentiality. WEP: Wired Equivalent Privacy, provide encryption for wireless device's data transmission. It's not recommended to use WEP.	Disable
WPA Version	Select from "Auto", "WPA" and "WPA2". Auto: R2000 Dual will choose the most suitable selection automatically. WPA2 is a stronger security feature than WPA.	Auto
Encryption	Select from "Auto", "TKIP" and "AES". Auto: R2000 Dual will choose the most suitable Encryption automatically. TKIP: Temporal Key Integrity Protocol (TKIP) encryption is used over the wireless link. TKIP encryption can be used with WPA-PSK and WPA with 802.1x authentication. It's not recommended to use TKIP encryption in 802.11n mode. AES: AES encryption is used over the wireless link. AES can be used WPA-PSK and WPA with 802.1x authentication. <b>Note:</b> AES is a stronger encryption algorithm than TKIP.	Auto
PSK Password	PSK password—Pre share key password. When R2000 Dual works as AP mode, enter Master key to generate keys for encryption. A PSK Password is used as a basis for encryption methods (or cipher types) in a WLAN connection. The PSK Password should be complicated and as long as possible. For security reasons, this PSK Password should only be disclosed to users who need it, and it should be changed regularly. Input from 8 to 63 characters.	Null
Group Key Update Interval	Enter the time period of group key renewal.	3600

WiFi	Access Point	Advanced	ACL	Status
<b>^ Advanced Settings</b>				
	<b>Max Associated Stations</b>	<input type="text" value="64"/>		
	<b>Beacon Interval</b>	<input type="text" value="100"/>	<a href="#">?</a>	
	<b>DTIM Period</b>	<input type="text" value="2"/>	<a href="#">?</a>	
	<b>RTS Threshold</b>	<input type="text" value="2347"/>	<a href="#">?</a>	
	<b>Fragmentation Threshold</b>	<input type="text" value="2346"/>	<a href="#">?</a>	
	<b>Transmit Rate</b>	<input type="text" value="Auto"/>	<a href="#">v</a>	
	<b>11N Transmit Rate</b>	<input type="text" value="Auto"/>	<a href="#">v</a>	
	<b>Transmit Power</b>	<input type="text" value="Max"/>	<a href="#">v</a>	
	<b>Channel Width</b>	<input type="text" value="Auto"/>	<a href="#">v</a> <a href="#">?</a>	
	<b>Enable WMM</b>	<input checked="" type="checkbox"/> ON <input type="checkbox"/> OFF		
	<b>Enable Short GI</b>	<input checked="" type="checkbox"/> ON <input type="checkbox"/> OFF	<a href="#">?</a>	
	<b>Enable AP Isolation</b>	<input type="checkbox"/> ON <input checked="" type="checkbox"/> OFF	<a href="#">?</a>	
	<b>Debug Level</b>	<input type="text" value="none"/>	<a href="#">v</a>	

Advanced		
Item	Description	Default
Max Associated Stations	Set the max number of association station to access the router AP.	64
Beacon Interval	Set the frequency of the router AP broadcast Beacon, which was used for wireless network synchronization.	100
DTIM Interval	DTIM (Delivery Traffic Indication Message), router AP will send the multicast traffic according to this interval.	2
RTS Threshold	Set RTS (request to send) threshold to 2347, router AP will never sent the signal before sending out data. Set RTS threshold to 0, router AP will send the signal once it sending out data.	2347
Fragmentation Threshold	Set the fragmentation threshold for WiFi AP data packet. Recommend remain at 2346.	2346
Transmit Rate	Set the transmit rate, you can choose Auto or specify a Transmit Rate.	Auto
11N Transmit Rate	Set the data transmit rate under the IEEE 802.11n WiFi mode. Select "Auto" or a specified transmit rate.	Auto
Transmit Power	Select from "Max", "High", "Medium" and "Low".	Max
Channel Width	Select from "20MHz", "40MHz". 40 MHz channel width provides twice the data rate available over a single 20 MHz channel.	Auto
Enable WMM	Click "ON" to enable WMM.	ON

Advanced		
Item	Description	Default
Enable Short GI	Click "ON" to enable Short GI (Short Guard Interval), short GI is a blank time between two symbols, it can provide a long buffer time to delay signal. Using the Short Guard Interval would provide an 11% increase in data rates, but also may result in higher packet error rates.	ON
Enable AP Isolation	Isolate all connected wireless stations so that wireless stations cannot access each other through WLAN.	OFF
Debug Level	Select from "verbose", "debug", "info", "notice", "warning", "none".	none

WiFi
Access Point
Advanced
ACL
Status

^ General Settings

Enable ACL  ON  OFF

ACL Mode  v ?

ACL

^ Access Control List

Index

Description

MAC Address

ACL		
Item	Description	Default
Enable ACL	Click to enable ACL (Access Control List).	Disable
ACL Mode	Select from "Accept" and "Deny". Accept: Only the packets fitting the entities of the "Access Control List" can be allowed. Deny: All the packets fitting the entities of the "Access Control List" will be denied. <b>Note:</b> R2000 Dual can only allow or deny devices which are included in "Access Control List" at one time.	Accept
Access Control List	Click " <span style="color: blue; font-weight: bold;">+</span> " to add MAC address.	Null

This section allow user to check the AP status and those WiFi client had connected to R2000 Dual AP.

WiFi   Access Point   Advanced   ACL   Status

^ AP Status

Status   COMPLETED

Channel   6

Channel Width   20 MHz

MAC Address   34:FA:40:08:6A:B5

^ Associated Stations

Index	MAC Address	IP Address	Name	Connected Time	Signal
1	14:B9:68:71:E7:75			8	-71 dBm

## WiFi Client

### Configure R2000 Dual as a WiFi client

R2000 Dual Router support both WiFi AP and WiFi client. The factory default setting of R2000 Dual is as WiFi AP. This section allow user to configure the R2000 Dual Router as a WiFi client and set the related parameters.

Go to **WiFi** tab, select the WiFi mode as Client, click “Submit”;

WiFi

^ General Settings

Mode   Client   ?

Region   SE   ?

Go to the **3.6 Link Manager > WLAN** tab Configure the WiFi AP parameters, and the way of configuration refer to the **3.6 Interface > Link Manager** Section. Please remember to click “Save&Apply” and “reboot” after finish the configuration, so that the configuration can be effective.

After configure R2000 Dual as WiFi Client successfully, a WLAN page will be generated under the “**Interface**” tab. Go to **Interface > WLAN** check the WLAN connection status. It includes WLAN status, Link status and WPA status.

## Status

## ^ WLAN Status

<b>Status</b>	Connected
<b>Uptime</b>	0 days, 00:00:05
<b>IP Address</b>	192.168.43.246/255.255.255.0
<b>Gateway</b>	192.168.43.1
<b>DNS</b>	192.168.43.1
<b>MAC Address</b>	34:fa:40:08:6a:b5

## ^ Link Status

<b>Signal</b>	-64 dBm
<b>Noise</b>	-95 dBm
<b>Width</b>	20 MHz
<b>TX Bitrate</b>	52.0 MBit/s MCS 5
<b>TX</b>	1199 bytes (7 packets)
<b>RX</b>	6333 bytes (62 packets)

## ^ WPA Status

<b>WPA State</b>	COMPLETED
<b>Frequency</b>	2437
<b>BSSID</b>	16:b9:68:71:e7:75
<b>SSID</b>	faye22222
<b>Mode</b>	station
<b>Key Management</b>	WPA2-PSK
<b>Pairwise Cipher</b>	CCMP
<b>Group Cipher</b>	CCMP

^ Scan Results				
Index	SSID	MAC Address	Frequency	Signal
1	faye22222	16:B9:68:71:E7:75	2437	-65 dBm
2	3gRouter_AP	00:25:5E:B5:12:35	2437	-65 dBm
3	cfg_ap_ssid	54:36:9B:07:74:71	2422	-70 dBm
4	ABCD	14:CF:92:0A:1B:19	2457	-86 dBm
5	wlan	00:04:ED:BF:0A:3B	2412	-83 dBm

User can scan the surrounding SSIDs in this section. Please click  , and then click “Scan” to scan the surrounding SSIDs.

^ Scan Results				
Index	SSID	MAC Address	Frequency	Signal
 <a href="#">Scan</a>				

### 3.11 Network > Route

This section allows user to set the static route. (The maximum number of the static route is twenty.)

Static Route		Status				
^ Static Route Table						
Index	Description	Destination	Netmask	Gateway	Interface	+

Click  to add static routes, the maximum number of static routes is 20.

**Static Route**

^ Static Route

Index:

Description:

Destination:

Netmask:

Gateway:

Interface:

Static Route		
Item	Description	Default
Index	Show the index of the static route.	1
Destination	Define the destination IP address.	Null



Static Route		
Item	Description	Default
Netmask	Define the Netmask of the destination.	Null
Gateway	Define the gateway of the destination.	Null
Interface	Select from "LAN", "WAN", "TUN"	LAN

This section allow user to check all the route of R2000 Dual.

Static Route		Status			
^ Route Table					
Index	Destination	Netmask	Gateway	Interface	Metric
1	172.16.0.0	255.255.0.0	0.0.0.0	eth-br	0

### 3.12 Network > Firewall

This section allows users to set the Firewall and the related parameters, which includes "Filter", "Port Mapping" and "DMZ".

#### Filtering

Filtering	Port Mapping	DMZ					
^ General Settings							
Enable Filtering		<input checked="" type="checkbox"/> ON <input type="checkbox"/> OFF					
Default Filtering Policy		Accept <input type="button" value="v"/> <input type="button" value="?"/>					
^ Access Control							
Enable Remote SSH Access	<input type="checkbox"/> ON <input checked="" type="checkbox"/> OFF						
Enable Local SSH Access	<input checked="" type="checkbox"/> ON <input type="checkbox"/> OFF						
Enable Remote Telnet Access	<input type="checkbox"/> ON <input checked="" type="checkbox"/> OFF						
Enable Local Telnet Access	<input checked="" type="checkbox"/> ON <input type="checkbox"/> OFF						
Enable Remote HTTP Access	<input type="checkbox"/> ON <input checked="" type="checkbox"/> OFF						
Enable Local HTTP Access	<input checked="" type="checkbox"/> ON <input type="checkbox"/> OFF						
Enable Remote HTTPS Access	<input checked="" type="checkbox"/> ON <input type="checkbox"/> OFF						
Enable Remote Ping Respond	<input checked="" type="checkbox"/> ON <input type="checkbox"/> OFF <input type="button" value="?"/>						
Enable DOS Defending	<input checked="" type="checkbox"/> ON <input type="checkbox"/> OFF						
^ Filtering Rules							
Index	Source Address	Source Port	Source MAC	Target Address	Target Port	Protocol	<input type="button" value="+"/>

Click  to add filtering rules. (The maximum number of the filtering rule is twenty).

**^ Filtering Rules**

<b>Index</b>	<input style="width: 100%;" type="text" value="2"/>
<b>Description</b>	<input style="width: 100%;" type="text"/>
<b>Source Address</b>	<input style="width: 100%;" type="text"/> 
<b>Source MAC</b>	<input style="width: 100%;" type="text"/> 
<b>Target Address</b>	<input style="width: 100%;" type="text"/> 
<b>Protocol</b>	<input style="width: 100%;" type="text" value="All"/> 
<b>Action</b>	<input style="width: 100%;" type="text" value="Drop"/> 

Filtering		
Item	Description	Default
Enable Filtering	Enable filtering rules.	ON
Default Filtering Policy	Select from “Accept” and “Drop”. Accept: Router will accept all the connecting requests except the hosts which fit the filter list. Drop: Router will only reject the connecting requests from the hosts which fit the filter list.	accept
Enable Remote SSH Access	Enable to allow users to access the router remotely on the internet side via SSH.	OFF
Enable Local SSH Access	Enable to allow users to access the router on the local Ethernet via SSH.	ON
Enable Remote Telnet Access	Enable to allow users to access the router remotely on the internet side via Telnet.	OFF
Enable Local Telnet Access	Enable to allow users to access the router on the local Ethernet via Telnet.	ON
Enable Remote Http Access	Enable to allow users to access the router remotely on the internet side via Http.	OFF
Enable Local Http Access	Enable to allow users to access the router on the local Ethernet via Http.	ON
Enable Remote Https Access	Enable to allow users to access the router remotely on the internet side via Https.	ON
Enable Remote Ping Respond	Enable to make router reply the Ping requests from the internet side.	ON
Enable DOS Defending	Enable to defend dos attack. Dos attack is an attempt to make a machine or network resource unavailable to its intended users.	ON
Index	Show the index of the filtering rule or the MAC binding rule.	1
Source Address	Defines if access is allowed from one or a range of IP addresses which are defined by Source IP Address, or every IP addresses.	Null
Source MAC	Enter the MAC address of the defined source IP address.	Null
Target Address	Defines if access is allowed to one or a range of IP addresses which are defined by Target IP Address, or every IP addresses.	Null



Filtering		
Item	Description	Default
Protocol	Select from "All", "TCP", "UDP", "ICMP", "TCP-UDP". If you don't know what kinds of protocol of your application, we recommend you select "ALL".	All
Action	Select from "Accept", "Drop".	Drop

## Port Mapping

Filtering	Port Mapping	DMZ				
<b>^ Port Mapping Rules</b>						
Index	Description	Internet Port	Local IP	Local Port	Protocol	+

Click **+** to add port mapping rules. (The maximum number of the port mapping rule is forty.)

^ Port Mapping Rules	
Index	<input type="text" value="1"/>
Description	<input type="text"/>
Internet Port	<input type="text"/> ?
Local IP	<input type="text"/>
Local Port	<input type="text"/> ?
Protocol	TCP-UDP <input type="button" value="v"/>

Port Mapping		
Item	Description	Default
Index	Show the index of the port mapping rule.	1
Internet Port	The port of the internet side which you want to forward to LAN side.	Null
Local IP	The device's IP on the LAN side which you want to forward the data to.	Null
Local Port	The device's port on the LAN side which you want to forward the data to.	Null
Protocol	Select from "TCP", "UDP" and "TCP-UDP".	TCP-UDP

## DMZ

DMZ		
Item	Description	Default
Enable DMZ	Select to enable the DMZ function. DMZ host is a host on the internal network that has all ports exposed, except those ports otherwise forwarded.	OFF
Host IP Address	Enter the IP address of the DMZ host which on the internal network.	Null
Source IP Address	Set the address which can talk to the DMZ host. Null means for any addresses.	Null

### 3.13 Network > IP Passthrough

Click the switch to enable or disable IP Passthrough function.

When configure R2000 Dual’s WAN mode as DHCP server and enable the IP Passthrough function, R2000 Dual could pass the IP address (and DNS server) which was assigned by an ISP on a PPP connection, to the behind device running a DHCP client.

### 3.14 VPN > IPsec

This section allows users to set the IPsec and the related parameters.

#### General

General		
Item	Description	Default
Enable NAT Traversal	Tick to enable NAT Traversal for IPsec. This item must be enabled when router under NAT environment.	ON
Keepalive	The interval that router sends packets to NAT box so that to avoid it remove the NAT mapping.	60
Debug Enable	Enable this function, and it will output IPsec information to the debug port.	OFF

#### Tunnel

Click to add tunnel settings. (The maximum number of the tunnel is three.)

Tunnel Settings		
Item	Description	Default
Index	Show the index of the tunnel.	1
Enable	Enable IPsec Tunnel.	ON
Description	Enter some simple words about the IPsec Tunnel.	Null
Gateway	Enter the address of remote side IPsec VPN server.	Null
Mode	Select from "Tunnel" and "Transport". Tunnel: Commonly used between gateways, or at an end-station to a gateway, the gateway acting as a proxy for the hosts behind it. Transport: Used between end-stations or between an end-station and a gateway, if the gateway is being treated as a host-for example, an encrypted Telnet session from a workstation to a router, in which the router is the actual destination.	Tunnel
Protocol	Select the security protocols from "ESP" and "AH". ESP: Uses the ESP protocol. AH: Uses the AH protocol.	ESP
Local Subnet	Enter IPsec Local Protected subnet's address with mask, e.g. 192.168.1.0/24	Null
Remote Subnet	Enter IPsec Remote Protected subnet's address with mask, e.g. 10.8.0.0/24	Null

When choose "Authentication Type" to "PSK".

**^ IKE Settings**

<b>Negotiation Mode</b>	<input type="text" value="Main"/> <span style="float: right;">v</span>
<b>Authentication Algorithm</b>	<input type="text" value="MD5"/> <span style="float: right;">v</span>
<b>Encrypt Algorithm</b>	<input type="text" value="3DES"/> <span style="float: right;">v</span>
<b>IKE DH Group</b>	<input type="text" value="MODP(1024)"/> <span style="float: right;">v</span>
<b>Authentication Type</b>	<input type="text" value="PSK"/> <span style="float: right;">v</span>
<b>PSK Secret</b>	<input type="text"/>
<b>Local ID Type</b>	<input type="text" value="Default"/> <span style="float: right;">v</span>
<b>Remote ID Type</b>	<input type="text" value="Default"/> <span style="float: right;">v</span>
<b>IKE Lifetime</b>	<input type="text" value="86400"/> <span style="float: right;">?</span>

When choose "Authentication Type" to "CA".

^ IKE Settings	
Negotiation Mode	Main <input type="button" value="v"/>
Authentication Algorithm	MD5 <input type="button" value="v"/>
Encrypt Algorithm	3DES <input type="button" value="v"/>
IKE DH Group	MODP(1024) <input type="button" value="v"/>
Authentication Type	CA <input type="button" value="v"/>
Private Key Password	<input type="text"/>
IKE Lifetime	86400 <input type="button" value="?"/>

When choose "Authentication Type" to "xAuth PSK".

^ IKE Settings	
Negotiation Mode	Main <input type="button" value="v"/>
Authentication Algorithm	MD5 <input type="button" value="v"/>
Encrypt Algorithm	3DES <input type="button" value="v"/>
IKE DH Group	MODP(1024) <input type="button" value="v"/>
Authentication Type	xAuth PSK <input type="button" value="v"/>
PSK Secret	<input type="text"/>
Local ID Type	Default <input type="button" value="v"/>
Remote ID Type	Default <input type="button" value="v"/>
Username	<input type="text"/> <input type="button" value="?"/>
Password	<input type="text"/> <input type="button" value="?"/>
IKE Lifetime	86400 <input type="button" value="?"/>

When choose "Authentication Type" to "xAuth CA".

^ IKE Settings	
Negotiation Mode	Main <input type="button" value="v"/>
Authentication Algorithm	MD5 <input type="button" value="v"/>
Encrypt Algorithm	3DES <input type="button" value="v"/>
IKE DH Group	MODP(1024) <input type="button" value="v"/>
Authentication Type	xAuth CA <input type="button" value="v"/>
Private Key Password	<input type="text"/>
Username	<input type="text"/> <input type="button" value="?"/>
Password	<input type="text"/> <input type="button" value="?"/>
IKE Lifetime	86400 <input type="button" value="?"/>

**IKE Settings**

Item	Description	Default
Negotiation Mode	Select from "Main" and "Aggressive" for the IKE negotiation mode in phase 1. If the IP address of one end of an IPsec tunnel is obtained dynamically, the IKE negotiation mode must be aggressive. In this case, SAs can be established as long as the username and password are correct.	Main
Authentication Algorithm	Select from "MD5" and "SHA1" to be used in IKE negotiation. MD5: Uses HMAC-SHA1. SHA1: Uses HMAC-MD5.	MD5
Encrypt Algorithm	Select from "3DES", "AES128" and "AES256" to be used in IKE negotiation. 3DES: Uses the 3DES algorithm in CBC mode and 168-bit key. AES128: Uses the AES algorithm in CBC mode and 128-bit key. AES256: Uses the AES algorithm in CBC mode and 256-bit key.	3DES
IKE DH Group	Select from "MODP (1024)" and "MODP (1536)" to be used in key negotiation phase 1. MODP (1024): Uses the 1024-bit Diffie-Hellman group. MODP (1536): Uses the 1536-bit Diffie-Hellman group.	MODP (1024)
Authentication Type	Select from "PSK", "CA", "xAuth PSK" and "xAuth CA" to be used in IKE negotiation. PSK: Pre-shared Key. CA: Certification Authority. xAuth: Extended Authentication to AAA server.	PSK
PSK Secret	Enter the pre-shared key.	Null
Local ID Type	Select from "IP Address", "FQDN" and "User FQDN" for IKE negotiation. "Default" stands for "IP Address". IP Address: Uses an IP address as the ID in IKE negotiation. FQDN: Uses an FQDN type as the ID in IKE negotiation. If this option is selected, type a name without any at sign (@) for the local security gateway, e.g., test.robustel.com. User FQDN: Uses a user FQDN type as the ID in IKE negotiation. If this option is selected, type a name string with a sign "@" for the local security gateway, e.g., test@robustel.com.	Default
Remote ID Type	Select from "IP Address", "FQDN" and "User FQDN" for IKE negotiation. IP Address: Uses an IP address as the ID in IKE negotiation. FQDN: Uses an FQDN type as the ID in IKE negotiation. If this option is selected, type a name without any at sign (@) for the local security gateway, e.g., test.robustel.com. User FQDN: Uses a user FQDN type as the ID in IKE negotiation. If this option is selected, type a name string with a sign "@" for the local security gateway, e.g., test@robustel.com.	Default
IKE Lifetime	Set the lifetime in IKE negotiation. Before an SA expires, IKE negotiates a new SA. As soon as the new SA is set up, it takes effect immediately and the old one will be cleared automatically when it expires.	86400

IKE Settings		
Item	Description	Default
Private Key Password	Enter the private key.	Null
Username	User name used for xAuth.	Null
Password	Password used for xAuth.	Null

When choose the “Tunnel Setting > General Setting > Protocol” to “ESP”.

^ SA Settings

Encrypt Algorithm	<input type="text" value="3DES"/>	▼
Authentication Algorithm	<input type="text" value="MD5"/>	▼
PFS Group	<input type="text" value="MODP(1024)"/>	▼
SA Lifetime	<input type="text" value="28800"/>	?
DPD Interval	<input type="text" value="60"/>	?
DPD Failures	<input type="text" value="180"/>	

When choose the “Tunnel Setting > Protocol” to “AH”.

^ SA Settings

Authentication Algorithm	<input type="text" value="MD5"/>	▼
PFS Group	<input type="text" value="MODP(1024)"/>	▼
SA Lifetime	<input type="text" value="28800"/>	?
DPD Interval	<input type="text" value="60"/>	?
DPD Failures	<input type="text" value="180"/>	

^ Advanced Settings

Enable Compression	<input type="checkbox"/> OFF
--------------------	------------------------------

SA Settings		
Item	Description	Default
Encrypt Algorithm	Select from “3DES”, “AES128” and “AES256” when you select “ESP” in “Protocol”; <b>Note:</b> Higher security means more complex implementation and lower speed. DES is enough to meet general requirements. Use 3DES when high confidentiality and security are required.	3DES
Authentication Algorithm	Select from “MD5” and “SHA1” to be used in SA negotiation.	MD5
PFS Group	Select from “PFS (N/A)”, “MODP (1024)” and “MODP (1536)”. PFS (N/A): Disable PFS Group MODP (1024): Uses the 1024-bit Diffie-Hellman group. MODP (1536): Uses the 1536-bit Diffie-Hellman group.	MODP (1024)

SA Settings		
Item	Description	Default
SA Lifetime	Set the IPsec SA lifetime. <b>Note:</b> When negotiating to set up IPsec SAs, IKE uses the smaller one between the lifetime set locally and the lifetime proposed by the peer.	28800
DPD Interval	Set the interval after which DPD is triggered if no IPsec protected packets is received from the peer. DPD: Dead peer detection. DPD irregularly detects dead IKE peers. When the local end sends an IPsec packet, DPD checks the time the last IPsec packet was received from the peer. If the time exceeds the DPD interval, it sends a DPD hello to the peer. If the local end receives no DPD acknowledgment within the DPD packet retransmission interval, it retransmits the DPD hello. If the local end still receives no DPD acknowledgment after having made the maximum number of retransmission attempts, it considers the peer already dead, and clears the IKE SA and the IPsec SAs based on the IKE SA.	60
DPD Failures	Set the timeout of DPD packets.	180
Advanced Settings		
Enable Compression	Tick to enable compressing the inner headers of IP packets.	OFF

## Status

This section allow user to check the status of the IPsec tunnel.

General	Tunnel	Status	x509
<b>^ Tunnel Status</b>			
Index	Description	Status	Uptime

## x509

User can upload the X509 certificate for the IPsec tunnel in this section.

General	Tunnel	Status	x509
<b>^ X509 Settings</b>			
Tunnel Name		<input type="text" value="Tunnel 1"/>	
Certificate Files		<input type="button" value="Choose File"/> No file chosen <input type="button" value="Upload"/>	
<b>^ Certificate Files</b>			
Index	File Name	File Size	Last Modification

x509		
Item	Description	Default
Tunnel Name	Select the name of the tunnel.	Tunnel 1





x509		
Item	Description	Default
Certificate Files	Choose the correct file to import the certificate into the router. The correct file format as followings: @ca.crt @remote.crt @local.crt @private.key @crl.pem	Null
Index	Show the index of the certificate file.	Null
Filename	Show the name of the certificate file.	Null
File Size	Show the size of the certificate file.	Null
Last Modification	Show the timestamp of that the last time to modify the certificate file.	Null

### 3.15 VPN > OpenVPN

This section allows users to set the OpenVPN and the related parameters.

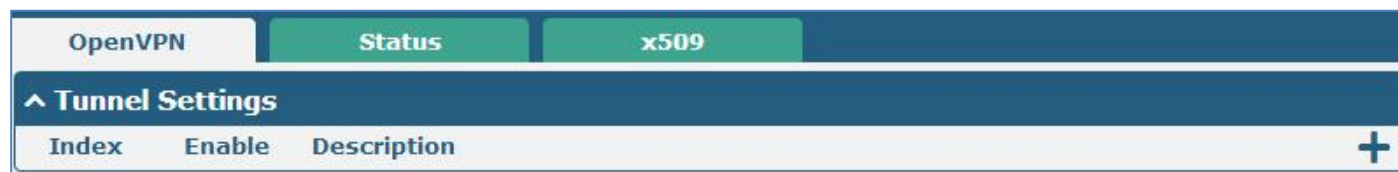
#### OpenVPN



Click  to add tunnel settings. (The maximum number of the tunnel is three.)

When choose "Authentication Type" to "None".

**^ Tunnel Settings**

Index	<input type="text" value="1"/>
Enable	<input checked="" type="checkbox"/> ON <input type="checkbox"/> OFF
Description	<input type="text"/>
Mode	<input type="text" value="Client"/> v
Protocol	<input type="text" value="UDP"/> v
Server Address	<input type="text"/>
Server Port	<input type="text" value="1194"/>
Interface Type	<input type="text" value="TUN"/> v
Authentication Type	<input type="text" value="None"/> v ?
Keepalive Interval	<input type="text" value="20"/> ?
Keepalive Timeout	<input type="text" value="120"/> ?
Enable Compression	<input checked="" type="checkbox"/> ON <input type="checkbox"/> OFF
Enable NAT	<input type="checkbox"/> ON <input checked="" type="checkbox"/> OFF

Verbose Level  v ?

When choose "Authentication Type" to "Password".

**^ Tunnel Settings**

Index	<input type="text" value="1"/>
Enable	<input checked="" type="checkbox"/> ON <input type="checkbox"/> OFF
Description	<input type="text"/>
Mode	<input type="text" value="Client"/> v
Protocol	<input type="text" value="UDP"/> v
Server Address	<input type="text"/>
Server Port	<input type="text" value="1194"/>
Interface Type	<input type="text" value="TUN"/> v
Authentication Type	<input type="text" value="Password"/> v ?
Username	<input type="text"/>
Password	<input type="text"/>
Encrypt Algorithm	<input type="text" value="BF"/> v
Keepalive Interval	<input type="text" value="20"/> ?

Keepalive Timeout	<input type="text" value="120"/> ?
Enable Compression	<input checked="" type="checkbox"/> ON <input type="checkbox"/> OFF
Enable NAT	<input type="checkbox"/> ON <input checked="" type="checkbox"/> OFF
Verbose Level	<input type="text" value="0"/> v ?

When choose "Authentication Type" to "X509CA".

**^ Tunnel Settings**

Index	<input type="text" value="1"/>
Enable	<input checked="" type="checkbox"/> ON <input type="checkbox"/> OFF
Description	<input type="text"/>
Mode	<input type="text" value="Client"/> v
Protocol	<input type="text" value="UDP"/> v
Server Address	<input type="text"/>
Server Port	<input type="text" value="1194"/>
Interface Type	<input type="text" value="TUN"/> v
Authentication Type	<input type="text" value="X509CA"/> v ?
Encrypt Algorithm	<input type="text" value="BF"/> v
Keepalive Interval	<input type="text" value="20"/> ?

Keepalive Timeout	<input type="text" value="120"/> ?
Enable Compression	<input checked="" type="checkbox"/> ON <input type="checkbox"/> OFF
Enable NAT	<input type="checkbox"/> ON <input checked="" type="checkbox"/> OFF
Verbose Level	<input type="text" value="0"/> v ?

When choose “Authentication Type” to “X509CA Password”.

^ Tunnel Settings

Index	<input type="text" value="1"/>
Enable	<input checked="" type="checkbox"/> ON <input type="checkbox"/> OFF
Description	<input type="text"/>
Mode	<input type="text" value="Client"/> ▼
Protocol	<input type="text" value="UDP"/> ▼
Server Address	<input type="text"/>
Server Port	<input type="text" value="1194"/>
Interface Type	<input type="text" value="TUN"/> ▼
Authentication Type	<input type="text" value="X509CA Password"/> ▼ <span style="float: right;">?</span>
Username	<input type="text"/>
Password	<input type="text"/>
Encrypt Algorithm	<input type="text" value="BF"/> ▼
Keepalive Interval	<input type="text" value="20"/> <span style="float: right;">?</span>
Keepalive Timeout	<input type="text" value="120"/> <span style="float: right;">?</span>
Enable Compression	<input checked="" type="checkbox"/> ON <input type="checkbox"/> OFF
Enable NAT	<input type="checkbox"/> ON <input checked="" type="checkbox"/> OFF
Verbose Level	<input type="text" value="0"/> ▼ <span style="float: right;">?</span>

Tunnel Settings		
Item	Description	Default
Index	Show the index of the tunnel.	1
Enable	Enable OpenVPN tunnel.	ON
Description	Enter some simple words about the OpenVPN Tunnel.	Null
Mode	Select from “P2P”, “Client”.	Client
Protocol	Select from “UDP”, “TCP-Client”.	UDP
Server Address	Enter the OpenVPN server address.	Null
Server Port	Enter the OpenVPN server port	1194
Interface Type	Select from “TUN”, “TAP” which are two different kinds of device interface for OpenVPN. The difference between TUN and TAP device is this: a TUN device is a virtual IP point-to-point device and a TAP device is a virtual Ethernet device.	TUN
Authentication Type	Select from “None”, “Preshared”, “Password”, “X509CA” and “X509CA Password”. “None” and “Preshared” type just work with p2p mode.	None
Local IP	When the “Mode” is “P2P”. Define the local IP address of OpenVPN tunnel.	Null

Tunnel Settings		
Item	Description	Default
Remote IP	When the "Mode" is "P2P". Define the remote IP address of OpenVPN tunnel.	Null
Username	User name used for Authentication Type "Password" or "X509CA Password".	Null
Password	Password used for Authentication Type "Password" or "X509CA Password".	Null
Encrypt Algorithm	Select from "BF", "DES", "DES-EDE3", "AES128", "AES192" and "AES256". BF: Uses the BF algorithm in CBC mode and 128-bit key. DES: Uses the DES algorithm in CBC mode and 64-bit key. DES-EDE3: Uses the 3DES algorithm in CBC mode and 192-bit key. AES128: Uses the AES algorithm in CBC mode and 128-bit key. AES192: Uses the AES algorithm in CBC mode and 192-bit key. AES256: Uses the AES algorithm in CBC mode and 256-bit key.	BF
Keepalive Interval	Set keepalive (ping) interval to check if the tunnel is active.	20
Keepalive Timeout	Trigger OpenVPN restart after n seconds pass without reception of a ping or other packet from remote.	120
Private Key Password	Password of Private Key for Authentication Type "X509CA"	Null
Enable Compression	Enable to compress the data stream.	ON
Enable NAT	Tick to enable NAT for OpenVPN. The source IP address of host behind R2000 Dual will be disguised before accessing the remote OpenVPN client.	OFF
Verbose Level	Select the level of the output log. Values range from 0 to 11. 0 -- No output except fatal errors. 1 to 4 -- Normal usage range. 5 -- Output R and W characters to the console for each packet read and write. 6 to 11 -- Debug info range	0

**^ Advanced Settings**

Enable HMAC Firewall  OFF

Enable PKCS#12  OFF

Enable nsCertType  OFF

Expert Options  ?

Advanced Settings		
Item	Description	Default
Enable HMAC Firewall	Add an additional layer of HMAC authentication on top of the TLS control channel to protect against DoS attacks.	OFF

Enable PKCS#12	Enable the PKCS#12 certificate. It is an exchange of digital certificate encryption standard, used to describe personal identity information.	OFF
Enable nsCertType	Require that peer certificate was signed with an explicit nsCertType designation of "server".	OFF
Expert Options	You can enter some other options of OpenVPN in this field. Each expression can be separated by a ','.	Null

## Status

OpenVPN
Status
x509

^ Tunnel Status

Index	Description	Status	Uptime
-------	-------------	--------	--------

## x509

OpenVPN
Status
x509

^ X509 Settings ?

Tunnel Name Tunnel 1 v

Certificate Files Choose File No file chosen ↑

^ Certificate Files

Index	File Name	File Size	Last Modification
-------	-----------	-----------	-------------------

x509		
Item	Description	Default
Tunnel Name	Select the name of the Tunnel1 to Tunnel3. Because the maximum number of the tunnel is three.	Tunnel 1
Certificate Files	Choose the correct file to import the certificate into the router. The correct file format as followings: @ca.crt @remote.crt @local.crt @private.key @crl.pem	Null
Index	Show the index of the certificate file.	Null
Filename	Show the name of the certificate file.	Null
File Size	Show the size of the certificate file.	Null
Last Modification	Show the timestamp of that the last time to modify the certificate file.	Null

## 3.16 VPN > GRE

This section allows users to set the OpenVPN and the related parameters.

Click to add tunnel settings. (The maximum number of the tunnel is three.)

GRE		
Item	Description	Default
Index	Show the index of the tunnel.	1
Enable	Enable GRE tunnel. GRE (Generic Routing Encapsulation) is a protocol that encapsulates packets in order to route other protocols over IP networks.	ON
Description	Enter some simple words about the GRE Tunnel.	Null
Remote IP Address	Set remote IP Address of the virtual GRE tunnel.	Null
Local Virtual IP	Set local IP Address of the virtual GRE tunnel.	Null
Remote virtual IP	Set remote IP Address of the virtual GRE tunnel.	Null
Enable Default Route	All the traffics of R2000 Dual Router will go through the GRE VPN.	OFF
Enable NAT	Tick to enable NAT for GRE. The source IP address of host Behind R2000 Dual will be disguised before accessing the remote GRE server.	Disable
Secrets	Set Tunnel Key of GRE.	Null

This section allow user to check the status of GRE tunnel.



GRE	Status				
^ GRE tunnel status					
Index	Description	Status	Local IP Address	Remote IP Address	Uptime

### 3.17 Services > Syslog

This section allows users to set the syslog parameters.

Syslog
^ Syslog Settings
<p>Enable <input type="checkbox"/> ON <input checked="" type="checkbox"/> OFF</p> <p>Syslog Level <input type="text" value="Notice"/> v</p> <p>Save Position <input type="text" value="RAM"/> v ?</p> <p>Log to Remote <input type="checkbox"/> ON <input checked="" type="checkbox"/> OFF ?</p>
^ Application Debug Control
<p>Enable Modem Debug <input checked="" type="checkbox"/> ON <input type="checkbox"/> OFF</p> <p>Enable Link Manager Debug <input checked="" type="checkbox"/> ON <input type="checkbox"/> OFF</p> <p>Enable App Debug <input checked="" type="checkbox"/> ON <input type="checkbox"/> OFF ?</p>

Syslog		
Syslog Settings		
Item	Description	Default
Enable	Click to enable Syslog setting.	OFF
Syslog Level	Select form "Debug", "Info", "Notice", "Warning", "Error" which from low to high. The lower level will output more syslog in detail.	Notice
Save Position	Select the save position from "RAM", "NVM" and "Console". Choose "RAM", the data will be cleared after reboot. But it's not recommended that saving syslog to NVM (Non-Volatile Memory) for a long time.	RAM
Log to Remote	Enable to allow router sending syslog to the remote syslog server. You need to enter the IP and Port of the syslog server.	OFF
Application Debug Control		
Enable Modem Debug	Click to enable router to debug Modem.	ON
Enable Link Manager Debug	Click to enable router to debug Link Manager.	ON
Enable APP Debug	Click to enable router's debug control for all other applications.	ON

### 3.18 Services > Event

This section allows users to set the Event parameters.

Event
Notification
Query

^ General Settings

Signal Quality Threshold  ?

Event @ Event		
Item	Description	Default
Signal Quality Threshold	Router will generate log event when signal quality less than the threshold, 0 means disable.	0

Event
Notification
Query

^ Event Notification Group Settings

<span>Index</span>	<span>Description</span>	<span>Send SMS</span>	<span>Save to NVM</span>		<span style="font-size: 24px; color: #1a3d4d;">+</span>
--------------------	--------------------------	-----------------------	--------------------------	--	---

Click + button to add an Event parameters.

Notification

^ General Settings

Index

Description

Send SMS ON OFF

Send Email ON OFF

Email Addresses  ?

Save to NVM ON OFF ?

^ Event Selector

System Startup	<span style="background-color: #008080; color: white; padding: 2px 5px; border-radius: 3px;">ON</span> <span style="background-color: #1a3d4d; color: white; padding: 2px 5px; border-radius: 3px;">OFF</span>
System Reboot	<span style="background-color: #008080; color: white; padding: 2px 5px; border-radius: 3px;">ON</span> <span style="background-color: #1a3d4d; color: white; padding: 2px 5px; border-radius: 3px;">OFF</span>
System Time Update	<span style="background-color: #008080; color: white; padding: 2px 5px; border-radius: 3px;">ON</span> <span style="background-color: #1a3d4d; color: white; padding: 2px 5px; border-radius: 3px;">OFF</span>
Configuration Change	<span style="background-color: #008080; color: white; padding: 2px 5px; border-radius: 3px;">ON</span> <span style="background-color: #1a3d4d; color: white; padding: 2px 5px; border-radius: 3px;">OFF</span>
Cellular Network Type Change	<span style="background-color: #008080; color: white; padding: 2px 5px; border-radius: 3px;">ON</span> <span style="background-color: #1a3d4d; color: white; padding: 2px 5px; border-radius: 3px;">OFF</span>
Cellular Data Stats Clear	<span style="background-color: #008080; color: white; padding: 2px 5px; border-radius: 3px;">ON</span> <span style="background-color: #1a3d4d; color: white; padding: 2px 5px; border-radius: 3px;">OFF</span>
Poor Signal Quality	<span style="background-color: #008080; color: white; padding: 2px 5px; border-radius: 3px;">ON</span> <span style="background-color: #1a3d4d; color: white; padding: 2px 5px; border-radius: 3px;">OFF</span>
Link Switching	<span style="background-color: #008080; color: white; padding: 2px 5px; border-radius: 3px;">ON</span> <span style="background-color: #1a3d4d; color: white; padding: 2px 5px; border-radius: 3px;">OFF</span>

Notification@ Event		
Item	Description	Default
Index	The index of event notification group.	1
Description	Enter some simple words to describe the Notify Group.	Null
Sent SMS	Click to enable router to send event notification SMS. Set the phone number that is used for receiving event notification, and use ‘;’ to separate each number.	OFF
Sent Email	Click to enable router to send event notification with email. Go to <b>3.21 Services &gt; Email</b> to configure email settings.	OFF
Email Address	Enter the receiver’s email address. Email addresses to receive event notification, use blank to separate each address.	Null
Save to NVM	Click to enable router to save event to nonvolatile memory.	OFF
Event Selector	Click to enable Event feature. There are numbers of R2000 Dual’s main running event code you can select, such as “System Startup”, “System Reboot”, “System Time Update”, “Configuration Change”, “Cellular Network Type Change”, “Cellular Data Stats Clear”, “Poor Signal Quality”, “Link Switching”, “WWAN Up”, “WWAN Down”, “IPsec Connection Up”, “IPsec Connection Down”, “OpenVPN Connection Up”, “OpenVPN Connection Down”, “LAN Port Link Up”, “LAN Port Link Down”, “Received SMS” and “SMS Command Execute”.	OFF

Event
Notification
Query

^ Event Detail

Save Position  v

Filter Message

```
Feb 11 08:24:54, system startup
Feb 11 08:24:58, LAN port link up, port 1
Feb 11 08:25:12, WWAN (cellular) up, using SIM1
Feb 11 08:25:25, system time update
Feb 11 09:25:26, WWAN (cellular) down, using SIM1
Feb 11 09:25:39, WWAN (cellular) up, using SIM1
```

Clear
Refresh

Query @ Event		
Item	Description	Default
Save Position	Select the events' save position from "RAM", "NVM". RAM: Random-access memory. NVM: Non-Volatile Memory.	RAM
Filter Message	Event will be filtered according to the Filter Message that the user set. Click the Refresh button, the filtered event will be displayed in the follow box. Use "&" to separate more than one filter message, such as message1&message2.	Null

### 3.19 Services > NTP

This section allows users to set the NTP parameters.

NTP
Status

^ Timezone Settings

Time Zone

Expert Setting

?

^ NTP Client Settings

Enable

ON  OFF

Primary NTP Server

Secondary NTP Server

NTP Update Interval

?

^ NTP Server Settings

Enable

ON  OFF

Timezone Settings @ NTP		
Item	Description	Default
Time Zone	Select your local time zone.	UTC +08:00
Expert Setting	Specify the time zone with Daylight Saving Time in TZ environment variable format. The Time Zone option will be ignored in this case.	Null
NTP Client Setting @ NTP		
Enable	Click to enable the router to synchronize time from NTP server. <b>Note:</b> R2000 Dual doesn't have the RTC, so NTP client function must always be ON.	ON
Primary NTP Server	Enter primary NTP Server's IP address or domain name.	pool.nt p.org

Secondary NTP Server	Enter secondary NTP Server's IP address or domain name.	Null
NTP Update interval	Enter the interval (minutes) which NTP client synchronize the time from NTP server. Minutes wait for next update, 0 means update only once.	0
<b>NTP Client Setting @ NTP</b>		
Enable	Click to enable the NTP server function of router.	OFF

The status part of NTP allows user to check the current time of R2000 Dual and also synchronize the router time with PC.

Click **Sync** button to make the router time synchronize with PC.

NTP
Status

^ Time

**System Time** 2015-01-01 09:43:23

**PC Time** 2015-12-21 16:52:52 Sync

**Last Update Time** Not Updated

### 3.20 Services > SMS

This section allows users to set the SMS parameters.

SMS
SMS Testing

^ SMS Management Settings

**Enable** ON OFF

**Authentication Type** Password v ?

**Phone Number**  ?

SMS		
Item	Description	Default
Enable SMS Management	Click to enable SMS Management function.	ON
Authentication Type	Select Authentication Type from "Password", "Phonenum", "Both". Password: use the same username and password as WEB manager for authentication. For example, the format of the SMS should be "username: password; cmd1; cmd2; ..." <b>Note:</b> Set the WEB manager password in <b>3.30 System &gt; User Management</b> section. Phonenum: use the Phone number for authenticating, user should set the Phone Number that is allowed for SMS management. The format of the SMS should be "cmd1; cmd2; ..." Both: use both the "Password" and "Phonenum" for authentication. User	Passwo rd

SMS		
Item	Description	Default
	should set the Phone Number that is allowed for SMS management. The format of the SMS should be "username: password; cmd1; cmd2; ..."	
Phone Number	Set the Phone Number that is allowed for SMS management, and use ';' to separate each number.	Null

User can test the current SMS service whether it is available in this section.

SMS
SMS Testing

^ SMS Testing

**Phone Number**

**Message**

**Result**

Send

SMS Testing		
Item	Description	Default
Phone Number	Enter the specified phone number which will receive the SMS from R2000 Dual Router.	Null
Message	Enter the message that R2000 Dual Router will sent it to the specified phone number.	Null
Result	The result of the SMS test will display in the result box.	Null

## 3.21 Services > Email

R2000 Dual's Email function support send the event notifications in an Email to specified recipients.

Email

^ Email Settings

Enable  ON  OFF

Outgoing Server

Server Port

Timeout  ?

Username

Password

From

Subject

Email		
Item	Description	Default
Enable	Click to enable Email function.	Disable
Outgoing server	Enter the SMTP server IP Address or domain name.	Null
Server port	Enter the SMTP server port.	25
Timeout	The max time for sending email to SMTP server. When the server doesn't receive the email over this time, it will try to resend.	10
Username	The username which has been registered from SMTP server.	Null
Password	The password of username.	Null
From	The source address of the email.	Null
Subject	The subject of this email.	Null



### 3.22 Services > SSH

This section allow user to configure SSH parameter.

SSH		
Item	Description	Default
Enable	Enable the function that user can access R2000 Dual Router via SSH.	OFF
Port	Set the port of the SSH access.	22
Disable Password Logins	Switch to “ON” and disable password logins, so that user cannot access R2000 Dual via SSH. In this situation, you should import the authorized key into R2000 Dual in <b>Keys Management</b> part for accessing R2000 Dual. Switch to “OFF”, you can access R2000 Dual via SSH normally.	OFF

Keys Management	
Item	Description
Authorized Keys	Effective when <b>SSH &gt; Disable Password Logins</b> is “ON”. Select a key file from PC, then click  button to import the key file in R2000 Dual. So that you can access R2000 Dual via SSH without password.



### 3.23 Services > Web Server

This section allows users to modify the parameters of Web Server.

The screenshot shows the 'Web Server' configuration page with the 'Certificate Management' tab selected. Under the 'General Settings' section, there are two input fields: 'HTTP Port' with the value '80' and 'HTTPS Port' with the value '443'. Each field has a help icon (question mark) to its right.

Basic @ Web Server		
Item	Description	Default
HTTP Port	Enter the HTTP port number you want to change in R2000 Dual's Web Server. On a Web server, port 80 is the port that the server "listens to" or expects to receive from a Web client. If you configure the router with other HTTP Port number except 80, only adding that port number then you can login R2000 Dual's Web Server.	80
HTTPS Port	Enter the HTTPS port number you want to change in R2000 Dual's Web Server. On a Web server, port 443 is the port that the server "listens to" or expects to receive from a Web client. If you configure the router with other HTTPS Port number except 443, only adding that port number then you can login R2000 Dual's Web Server. <b>Note:</b> HTTPS is more secure than HTTP. In many cases, clients may be exchanging confidential information with a server, which needs to be secured in order to prevent unauthorized access. For this reason, HTTP was developed by Netscape corporation to allow authorization and secured transactions.	443
Login Timeout (s)	Enter the Login timeout you want to change in R2000 Dual's Web Server. After "Login Timeout", R2000 Dual will force to log out the Web GUI and then you need to re-login again to Web GUI.	1800

This section allows users to import the certificate file into the route.

The screenshot shows the 'Web Server' configuration page with the 'Certificate Management' tab selected. Under the 'Import Certificate' section, there is a dropdown menu for 'Import Type' set to 'CA'. Below it, there is a section for 'HTTPS Certificate' with a 'Choose File' button, the text 'No file chosen', and an 'Import' button.

#### Certificate Management

Item	Description	Default
Import Type	Select from "CA" and "Private Key". CA: a digital certificate issued by CA center. Private Key: a private key file.	CA
HTTPS Certificate	Click "Browse" to select the certificate file in your computer, and then click "Import" to import this file into your router.	

## 3.24 Services > Advanced

This section allows users to configure system and reboot.

### System

System
Reboot

**^ System Settings**

Device Name

?

User LED Type

?

System @ Advanced		
Item	Description	Default
Device Name	Set the device name to distinguish different devices you have installed. Valid characters: a-z, A-Z, 0-9, ., -.	router
User LED Type	Select from "None", "OpenVPN", "IPsec" and "WiFi".	SIM

### Reboot

System
Reboot

**^ Periodic Reboot Settings**

Periodic Reboot

?

Daily Reboot Time

?

Reboot		
Item	Description	Default
Periodic Reboot	Set the reboot period of the router, 0 means disable.	0
Daily Reboot Time	Set the daily reboot time of the router, you should follow the format as HH:MM, in 24h time frame, otherwise the data will be invalid. Leave it empty means disable.	Null

### 3.25 System > Debug

This section allow user to check and download the syslog details.

Syslog

^ Syslog Details

Log Level Debug v

Filtering  ?

Manual Refresh v
Clear
Refresh

^ Syslog Files

Index	File Name	File Size	Last Modification

^ System Diagnostic Data

System Diagnostic Data Generate

System Diagnostic Data Download

Syslog Details @ Syslog		
Item	Description	Default
Log Level	Select form “Debug”, “Info”, “Notice”, “Warn”, “Error” which from low to high. The lower level will output more syslog in detail.	Debug
Filtering	Log will be filtered according to the Filter Message that the user set. Click the Refresh button, the filtered log will be displayed in the follow box. Use “&” to separate more than one filter message, such as “keyword1&keyword2”.	Null

Refresh	Select from “Manual Refresh”, “5 Seconds”, “10 Seconds”, “20 Seconds”and“30 Seconds”. User can select these intervals to refresh the log information displayed in the follow box. Select “manual refresh”, user should click the refresh button to refresh the syslog.	Manual Refresh
<b>Syslog Files List @ Syslog</b>		
Syslog Files List	It can show at most 5 syslog files in the list, the files’ name range from message0 to message 4. And the newest syslog file will be placed on the top of the list.	/
<b>System Diagnosing Data @ Syslog</b>		
Generate	Click to generate the syslog diagnosing file.	/
Download	Click to download system diagnosing file.	/

### 3.26 System > Update

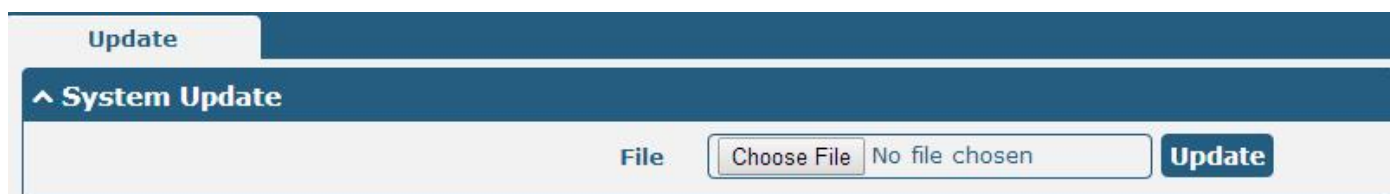

Update		
Item	Description	Default
System Update	Click “Browse” button to select the correct firmware in your PC, and then click “Update” button to update. After updating successfully, you need to click “save and apply”, and then reboot the router to take effect.	Null

### 3.27 System > APP Center

This section allow user to add a new function to R2000 Dual Router. And the new function will be in the form of an APP file which could be installed in R2000 Dual Router. In general, the App which had installed will display in **Service** section. Other VPN APP will show in **VPN** section after installing.

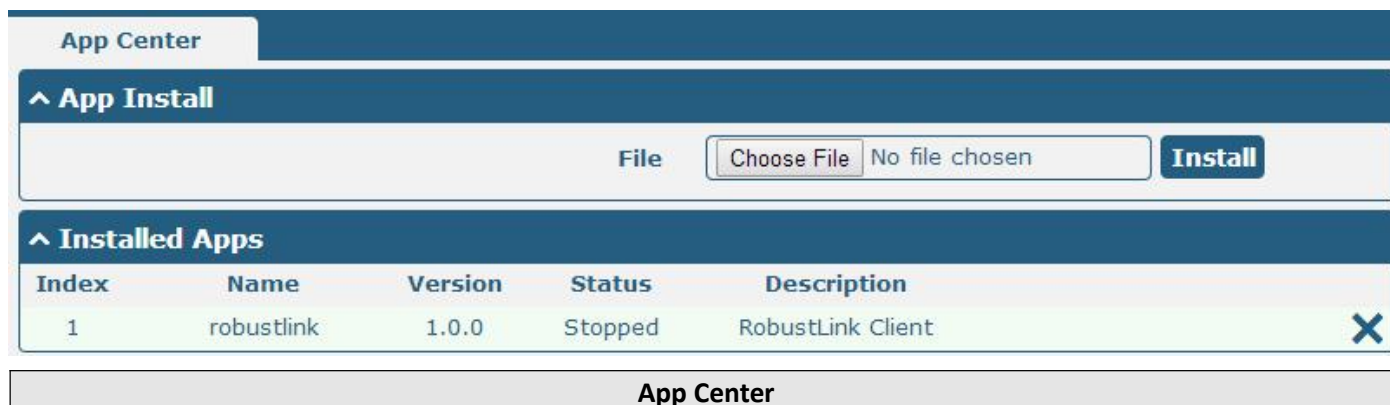

Item	Description	Default
File	Choose the correct App file from your PC, and click <b>Install</b> button to import to R2000 Dual Router. File format: xxx.rpk, e.g. r2000-robustlink-1.0.0.rpk.	/
Install Apps	Those Apps which had installed in R2000 Dual will be listed in <b>Installed Apps</b> .	Null
Index	Show the index of the App.	Null
Name	Show the name of the App.	Null
Version	Show the version of the App.	Null
Status	Show the Status of the App.	Null
Description	Show the description of the App.	Null

### 3.28 System > Tools

This section provides users three tools: Ping, Traceroute and Sniffer.

Ping
At Debug
Traceroute
Sniffer

^ Ping

**IP Address**

**Number of Request**

**Timeout**

**Local IP**

Start
Stop

**Ping @ Tools**

Item	Description	Default
IP address	Enter the ping destination IP address or domain name.	Null
Number of requests	Specify the number of ping requests.	5
Timeout	Specify timeout of ping request.	1
Local IP	Specify the local IP from cellular WAN, Ethernet WAN or Ethernet LAN. Null stands for selecting local IP address from these three automatically.	Null
Start	Click this button to start ping request, and the log will be displayed in the follow box.	Null
Stop	Click this button to stop ping request.	

Ping
At Debug
Traceroute
Sniffer

^ At Debug

**Command**

**Result**

Send

At Debug @ Tools	
Item	Description
Command	Enter a At command in Command box, then click <span style="background-color: #004a7c; color: white; padding: 2px 5px; border-radius: 3px;">Send</span> button to send the At command to the cellular module.
Result	It will display the AT commands which respond from the cellular module in this box.

Ping
At Debug
Traceroute
Sniffer

^ Traceroute

Trace Address

Trace Hops

Trace Timeout

Start
Stop

Traceroute @ Tools		
Item	Description	Default
Trace Address	Enter the trace destination IP address or domain name.	Null
Trace Hops	Specify the max trace hops. Router will stop tracing if the trace hops has met max value no matter the destination has been reached or not.	30
Trace Timeout	Specify timeout of Traceroute request.	1
Start	Click this button to start Traceroute request, and the log will be displayed in the follow box.	
Stop	Click this button to stop Traceroute request	

Ping
At Debug
Traceroute
**Sniffer**

^ Sniffer

Interface  v

Host

Packets Request

Protocol  v

Status

Start
Stop

^ Capture Files

Index	File Name	File Size	Last Modification
1	14-01-01_09-56-26.cap	16682	Wed Jan 1 09:56:30 2014

Sniffer @ Tools		
Item	Description	Default
Interface	Select form "all", "wwan1", "wwan2", "lan0", "lan1", "lan2", "lan3" and "wlan0". wwan0/wwan1: available wwan0 or wwan1 had been set as Primary Link or Backup Link. lan0~lan3: available lan0~lan3 had been set to Ethernet port. wlan0: available under Wi-Fi Client mode.	All
Host	Filter the packet that contain the specify IP address.	Null
Packets Request	Set the packet number that the router can sniffer at a time.	1000
Protocol	Select from "All", "IP", "TCP", "UDP" and "ARP".	All
Port	Set the port number for TCP or UDP that is used in sniffer.	Null
Status	Show the current status of sniffer.	Null
	Click this button to start the sniffer.	/
	Click this button to stop the sniffer. Once click the stop button, a new log file will be displayed in the follow List.	/
Capture Files	Every times of sniffer log will be saved automatically as a new file. You can find the file from this Sniffer Traffic Data List and click  to download the log, click  to delete the log file. It can cache a maximum of 5 files.	Null



## 3.29 System > Profile

This section allows users to import or export the configuration file, and restore the router to factory default setting.

Profile

^ Import Configuration File

Import Type Keep Other Configs v ?

XML Configuration File  Browse... Import

^ Export Configuration File

Export Type Full v ?

XML Configuration File Generate

^ Factory Configuration

Factory Configuration Restore

Import Configuration File @ Profile		
Item	Description	Default
Import Type	Define what to do about the configs that is not contained in the imported file. There are two Import Types: Keep Other Configs: Keep other configuration unchanged when import XML configuration file. Set Others To Default: Set other configuration to factory default when import XML configuration file.	Keep Other Configs
XML Configuration File	Click "Browse" to select the XML file in your computer, and then click "Import" to import this file into your router.	
Export Configuration File @ Profile		
Export Type	There are four export Types : Essential: export the configuration file that only include enabled features. Essential && Detailed: export the configuration file that only include enabled features, and attach extra information such as <b>range</b> and <b>default</b> setting of those enable config option. Full: export the configuration file of all features; include both the enabled and disabled features. Full && Detailed: export the configuration file of all features, and attach extra information such as <b>range</b> and <b>default</b> setting of every config option.	Full
Export	Click "Export" and the configuration will be showed in the new popup browser window, then you can save it as a XML file.	
Factory Configuration @ Profile		
Restore	Click the "Restore" button to restore the router to factory default setting.	

### 3.30 System > User Management

This section allows users to modify or add management user accounts.

Super User
Common User

^ Super User Settings

Old Password

?

New Password

?

Confirm Password

?

Super User		
Item	Description	Default
Super User	One router has only one super user account. Under this account, user has the highest authority include modify, add and manage those user accounts.	/
Old Password	The old password of super user which default is "admin", valid characters: a-z, A-Z, 0-9, @, ., -, #, \$, *.	Null
New Password	Enter a new password for the super user, valid characters: a-z, A-Z, 0-9, @, ., -, #, \$, *.	Null
Confirm Password	Enter the new password again which had added in New Password item.	Null

Super User
Common User

^ Common Users Settings

Index
Role
Username
+

Click the + button to add a new common user.

**Note:** One router has 5 common user accounts at most.

Common User

^ Common Users Settings

Index

Role

v

Username

Password

Common User
-------------

Item	Description	Default
Role	Select from "Visitor" and "Editor". Visitor: Users only can view the configuration of router under this level; Editor: Users can view and set the configuration of router under this level.	Visitor
Username	Set the Username. Valid characters: a-z, A-Z, 0-9, ., -.	Null
Password	Set the password which at least contains 5 characters. Valid characters: a-z, A-Z, 0-9, @, ., -, #, \$, *.	Null

## Chapter 4 Configuration Examples

### 4.1 Cellular

#### 4.1.1 Cellular Backup

This section shows users how to configure the primary and backup SIM card of Cellular Dial-up.

**Go to Interface > Link Manager > General Setting**

Select WWAN1 as Primary Link and WWAN2 as Backup Link, set the Backup Mode to Warm Backup.

With the setting above, WWAN1 is the primary link, all the data business will choose WWAN1 to transmit. WWAN2 is always online for backup. When WWAN1 link disconnect, the data business will choose WWAN2 to transmit.

The screenshot shows the 'Link Manager' interface with the 'Status' tab selected. Under 'General Settings', the 'Primary Link' is set to WWAN1, 'Backup Link' is WWAN2, and 'Backup Mode' is Warm Backup. The 'Emergency Reboot' toggle is currently turned OFF. Below this is the 'Link Settings' table:

Index	Type	Description	Connection Type	
1	WWAN1		DHCP	
2	WWAN2		DHCP	
3	WAN		Static	
4	WLAN		DHCP	

Click to set the WWAN1's parameter according to the current ISP.

### Link Manager

#### ^ General Settings

Index	<input type="text" value="1"/>
Type	<input type="text" value="WWAN1"/> v
Description	<input type="text"/>

#### ^ WWAN Settings

Automatic APN Selection	<input checked="" type="checkbox"/> ON <input type="checkbox"/> OFF
Dialup Number	<input type="text" value="*99***1#"/>
Authentication Type	<input type="text" value="Auto"/> v
Aggressive Reset	<input type="checkbox"/> ON <input checked="" type="checkbox"/> OFF ?
Switch SIM By Data Allowance	<input type="checkbox"/> ON <input checked="" type="checkbox"/> OFF ?
Data Allowance	<input type="text" value="0"/> ?
Billing Day	<input type="text" value="1"/> ?

#### ^ Ping Detection Settings ?

Enable	<input checked="" type="checkbox"/> ON <input type="checkbox"/> OFF
Primary Server	<input type="text" value="8.8.8.8"/>
Secondary Server	<input type="text"/>
Interval	<input type="text" value="300"/> ?
Retry Interval	<input type="text" value="5"/> ?
Timeout	<input type="text" value="3"/> ?
Max Ping Tries	<input type="text" value="3"/> ?

#### ^ Advanced Settings

MTU	<input type="text" value="1500"/>
Overridden Primary DNS	<input type="text"/>
Overridden Secondary DNS	<input type="text"/>

The modifications will take effect after click "Submit" and "save and apply" button.

## Go to Interface &gt; Cellular

Cellular		Status		
^ Advanced Cellular Settings				
Index	SIM Card	Phone Number	Network Type	Band Select Type
1	SIM1		Auto	All
2	SIM2		Auto	All

Click  to set the SIM card's parameter according to the application requirement.

**Cellular**

^ General Settings

Index:

SIM Card:

Phone Number:

Extra AT Cmd:  ?

^ Cellular Network Settings

Network Type:  ?

Band Select Type:  ?

The modifications will take effect after click “Submit” and “save and apply” button.

## 4.1.2 SMS Remote Control

R2000 Dual supports remote control via SMS. User can use following commands to get the status of R2000 Dual, and set all the parameters of R2000 Dual.

There are three authentication types for SMS control. You can select from “Password”, “Phonenum” and “Both”.

### An SMS command has following structure:

1. Password mode—Username: Password;cmd1;cmd2;cmd3; ...cmdn (available every phone number).
2. Phonenum mode--cmd1; cmd2; cmd3; ... cmdn (available when the SMS was sent from the phone number which had been added in R2000 Dual's phone group).
3. Both mode-- Username: Password;cmd1;cmd2;cmd3; ...cmdn (available when the SMS was sent from the phone number which had been added in R2000 Dual's phone group).

### SMS command Explanation:

1. User name and Password: it uses the same username and password as WEB manager for authentication.
2. cmd1, cmd2, cmd3 to Cmdn, the command format is the same as the CLI command, more details about CLI cmd please refer to **chapter 5 Introductions for CLI**.

**Note:** Download the configure XML file from the configured web browser. The format of SMS control command can refer to the data of the XML file.

Go to System > Profile > Export Configuration File, select Export type as **Full**, click **Generate** to generate the XML file and then click **Export** to export the XML file.

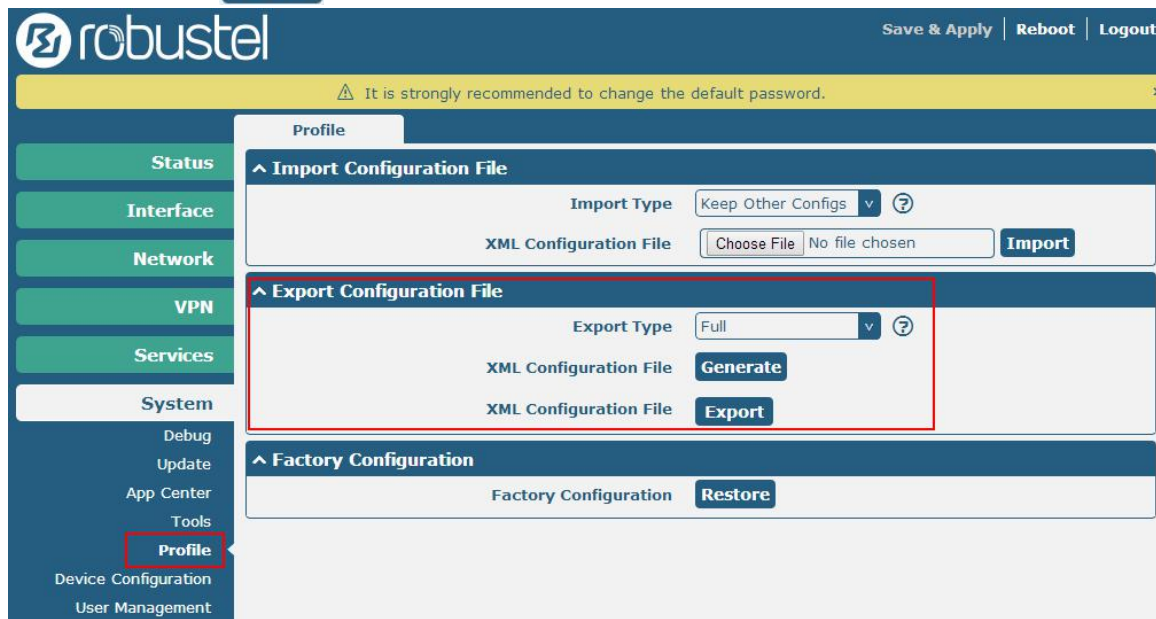

**XML command:**

```
<lan>
<network max_entry_num="2">
<id>1</id>
<interface>lan0</interface>
<ip>172.16.99.11</ip>
<netmask>255.255.0.0</netmask>
<mtu>1500</mtu>
```

**SMS cmd:**

```
set lan network 1 interface lan0
set lan network 1 ip 172.16.99.11
set lan network 1 netmask 255.255.0.0
set lan network 1 mtu 1500
```

3. The semicolon character (;) is used to separate more than one commands packed in a single SMS.

4. E.g.

**admin:admin;status system**

In this command, username is admin, password is admin, and the function of the command is getting the system status.

**SMS received:**

```
hardware_version = 1.0
firmware_version = "1.2.0 (Rev 399)"
kernel_version = 3.10.49
device_model = R2000 Dual
serial_number = 15090140040008
```

```
uptime = "0 days, 00:04:07"
system_time = "Tue Dec 22 15:02:36 2015"
```

**admin:admin;reboot**

In this command, username is admin, password is admin, and the command is reboot R2000 Dual.

**SMS received:**

OK

**admin:admin;set firewall remote\_ssh\_access false;set firewall remote\_telnet\_access false**

In this command, username is admin, password is admin, and the function of the command is disabling the remote\_ssh and remote\_telnet access.

**SMS received:**

OK

OK

**admin:admin; set lan network 1 interface lan0;set lan network 1 ip 172.16.99.11;set lan network 1 netmask 255.255.0.0;set lan network 1 mtu 1500**

In this command, username is admin, password is admin, and the function of those commands is configuring the LAN parameter.

**SMS received:**

OK

OK

OK

OK

## 4.2 Network

### 4.2.1 IPsec VPN

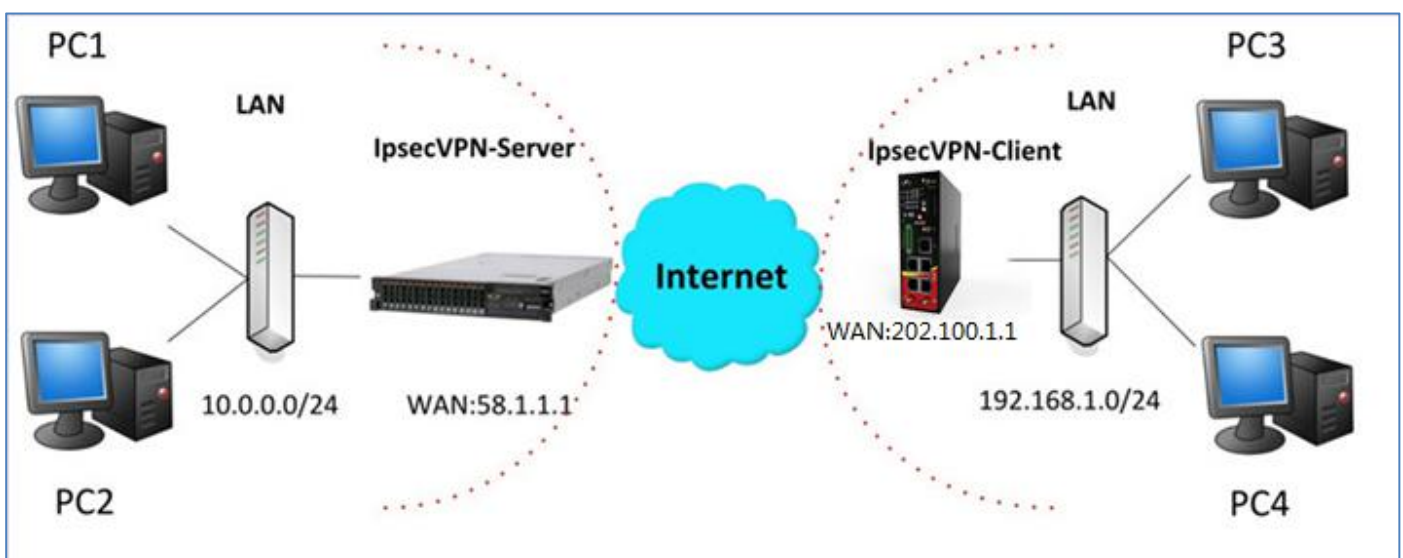



**Note:** the configuration of server and client is as follows.

**IPsecVPN\_SERVER:**

**Cisco 2811:**

```

Router>enable
Router#config
Configuring from terminal, memory, or network [terminal]?
Enter configuration commands, one per line. End with CNTL/Z.
Router(config)#crypto isakmp policy 10
Router(config-isakmp)#?
  authentication  Set authentication method for protection suite
  encryption     Set encryption algorithm for protection suite
  exit           Exit from ISAKMP protection suite configuration mode
  group          Set the Diffie-Hellman group
  hash           Set hash algorithm for protection suite
  lifetime       Set lifetime for ISAKMP security association
  no             Negate a command or set its defaults
Router(config-isakmp)#encryption 3des
Router(config-isakmp)#hash md5
Router(config-isakmp)#authentication pre-share
Router(config-isakmp)#group 2
Router(config-isakmp)#exit
Router(config)#crypto isakmp ?
  client  Set client configuration policy
  enable  Enable ISAKMP
  key     Set pre-shared key for remote peer
  policy  Set policy for an ISAKMP protection suite
Router(config)#crypto isakmp key cisco address 0.0.0.0 0.0.0.0

Router(config)#crypto ?
  dynamic-map  Specify a dynamic crypto map template
  ipsec       Configure IPSEC policy
  isakmp      Configure ISAKMP policy
  key         Long term key operations
  map        Enter a crypto map
Router(config)#crypto ipsec ?
  security-association  Security association parameters
  transform-set         Define transform and settings
Router(config)#crypto ipsec transform-set Trans ?
  ah-md5-hmac  AH-HMAC-MD5 transform
  ah-sha-hmac  AH-HMAC-SHA transform
  esp-3des    ESP transform using 3DES(EDE) cipher (168 bits)
  esp-aes     ESP transform using AES cipher
  esp-des     ESP transform using DES cipher (56 bits)
  esp-md5-hmac  ESP transform using HMAC-MD5 auth
  esp-sha-hmac  ESP transform using HMAC-SHA auth
Router(config)#crypto ipsec transform-set Trans esp-3des esp-md5-hmac

Router(config)#ip access-list extended vpn
Router(config-ext-nacl)#permit ip 10.0.0.0 0.0.0.255 192.168.1.0 0.0.0.255
Router(config-ext-nacl)#exit

Router(config)#crypto map cry-map 10 ipsec-isakmp
% NOTE: This new crypto map will remain disabled until a peer
and a valid access list have been configured.
Router(config-crypto-map)#match address vpn
Router(config-crypto-map)#set transform-set Trans
Router(config-crypto-map)#set peer 202.100.1.1
Router(config-crypto-map)#exit

Router(config)#interface fastEthernet 0/0
Router(config-if)#ip address 58.1.1.1 255.255.255.0
Router(config-if)#cr
Router(config-if)#crypto map cry-map
*Jan 3 07:16:26.785: %CRYPTO-6-ISAKMP_ON_OFF: ISAKMP is ON

```

## IPsecVPN\_CLIENT:

### VPN > IPsec > Tunnel

General Tunnel Status x509

^ Tunnel Settings

Index	Enable	Description

Then click **+**.

Tunnel

^ Tunnel Settings

Index: 1

Enable: **ON** OFF

Description:

Gateway: 58.1.1.1 ?

Mode: Tunnel v

Protocol: ESP v

Local Subnet: 192.168.1.0 ?

Remote Subnet: 255.255.255.0 ?

^ IKE Settings

Negotiation Mode: Main v

Authentication Algorithm: MD5 v

Encrypt Algorithm: 3DES v

IKE DH Group: MODP(1024) v

Authentication Type: PSK v

PSK Secret: ●●●●

Local ID Type: Default v

Remote ID Type: Default v

IKE Lifetime: 86400 ?

^ SA Settings

Encrypt Algorithm: 3DES v

Authentication Algorithm: MD5 v

PFS Group: MODP(1024) v

SA Lifetime: 28800 ?

DPD Interval: 60 ?

DPD Failures: 180 ?

^ Advanced Settings

Enable Compression: **ON** OFF

The modification will take effect after "Submit > Save & Apply > Reboot".

The comparison between server and client is as following picture:

```

Server(Cisco 2811)
Router>enable
Router#config
Configuring from terminal, memory, or network [terminal]?
Enter configuration commands, one per line. End with CNTL/Z.
Router(config)#crypto isakmp policy 10
Router(config-isakmp)#?
authentication Set authentication method for protection suite
encryption Set encryption algorithm for protection suite
exit Exit from ISAKMP protection suite configuration mode
group Set the Diffie-Hellman group
hash Set hash algorithm for protection suite
lifetime Set lifetime for ISAKMP security association
no Negate a command or set its defaults
Router(config-isakmp)#encryption 3des
Router(config-isakmp)#hash md5
Router(config-isakmp)#authentication pre-share
Router(config-isakmp)#group 2
Router(config-isakmp)#exit
Router(config)#crypto isakmp ?
client Set client configuration policy
enable Enable ISAKMP
key Set pre-shared key for remote peer
policy Set policy for an ISAKMP protection suite
Router(config)#crypto isakmp key cisco address 0.0.0.0 0.0.0.0

Router(config)#crypto ?
dynamic-map Specify a dynamic crypto map template
ipsec Configure IPSEC policy
isakmp Configure ISAKMP policy
key Long term key operations
map Enter a crypto map
Router(config)#crypto ipsec ?
security-association Security association parameters
transform-set Define transform and settings
Router(config)#crypto ipsec transform-set Trans ?
ah-md5-hmac AH-HMAC-MD5 transform
ah-sha-hmac AH-HMAC-SHA transform
esp-3des ESP transform using 3DES (EDE) cipher (168 bits)
esp-aes ESP transform using AES cipher
esp-des ESP transform using DES cipher (56 bits)
esp-md5-hmac ESP transform using HMAC-MD5 auth
esp-sha-hmac ESP transform using HMAC-SHA auth
Router(config)#crypto ipsec transform-set Trans esp-3des esp-md5-hmac

Router(config)#ip access-list extended vpn
Router(config-ext-nacl)#permit ip 10.0.0.0 0.0.0.255 192.168.1.0 0.0.0.255
Router(config-ext-nacl)#exit

Router(config)#crypto map cry-map 10 ipsec-isakmp
% NOTE: This new crypto map will remain disabled until a peer
and a valid access list have been configured.
Router(config-crypto-map)#match address vpn
Router(config-crypto-map)#set transform-set Trans
Router(config-crypto-map)#set peer 202.100.1.1
Router(config-crypto-map)#exit

Router(config)#interface fastEthernet 0/0
Router(config-if)#ip address 58.1.1.1 255.255.255.0
Router(config-if)#cr
Router(config-if)#crypto map cry-map
*Jan 3 07:16:26.785: %CRYPTO-6-ISAKMP_ON_OFF: ISAKMP is ON
    
```

Client (R2000 Lite)

**Tunnel**

^ Tunnel Settings

Index	<input type="text" value="1"/>
Enable	<input checked="" type="checkbox"/> ON <input type="checkbox"/> OFF
Description	<input type="text"/>
Gateway	<input type="text" value="58.1.1.1"/> ?
Mode	<input type="text" value="Tunnel"/> v
Protocol	<input type="text" value="ESP"/> v
Local Subnet	<input type="text" value="192.168.1.0"/> ?
Remote Subnet	<input type="text" value="255.255.255.0"/> ?

^ IKE Settings

Negotiation Mode	<input type="text" value="Main"/> v
Authentication Algorithm	<input type="text" value="MD5"/> v
Encrypt Algorithm	<input type="text" value="3DES"/> v
IKE DH Group	<input type="text" value="MODP(1024)"/> v
Authentication Type	<input type="text" value="PSK"/> v
PSK Secret	<input type="text" value="*****"/>
Local ID Type	<input type="text" value="Default"/> v
Remote ID Type	<input type="text" value="Default"/> v
IKE Lifetime	<input type="text" value="86400"/> ?

^ SA Settings

Encrypt Algorithm	<input type="text" value="3DES"/> v
Authentication Algorithm	<input type="text" value="MD5"/> v
PFS Group	<input type="text" value="MODP(1024)"/> v
SA Lifetime	<input type="text" value="28800"/> ?
DPD Interval	<input type="text" value="60"/> ?
DPD Failures	<input type="text" value="180"/> ?

^ Advanced Settings

Enable Compression	<input type="checkbox"/> ON <input checked="" type="checkbox"/> OFF
--------------------	---

IKE Setting in Client must be consistent with server.

SA Setting in Client must be consistent with server.

## 4.2.2 OPENVPN

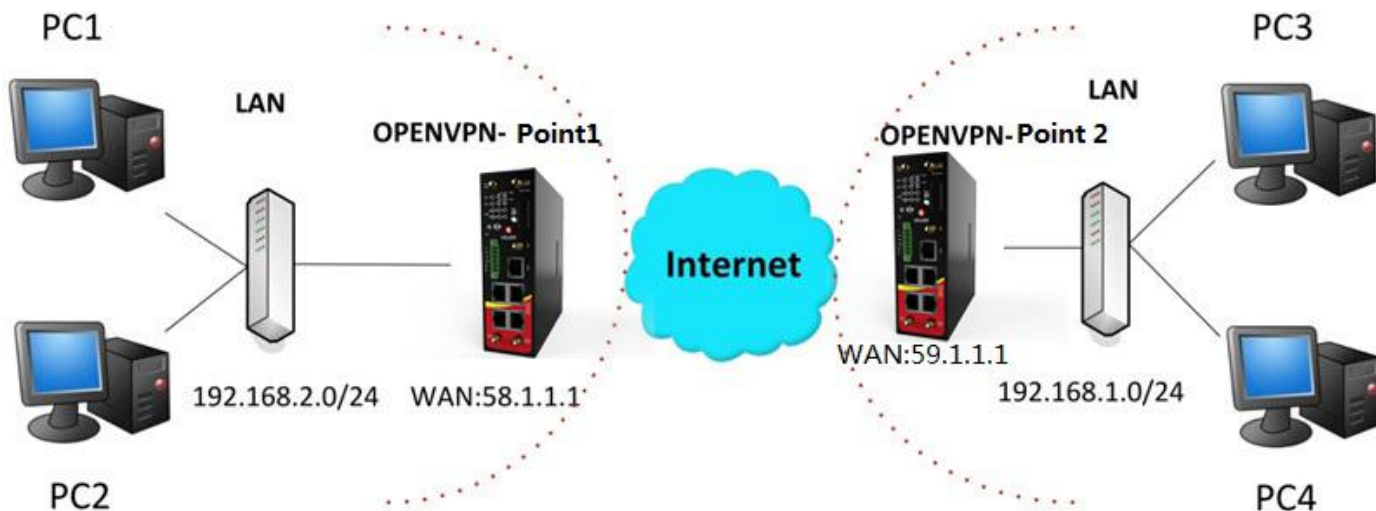

**Note:** the configuration of two points is as follows.

### OPENVPN (p2p):

#### Point 1

#### VPN > OpenVPN > OpenVPN

OpenVPN	Status	x509
^ Tunnel Settings		
Index	Enable	Description

Click **+**.



**OpenVPN**

^ Tunnel Settings

Index	<input type="text" value="1"/>
Enable	<input checked="" type="checkbox"/> ON <input type="checkbox"/> OFF
Description	<input type="text" value="OpenVPN-Point 1"/>
Mode	<input type="text" value="P2P"/> v
Protocol	<input type="text" value="UDP"/> v
Server Address	<input type="text" value="59.1.1.1"/>
Server Port	<input type="text" value="1194"/>
Interface Type	<input type="text" value="TUN"/> v
Authentication Type	<input type="text" value="None"/> v ?
Local IP	<input type="text" value="10.8.0.1"/>
Remote IP	<input type="text" value="10.8.0.2"/>
Keepalive Interval	<input type="text" value="20"/> ?
Keepalive Timeout	<input type="text" value="120"/> ?
Enable Compression	<input checked="" type="checkbox"/> ON <input type="checkbox"/> OFF
Enable NAT	<input checked="" type="checkbox"/> ON <input type="checkbox"/> OFF

^ Advanced Settings

Expert Options	<input type="text" value="route 192.168.1.0 255"/> ?
----------------	--

The modifications will take effect after click “Submit > Save & Apply”.

## Point 2

### VPN > OpenVPN > OpenVPN

OpenVPN	Status	x509
^ Tunnel Settings		
Index	Enable	Description
+		

Click .

**OpenVPN**

^ Tunnel Settings

Index	<input type="text" value="1"/>
Enable	<input checked="" type="checkbox"/> ON <input type="checkbox"/> OFF
Description	<input type="text" value="OpenVPN-Point 2"/>
Mode	<input type="text" value="P2P"/> v
Protocol	<input type="text" value="UDP"/> v
Server Address	<input type="text" value="58.1.1.1"/>
Server Port	<input type="text" value="1194"/>
Interface Type	<input type="text" value="TUN"/> v
Authentication Type	<input type="text" value="None"/> v ?
Local IP	<input type="text" value="10.8.0.2"/>
Remote IP	<input type="text" value="10.8.0.1"/>
Keepalive Interval	<input type="text" value="20"/> ?
Keepalive Timeout	<input type="text" value="120"/> ?
Enable Compression	<input checked="" type="checkbox"/> ON <input type="checkbox"/> OFF
Enable NAT	<input checked="" type="checkbox"/> ON <input type="checkbox"/> OFF

^ Advanced Settings

Expert Options  ?

The modifications will take effect after click “Submit > Save & Apply”.

The comparison between point 1 and point 2 is as following

Point 1	point 2																																																												
<div style="border: 1px solid #004a87; padding: 5px;"> <div style="background-color: #004a87; color: white; padding: 2px;"><b>OpenVPN</b></div> <div style="background-color: #004a87; color: white; padding: 2px;">^ Tunnel Settings</div> <table style="width: 100%; border-collapse: collapse;"> <tr><td style="width: 20%;">Index</td><td><input type="text" value="1"/></td></tr> <tr><td>Enable</td><td><input checked="" type="checkbox"/> ON <input type="checkbox"/> OFF</td></tr> <tr><td>Description</td><td><input type="text" value="OpenVPN-Point 1"/></td></tr> <tr><td>Mode</td><td><input type="text" value="P2P"/> v</td></tr> <tr><td>Protocol</td><td><input type="text" value="UDP"/> v</td></tr> <tr><td>Server Address</td><td><input type="text" value="59.1.1.1"/></td></tr> <tr><td>Server Port</td><td><input type="text" value="1194"/></td></tr> <tr><td>Interface Type</td><td><input type="text" value="TUN"/> v</td></tr> <tr><td>Authentication Type</td><td><input type="text" value="None"/> v ?</td></tr> <tr><td>Local IP</td><td><input type="text" value="10.8.0.1"/></td></tr> <tr><td>Remote IP</td><td><input type="text" value="10.8.0.2"/></td></tr> <tr><td>Keepalive Interval</td><td><input type="text" value="20"/> ?</td></tr> <tr><td>Keepalive Timeout</td><td><input type="text" value="120"/> ?</td></tr> <tr><td>Enable Compression</td><td><input checked="" type="checkbox"/> ON <input type="checkbox"/> OFF</td></tr> <tr><td>Enable NAT</td><td><input checked="" type="checkbox"/> ON <input type="checkbox"/> OFF</td></tr> </table> <div style="background-color: #004a87; color: white; padding: 2px;">^ Advanced Settings</div> <div style="border: 1px solid #ccc; padding: 2px; margin-top: 5px;">             Expert Options <input type="text" value="route 192.168.1.0 255"/> ?         </div> </div>	Index	<input type="text" value="1"/>	Enable	<input checked="" type="checkbox"/> ON <input type="checkbox"/> OFF	Description	<input type="text" value="OpenVPN-Point 1"/>	Mode	<input type="text" value="P2P"/> v	Protocol	<input type="text" value="UDP"/> v	Server Address	<input type="text" value="59.1.1.1"/>	Server Port	<input type="text" value="1194"/>	Interface Type	<input type="text" value="TUN"/> v	Authentication Type	<input type="text" value="None"/> v ?	Local IP	<input type="text" value="10.8.0.1"/>	Remote IP	<input type="text" value="10.8.0.2"/>	Keepalive Interval	<input type="text" value="20"/> ?	Keepalive Timeout	<input type="text" value="120"/> ?	Enable Compression	<input checked="" type="checkbox"/> ON <input type="checkbox"/> OFF	Enable NAT	<input checked="" type="checkbox"/> ON <input type="checkbox"/> OFF	<div style="border: 1px solid #004a87; padding: 5px;"> <div style="background-color: #004a87; color: white; padding: 2px;"><b>OpenVPN</b></div> <div style="background-color: #004a87; color: white; padding: 2px;">^ Tunnel Settings</div> <table style="width: 100%; border-collapse: collapse;"> <tr><td style="width: 20%;">Index</td><td><input type="text" value="1"/></td></tr> <tr><td>Enable</td><td><input checked="" type="checkbox"/> ON <input type="checkbox"/> OFF</td></tr> <tr><td>Description</td><td><input type="text" value="OpenVPN-Point 2"/></td></tr> <tr><td>Mode</td><td><input type="text" value="P2P"/> v</td></tr> <tr><td>Protocol</td><td><input type="text" value="UDP"/> v</td></tr> <tr><td>Server Address</td><td><input type="text" value="58.1.1.1"/></td></tr> <tr><td>Server Port</td><td><input type="text" value="1194"/></td></tr> <tr><td>Interface Type</td><td><input type="text" value="TUN"/> v</td></tr> <tr><td>Authentication Type</td><td><input type="text" value="None"/> v ?</td></tr> <tr><td>Local IP</td><td><input type="text" value="10.8.0.2"/></td></tr> <tr><td>Remote IP</td><td><input type="text" value="10.8.0.1"/></td></tr> <tr><td>Keepalive Interval</td><td><input type="text" value="20"/> ?</td></tr> <tr><td>Keepalive Timeout</td><td><input type="text" value="120"/> ?</td></tr> <tr><td>Enable Compression</td><td><input checked="" type="checkbox"/> ON <input type="checkbox"/> OFF</td></tr> <tr><td>Enable NAT</td><td><input checked="" type="checkbox"/> ON <input type="checkbox"/> OFF</td></tr> </table> <div style="background-color: #004a87; color: white; padding: 2px;">^ Advanced Settings</div> <div style="border: 1px solid #ccc; padding: 2px; margin-top: 5px;">             Expert Options <input type="text" value="route 192.168.2.0 255"/> ?         </div> </div>	Index	<input type="text" value="1"/>	Enable	<input checked="" type="checkbox"/> ON <input type="checkbox"/> OFF	Description	<input type="text" value="OpenVPN-Point 2"/>	Mode	<input type="text" value="P2P"/> v	Protocol	<input type="text" value="UDP"/> v	Server Address	<input type="text" value="58.1.1.1"/>	Server Port	<input type="text" value="1194"/>	Interface Type	<input type="text" value="TUN"/> v	Authentication Type	<input type="text" value="None"/> v ?	Local IP	<input type="text" value="10.8.0.2"/>	Remote IP	<input type="text" value="10.8.0.1"/>	Keepalive Interval	<input type="text" value="20"/> ?	Keepalive Timeout	<input type="text" value="120"/> ?	Enable Compression	<input checked="" type="checkbox"/> ON <input type="checkbox"/> OFF	Enable NAT	<input checked="" type="checkbox"/> ON <input type="checkbox"/> OFF
Index	<input type="text" value="1"/>																																																												
Enable	<input checked="" type="checkbox"/> ON <input type="checkbox"/> OFF																																																												
Description	<input type="text" value="OpenVPN-Point 1"/>																																																												
Mode	<input type="text" value="P2P"/> v																																																												
Protocol	<input type="text" value="UDP"/> v																																																												
Server Address	<input type="text" value="59.1.1.1"/>																																																												
Server Port	<input type="text" value="1194"/>																																																												
Interface Type	<input type="text" value="TUN"/> v																																																												
Authentication Type	<input type="text" value="None"/> v ?																																																												
Local IP	<input type="text" value="10.8.0.1"/>																																																												
Remote IP	<input type="text" value="10.8.0.2"/>																																																												
Keepalive Interval	<input type="text" value="20"/> ?																																																												
Keepalive Timeout	<input type="text" value="120"/> ?																																																												
Enable Compression	<input checked="" type="checkbox"/> ON <input type="checkbox"/> OFF																																																												
Enable NAT	<input checked="" type="checkbox"/> ON <input type="checkbox"/> OFF																																																												
Index	<input type="text" value="1"/>																																																												
Enable	<input checked="" type="checkbox"/> ON <input type="checkbox"/> OFF																																																												
Description	<input type="text" value="OpenVPN-Point 2"/>																																																												
Mode	<input type="text" value="P2P"/> v																																																												
Protocol	<input type="text" value="UDP"/> v																																																												
Server Address	<input type="text" value="58.1.1.1"/>																																																												
Server Port	<input type="text" value="1194"/>																																																												
Interface Type	<input type="text" value="TUN"/> v																																																												
Authentication Type	<input type="text" value="None"/> v ?																																																												
Local IP	<input type="text" value="10.8.0.2"/>																																																												
Remote IP	<input type="text" value="10.8.0.1"/>																																																												
Keepalive Interval	<input type="text" value="20"/> ?																																																												
Keepalive Timeout	<input type="text" value="120"/> ?																																																												
Enable Compression	<input checked="" type="checkbox"/> ON <input type="checkbox"/> OFF																																																												
Enable NAT	<input checked="" type="checkbox"/> ON <input type="checkbox"/> OFF																																																												

picture:

### 4.2.3 GRE VPN

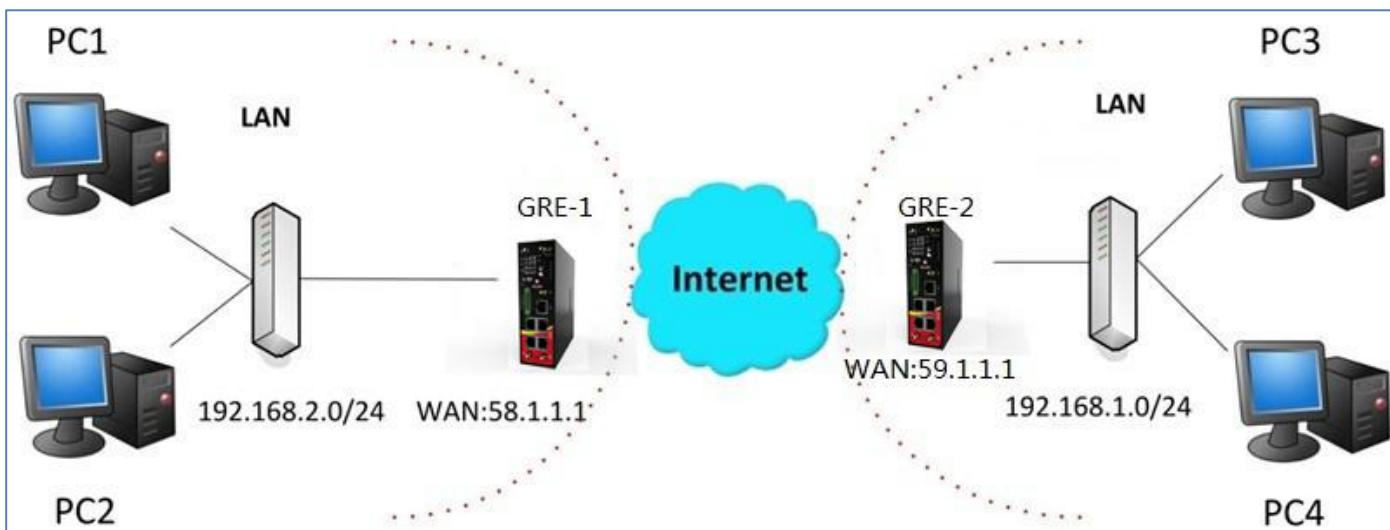

#### VPN > GRE > GRE

GRE				Status
^ Tunnel Settings				
Index	Enable	Description	Remote IP Address	
				+

Click **+** .

GRE-1:

^ Tunnel Settings	
Index	<input type="text" value="1"/>
Enable	<input checked="" type="checkbox"/> ON <input type="checkbox"/> OFF
Description	<input type="text" value="GRE-1"/>
Remote IP Address	<input type="text" value="59.1.1.1"/>
Local Virtual IP Address	<input type="text" value="10.8.0.1"/>
Remote Virtual IP Address	<input type="text" value="10.8.0.2"/>
Enable Default Route	<input type="checkbox"/> ON <input checked="" type="checkbox"/> OFF
Enable NAT	<input type="checkbox"/> ON <input checked="" type="checkbox"/> OFF
Secrets	<input type="password" value="*****"/>

The modifications will take effect after click “Submit > Save & Apply”.

GRE-2:



^ Tunnel Settings

Index

Enable  ON  OFF

Description

Remote IP Address

Local Virtual IP Address

Remote Virtual IP Address

Enable Default Route  ON  OFF

Enable NAT  ON  OFF

Secrets

The modifications will take effect after click “Submit > Save & Apply”.

The comparison between point 1 and point 2 is as following picture:

GRE-1	GRE-2
<div style="border: 1px solid #004a7c; padding: 5px;"> <div style="background-color: #004a7c; color: white; padding: 2px 5px;">^ Tunnel Settings</div> <p>Index <input type="text" value="1"/></p> <p>Enable <input checked="" type="checkbox"/> ON <input type="checkbox"/> OFF</p> <p>Description <input type="text" value="GRE-1"/></p> <p>Remote IP Address <input style="border: 2px solid red;" type="text" value="59.1.1.1"/> GRE-1 public IP</p> <p>Local Virtual IP Address <input style="border: 2px solid red;" type="text" value="10.8.0.1"/> GRE-1 tunnel IP</p> <p>Remote Virtual IP Address <input style="border: 2px solid red;" type="text" value="10.8.0.2"/> GRE-2 tunnel IP</p> <p>Enable Default Route <input type="checkbox"/> ON <input checked="" type="checkbox"/> OFF</p> <p>Enable NAT <input type="checkbox"/> ON <input checked="" type="checkbox"/> OFF <span style="color: red;">set the same secret as GRE-2</span></p> <p>Secrets <input style="border: 2px solid red;" type="text" value="*****"/></p> </div>	<div style="border: 1px solid #004a7c; padding: 5px;"> <div style="background-color: #004a7c; color: white; padding: 2px 5px;">^ Tunnel Settings</div> <p>Index <input type="text" value="1"/></p> <p>Enable <input checked="" type="checkbox"/> ON <input type="checkbox"/> OFF</p> <p>Description <input type="text" value="GRE-2"/></p> <p>Remote IP Address <input style="border: 2px solid red;" type="text" value="58.1.1.1"/> GRE-2 public IP</p> <p>Local Virtual IP Address <input style="border: 2px solid red;" type="text" value="10.8.0.2"/> GRE-2 tunnel IP</p> <p>Remote Virtual IP Address <input style="border: 2px solid red;" type="text" value="10.8.0.1"/> GRE-1 tunnel IP</p> <p>Enable Default Route <input type="checkbox"/> ON <input checked="" type="checkbox"/> OFF</p> <p>Enable NAT <input type="checkbox"/> ON <input checked="" type="checkbox"/> OFF <span style="color: red;">set the same secret as GRE-1</span></p> <p>Secrets <input style="border: 2px solid red;" type="text" value="*****"/></p> </div>

## Chapter 5 CLI Introduction

### 5.1 What's CLI

The R2000 Dual command-line interface (CLI) is a software interface providing another way to set the parameters of equipment from the [SSH](#) or through a [telnet](#) network connection.

**Route login:**

Router login: admin

Password: admin

#

**CLI commands:**

# ? (**Note:** the '?' won't display on the page.)

!	Comments
add	Add a list entry of configuration
clear	Clear statistics
config	Configuration operation
debug	Output debug information to the console
del	Delete a list entry of configuration
exit	Exit from the CLI
help	Display an overview of the CLI syntax
ping	Send messages to network hosts
reboot	Halt and perform a cold restart
route	Static route modify dynamically, this setting will not be saved
set	Set system configuration
show	Show system configuration
status	Show running system information
tftpupdate	Update firmware using tftp
traceroute	Print the route packets trace to network host
urlupdate	Update firmware using http or ftp
ver	Show version of firmware

## 5.2 How to Use CLI Configure Router

Following is a list about the description of help and the error should be encountered in the configuring program.

Commands/tips	Description
?	Typing a question mark “?” will show you the help information.
Ctrl+c	Press these two keys at the same time, except its “copy” function but also can be used for “break” out of the setting program.
Syntax error: The command is not completed	Command is not completed.
Tick space key+ Tab key	It can help you finish you command. Example: # config (tick Enter key) Syntax error: The command is not completed # config (tick space key+ Tab key) commit                    save_and_apply    loaddefault
# config save_and_apply/ #config commit	When you finish your setting, you should enter those commands to make your setting take effect on the device. <b>Note:</b> commit and save_and_apply plays the same role.

### 5.2.1 QuickStart with Configuration Examples

The best and quickest way to master CLI is firstly to view all features from the webpage and then reading all CLI commands at a time, finally learn to configure it with some reference examples.

#### Example 1: Show current version

```
# status system
firmware_version = "2.0.0 "
kernel_version = 3.10.49
device_model = "R2000 Dual"
serial_number = 201606120001
uptime = "0 days, 06:27:39"
system_time = "Fri Jan 1 06:27:29 2016 (NTP not updated)"
```

#### Example 2: Update firmware via tftp

```
# tftpupdate (space+?)
firmware New firmware
# tftpupdate firmware (space+?)
String Firmware name
# tftpupdate firmware filename r2000-firmware-sysupgrade-unknown.bin host 192.168.100.99 //enter a new
firmware name
Downloading
R2000 Dual-firmware-s 100% |*****| 5018k 0:00:00 ETA
```

Flashing

Checking 100%

Decrypting 100%

Flashing 100%

Verifying 100%

Verify Success

upgrade success

//update success

# config save\_and\_apply

OK

// save and apply current configuration, make you configuration effect

### Example 3: Set link-manager

# set

# set(space+?)

at_over_telnet	AT Over Telnet
cellular	Cellular
ddns	Dynamic DNS
Ethernet	Ethernet
event	Event Management
firewall	Firewall
gre	GRE
IPsec	IPsec
lan	Local Area Network
link_manager	Link Manager
ntp	NTP
openvpn	OpenVPN
reboot	Automatic Reboot
robustlink	Robustlink
route	Route
sms	SMS
snmp	SNMP agent
ssh	SSH
syslog	Syslog
system	System
user_management	User Management
vrrp	VRRP
web_server	Web Server

# set link\_manager

primary_link	Primary Link
backup_link	Backup Link
backup_mode	BackSup Mode
emergency_reboot	Emergency Reboot
link	Link Settings

# set link\_manager primary\_link (space+?)

```

Enum Primary Link (wwan1/wwan2/wan/WiFi)
# set link_manager primary_link wwan1 //select "wwan1" as primary_link
OK //setting succeed
# set link_manager link 1
  type Type
  desc Description
  connection_type Connection Type
  wwan WWAN Settings
  static_addr Static Address Settings
  pppoe PPPoE Settings
  ping Ping Settings
  mtu MTU
  dns1_overridden Overridden Primary DNS
  dns2_overridden Overridden Secondary DNS
# set link_manager link 1 type wwan1
OK
# set link_manager link 1 wwan
  auto_apn Automatic APN Selection
  apn APN
  username Username
  password Password
  dialup_number Dialup Number
  auth_type Authentication Type
  aggressive_reset Aggressive Reset
  switch_by_data_allowance Switch SIM By Data Allowance
  data_allowance Data Allowance
  billing_day Billing Day
# set link_manager link 1 wwan switch_by_data_allowance true
OK
#
# set link_manager link 1 wwan data_allowance 100 //open cellular switch_by_data_traffic
OK //setting succeed
# set link_manager link 1 wwan billing_day 1 //setting specifies the day of month for billing
OK // setting succeed
...
# config save_and_apply
OK // save and apply current configuration, make you configuration effect

```

#### Example 4: CLI for setting Ethernet

```

# set Ethernet port_setting 2 port_assignment lan2 //set table2 (ETH1) as lan2
OK
# config save_and_apply //make configuration effective
OK

```

## Example 5: Set LAN IP address

```
# show lan all
network {
    id = 1
    interface = lan0
    ip = 192.168.0.1
    netmask = 255.255.255.0
    mtu = 1500
    dhcp {
        enable = true
        mode = server
        relay_server = ""
        pool_start = 192.168.0.2
        pool_end = 192.168.0.100
        netmask = 255.255.255.0
        gateway = ""
        primary_dns = ""
        secondary_dns = ""
        wins_server = ""
        lease_time = 120
        expert_options = ""
        debug_enable = false
    }
}
multi_ip {
    id = 1
    interface = lan0
    ip = 172.16.99.11
    netmask = 255.255.0.0
}
#
# set lan
network      Network Settings
multi_ip    Multiple IP Address Settings
vlan        VLAN
# set lan network 1(space+?)
interface    Interface
ip           IP Address
netmask     Netmask
mtu         MTU
dhcp        DHCP Settings
# set lan network 1 interface lan0
```

```
OK
# set lan network 1 ip 172.16.99.22           //set IP address for lan
OK                                           //setting succeed
# set lan network 1 netmask 255.255.0.0
OK
#
...
# config save_and_apply
OK                                           // save and apply current configuration, make you configuration effect
```

## Example 6: CLI for setting Cellular

```
# show cellular all
sim {
    id = 1
    card = sim1
    phone_number = ""
    extra_at_cmd = ""
    network_type = auto
    band_select_type = all
    band_gsm_850 = false
    band_gsm_900 = false
    band_gsm_1800 = false
    band_gsm_1900 = false
    band_wcdma_850 = false
    band_wcdma_900 = false
    band_wcdma_1900 = false
    band_wcdma_2100 = false
    band_lte_800 = false
    band_lte_850 = false
    band_lte_900 = false
    band_lte_1800 = false
    band_lte_1900 = false
    band_lte_2100 = false
    band_lte_2600 = false
    band_lte_1700 = false
    band_lte_700 = false
    band_tdd_lte_2600 = false
    band_tdd_lte_1900 = false
    band_tdd_lte_2300 = false
    band_tdd_lte_2500 = false
}
sim {
    id = 2
```

```

card = sim2
phone_number = ""
extra_at_cmd = ""
network_type = auto
band_select_type = all
band_gsm_850 = false
band_gsm_900 = false
band_gsm_1800 = false
band_gsm_1900 = false
band_wcdma_850 = false
band_wcdma_900 = false
band_wcdma_1900 = false
band_wcdma_2100 = false
band_lte_800 = false
band_lte_850 = false
band_lte_900 = false
band_lte_1800 = false
band_lte_1900 = false
band_lte_2100 = false
band_lte_2600 = false
band_lte_1700 = false
band_lte_700 = false
band_tdd_lte_2600 = false
band_tdd_lte_1900 = false
band_tdd_lte_2300 = false
band_tdd_lte_2500 = false
}
# set(space+?)
at_over_telnet    cellular        ddns            dhcp            dns
event             firewall        IPsec           lan             link_manager
ntp              openvpn        reboot          route           serial_port
sms              snmp           syslog          system          user_management
vrrp
# set cellular(space+?)
  sim    SIM Settings
# set cellular sim(space+?)
  Integer  Index (1..2)

# set cellular sim 1(space+?)
  card          SIM Card
  phone_number  Phone Number
  extra_at_cmd  Extra AT Cmd
  network_type  Network Type
  band_select_type  Band Select Type

```



```

band_gsm_850      GSM 850
band_gsm_900      GSM 900
band_gsm_1800     GSM 1800
band_gsm_1900     GSM 1900
band_wcdma_850    WCDMA 850
band_wcdma_900    WCDMA 900
band_wcdma_1900   WCDMA 1900
band_wcdma_2100   WCDMA 2100
band_lte_800      LTE 800 (band 20)
band_lte_850      LTE 850 (band 5)
band_lte_900      LTE 900 (band 8)
band_lte_1800     LTE 1800 (band 3)
band_lte_1900     LTE 1900 (band 2)
band_lte_2100     LTE 2100 (band 1)
band_lte_2600     LTE 2600 (band 7)
band_lte_1700     LTE 1700 (band 4)
band_lte_700      LTE 700 (band 17)
band_tdd_lte_2600 TDD LTE 2600 (band 38)
band_tdd_lte_1900 TDD LTE 1900 (band 39)
band_tdd_lte_2300 TDD LTE 2300 (band 40)
band_tdd_lte_2500 TDD LTE 2500 (band 41)
# set cellular sim 1 phone_number 18620435279
OK
...
# config save_and_apply
OK // save and apply current configuration, make you configuration effect

```

### 5.3 Commands Reference

Commands	Syntax	Description
Debug	Debug <i>parameters</i>	Turn on or turn off debug function
Show	Show <i>parameters</i>	Show current configuration of each function , if we need to see all please using “show running ”
Set	Set <i>parameters</i>	All the function parameters are set by commands set and add, the difference is that set is for the single parameter and add is for the list parameter
Add	Add <i>parameters</i>	

**Note:** Download the config.XML file from the configured web browser. The command format can refer to the config.XML file format.

# Glossary

Abbreviations	Description
AC	Alternating Current
APN	Access Point Name of GPRS Service Provider Network
APP	Application
ASCII	American Standard Code for Information Interchange
CE	Conformité Européene (European Conformity)
CHAP	Challenge Handshake Authentication Protocol
CLI	Command Line Interface for batch scripting
CSD	Circuit Switched Data
CTS	Clear to Send
dB	Decibel
dBi	Decibel Relative to an Isotropic radiator
DC	Direct Current
DCD	Data Carrier Detect
DCE	Data Communication Equipment (typically modems)
DCS 1800	Digital Cellular System, also referred to as PCN
DI	Digital Input
DO	Digital Output
DSR	Data Set Ready
DTE	Data Terminal Equipment
DTMF	Dual Tone Multi-frequency
DTR	Data Terminal Ready
EDGE	Enhanced Data rates for Global Evolution of GSM and IS-136
EMC	Electromagnetic Compatibility
EMI	Electro-Magnetic Interference
ESD	Electrostatic Discharges
ETSI	European Telecommunications Standards Institute
EVDO	Evolution-Data Optimized
FDD LTE	Frequency Division Duplexing Long Term Evolution
GND	Ground
GPRS	General Packet Radio Service
GRE	generic route encapsulation
GSM	Global System for Mobile Communications
HSPA	High Speed Packet Access
ID	identification data
IMEI	International Mobile Equipment Identification
IP	Internet Protocol
IPsec	Internet Protocol Security

<b>Abbreviations</b>	<b>Description</b>
kbps	kbits per second
L2TP	Layer 2 Tunneling Protocol
LAN	local area network
LED	Light Emitting Diode
M2M	Machine to Machine
MAX	Maximum
Min	Minimum
MO	Mobile Originated
MS	Mobile Station
MT	Mobile Terminated
OpenVPN	Open Virtual Private Network
PAP	Password Authentication Protocol
PC	Personal Computer
PCN	Personal Communications Network, also referred to as DCS 1800
PCS	Personal Communication System, also referred to as GSM 1900
PDU	Protocol Data Unit
PIN	Personal Identity Number
PLCs	Program Logic Control System
PPP	Point-to-point Protocol
PPTP	Point to Point Tunneling Protocol
PSU	Power Supply Unit
PUK	Personal Unblocking Key
R&TTE	Radio and Telecommunication Terminal Equipment
RF	Radio Frequency
RTC	Real Time Clock
RTS	Request to Send
RTU	Remote Terminal Unit
Rx	Receive Direction
SDK	Software Development Kit
SIM	subscriber identification module
SMA antenna	Stubby antenna or Magnet antenna
SMS	Short Message Service
SNMP	Simple Network Management Protocol
TCP/IP	Transmission Control Protocol / Internet Protocol
TE	Terminal Equipment, also referred to as DTE
Tx	Transmit Direction
UART	Universal Asynchronous Receiver-transmitter
UMTS	Universal Mobile Telecommunications System
USB	Universal Serial Bus
USSD	Unstructured Supplementary Service Data

<b>Abbreviations</b>	<b>Description</b>
VDC	Volts Direct current
VLAN	Virtual Local Area Network
VPN	Virtual Private Network
VSWR	Voltage Stationary Wave Ratio
WAN	Wide Area Network
WWAN	Wireless Wide Area Network
WLAN	Wireless local area network

**Guangzhou Robustel Co., Ltd.**

Add: 501, Building 2, No. 63, Yong'an Avenue,  
Huangpu District, Guangzhou, China 510660

Tel: 86-20-82321505

Email: [info@robustel.com](mailto:info@robustel.com)

Web: [www.robustel.com](http://www.robustel.com)