

ANTENNAS | RIPPLE SERIES

X-POLARISED, OMNI-DIRECTIONAL 5G/LTE MULTI MIMO ANTENNA ARRAY

617 – 7200 MHz, 9.5 dBi; Cellular 4x (4x4 MIMO); Wi-Fi 4x4 MIMO; 2 x GPS/GLONASS



- High performance, omni-directional marine & coastal antenna
- Up to 16 x 16 MIMO capability for improved performance
- Covers contemporary 5G/LTE band from 617 to 7200 MHz
- Innovative heat sink design for improved temperature regulation
- UV and saltwater protected for marine and coastal conditions
- IP65 weather/dust resistant enclosure

Product Overview

Poynting Antennas introduces its all-new marine antenna enclosure range, the Ripple antenna enclosure, which adds to our current WaveHunter series. The Ripple antenna enclosure is designed to fit a variety of router and networking modules, transforming the antenna enclosure into a CPE (Customer Premises Equipment) device – just add your own LTE/5G routers. The Ripple enclosure can accommodate routers up to the size of 300 x 250 x 110 mm³, which can be mounted directly onto the base.

The flagship unit will be the RIPL-16 antenna array that consists of 16 cross-polarised, omni-directional antennas arranged in a cross-polarised orientation with 8 x vertically and 8 x horizontally polarised, for improved performance. There is also a RIPL-8 antenna solution, which contains 8 cross-polarised, omni-directional antennas with 4 x vertically and 4 x horizontally polarised. The antennas offer wideband coverage from 617 to 7200 MHz, with a peak gain of 9.5 dBi. Making it ideal for multi-router LTE & 5G bonded and aggregated deployments. The enclosure was designed to withstand adverse weather conditions, making the antenna weatherproof with an IP65 rating. The antenna enclosure was designed specifically for marine & coastal applications.

Features

- Ultra-wideband coverage from 617 to 7200 MHz
- High performance antennas with a peak gain of 9.5 dBi
- Up to 16 x 16 MIMO for improved performance
- Purpose built antenna for marine and coastal applications
- Weatherproof and water-resistant enclosure (IP65)

Application Areas

- Marine applications: Super yachts, commercial vessels, cruise ships, ferries, private yachts, and towing vessels
- Harsh environments such as harbour buildings, and buoys
- Enhanced LTE/4G and 5G reception
- Increase system transmission reliability

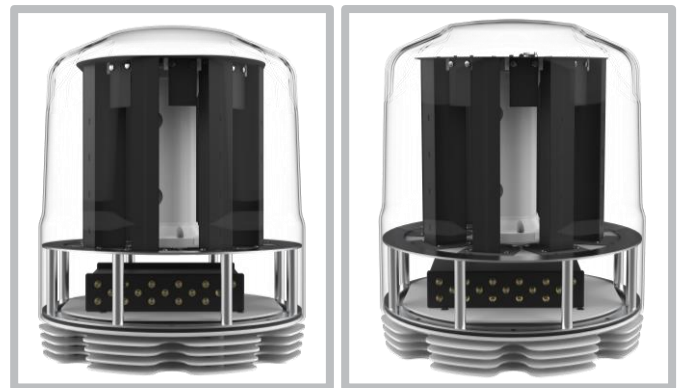

Frequency Bands

The RIPPLE is a circular array of omni-directional antennas that operate in the following frequency bands: | 617 – 960 MHz | 1427 – 1517 MHz | 1710 – 2700 MHz | 3400 – 4200 MHz | 5000 – 7200 MHz | and the following Wi-Fi frequency bands | 2400 – 2500 MHz | and | 5000 – 7200 MHz |

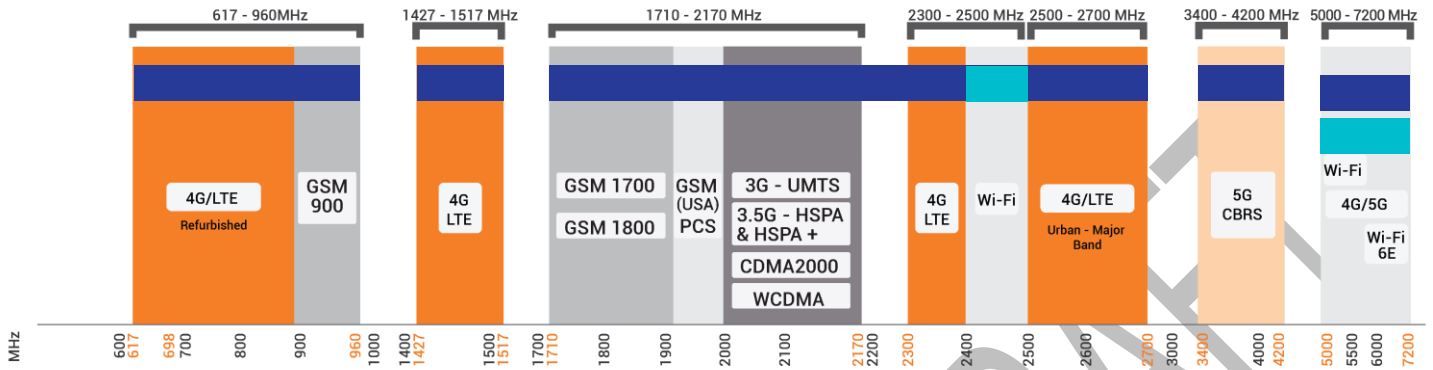

Indicates the 5G/LTE bands on which RIPPLE works Indicates the WI-FI bands on which RIPPLE works

Antenna Derivatives

Product Order Code (SKU)	A-RIPL-0008-V1-01	A-RIPL-0016-V1-01
Ports	LTE- Vertical Polarised (x 4), LTE- Horizontal Polarised (x 4) Wi-Fi- Vertical Polarised (x 2), Wi-Fi- Horizontal Polarised (x 2) GPS (x 2)	LTE- Vertical Polarised (x 8), LTE- Horizontal Polarised (x 8) Wi-Fi- Vertical Polarised (x 2), Wi-Fi- Horizontal Polarised (x 2)
SISO / MIMO	2x2 or 4x4 MIMO- LTE 4x4 MIMO – Wi-Fi	2x2 or 4x4 MIMO- LTE 4x4 MIMO – Wi-Fi
Frequency Bands	617 - 7200 MHz	617 - 7200 MHz
Polarisation	Vertical & Horizontal	Vertical & Horizontal
Peak Gain	9.5 dBi	9.5 dBi
Connector Type	14 x SMA (F)	22 x SMA (F)
Coax Cable Type	10 x RG 316 (RA-SMA-M to RA-SMA-M): LTE & GPS 4 x RG 316 (RA-RPSMA-M to RA-SMA-M): Wi-Fi	18 x RG 316 (RA-SMA-M to RA-SMA-M): LTE & GPS 4 x RG 316 (RA-RPSMA-M to RA-SMA-M): Wi-Fi
Coax Cable Length	350 mm - LTE, Wi-Fi & GPS	350 mm - LTE, Wi-Fi & GPS
Weight	TBD	15.44 kg
Packaged Weight	TBD	23.64 kg
EAN	6009710927175	6009710927199

*RA SMA: Right Angle/90° SMA

*RA RPSMA: Right Angle/90° Reverse Polarity SMA

*The coax cables & connectors are factory mounted to the antenna

Electrical Specifications - Cellular

Frequency bands:	617 – 960 MHz 1427 – 1517 MHz 1710 – 2700 MHz 3400 – 4200 MHz 5000 – 7200 MHz
Gain Vertical:	5.5 dBi @ 617 – 960 MHz 5 dBi @ 1427 – 1517 MHz 6 dBi @ 1710 – 2700 MHz 9.5 dBi @ 3400 – 4200 MHz 9 dBi @ 5000 – 7200 MHz
Gain Horizontal:	1 dBi @ 617 – 960 MHz 0 dBi @ 1427 – 1517 MHz 3 dBi @ 1710 – 2700 MHz 1 dBi @ 3400 – 4200 MHz 1 dBi @ 5000 – 7200 MHz
VSWR Vertical:	≤2.5:1 across 90% of the bands
VSWR Horizontal:	≤2.5:1
Feed Power Handling:	10 W
Input Impedance:	50 Ohm (nominal)
DC Short:	Yes

Electrical Specifications - GPS/Glonass

Frequency Range (GPS):	1575.42MHz/1600MHz
Gain (Max):	21+/-2dBi
VSWR:	≤1.5:1
DC Voltage:	2.7-3.3 V
DC Current:	5-15mA
Noise Figure:	≤1.5 dB
Nominal Impedance:	50 Ω
Polarisation:	RHCP
Filter Out Band Attenuation:	12dB Min f0+50MHz, 16dBi Min f0-50MHz
Max. Power:	50 W
Coax Cable Loss:	0.71 dB/m @ 1500 MHz

Electrical Specifications - Wi-Fi

Frequency:	2400 - 2500 MHz 5000 – 7200 MHz
Gain (Max):	5 dBi @ 2400 - 2500 MHz 8.5 dBi @ 5000 - 7200 MHz
VSWR:	≤ 2:1 over 95% of the band
Feed Power Handling:	10 W
Nominal Input Impedance:	50 Ohm (nominal)

Coax Cable Loss:	0.91 dB/m @ 2400 MHz 1.65 dB/m @ 5800 MHz
Path to Ground:	Yes

Product Box Contents

Antenna:	A-RIPL-V1-01
Mounting Bracket:	N/A

Mechanical Specifications

Product Dimensions	496 mm x Ø410 mm
Packaged Dimensions:	546mm x 460mm
Radome Material:	UV Stable E-Glass
Radome Colour:	Brilliant White Pantone P 179-1 C
Mounting Type:	Surface mount

Environmental Specifications, Certification & Approvals

Wind Survival:	≤186 km/h
Temperature Range (Operating):	-40°C to +80°C
Environmental Conditions:	Outdoor/Indoor
Water ingress protection ratio/standard:	IP 65
Salt Spray:	MIL-STD 810G/ASTM B117
Operating Relative Humidity:	Up to 98%
Storage Humidity:	5% to 95% - non-condensing
Storage Temperature:	-40°C to +80°C
Enclosure Flammability Rating:	UL 94-HB
Impact resistance:	IK 08
Product Safety & Environmental:	Complies with CE and RoHS standards



Antenna Performance Plots

VSWR: Cellular Vertical

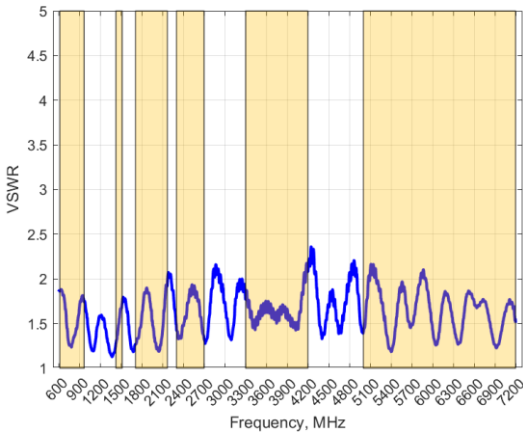

Voltage Standing Wave Ratio (VSWR)*

VSWR is a measure of how efficiently radio-frequency power is transmitted from a power source, through a transmission line, into a load. In an ideal system, 100% of the energy is transmitted which corresponds to a VSWR of 1:1.

The RIPL delivers superior performance across all bands with a VSWR of 2.5:1 or better across 90% of the bands.

*VSWR measured with a 2m low loss cable.

GAIN (EXCLUDING CABLE LOSS): Cellular Vertical

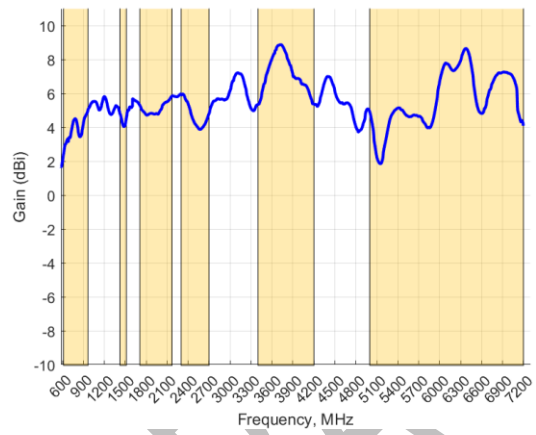

Gain* in dBi

9.5 dBi is the peak gain across all bands from 617 – 7200 MHz

Gain @ 617 – 960 MHz:	5.5 dBi
Gain @ 1427 – 1517 MHz:	5 dBi
Gain @ 1710 – 2700 MHz:	6 dBi
Gain @ 3400 – 4200 MHz:	9.5 dBi
Gain @ 5000 – 7200 MHz:	9 dBi

*Antenna gain measured with polarisation aligned standard antenna

VSWR: Cellular Horizontal

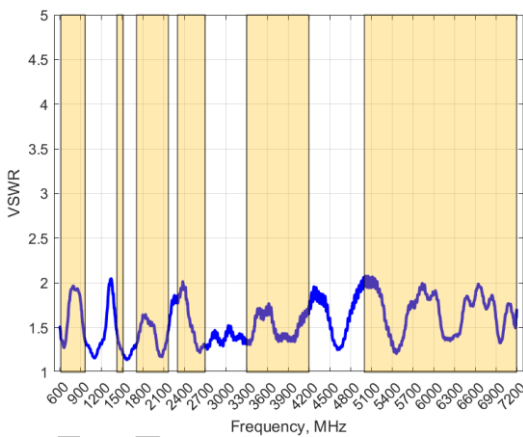

Voltage Standing Wave Ratio (VSWR)*

VSWR is a measure of how efficiently radio-frequency power is transmitted from a power source, through a transmission line, into a load. In an ideal system, 100% of the energy is transmitted which corresponds to a VSWR of 1:1.

The RIPL-16 delivers superior performance across all bands with a VSWR of 2.5:1 or better.

*VSWR measured with a 2m low loss cable.

GAIN (EXCLUDING CABLE LOSS): Cellular Horizontal

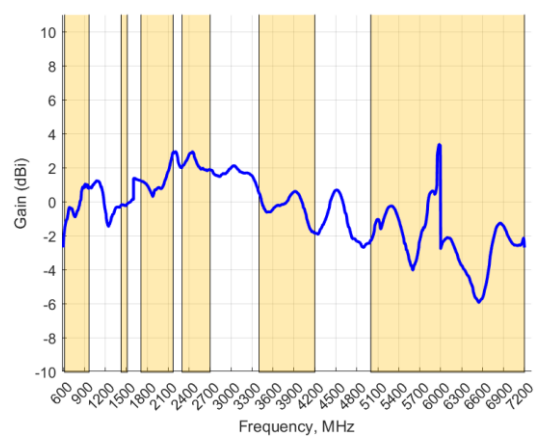

Gain* in dBi

3 dBi is the peak gain across all bands from 617 – 7200 MHz

Gain @ 617 – 960 MHz:	1 dBi
Gain @ 1427 – 1517 MHz:	0 dBi
Gain @ 1710 – 2700 MHz:	3 dBi
Gain @ 3400 – 4200 MHz:	1 dBi
Gain @ 5000 – 7200 MHz:	1 dBi

*Antenna gain measured with polarisation aligned standard antenna

VSWR: WI-FI

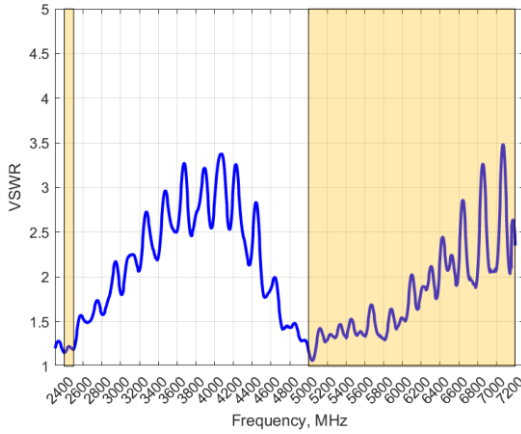

Voltage Standing Wave Ratio (VSWR)*

VSWR is a measure of how efficiently radio-frequency power is transmitted from a power source, through a transmission line, into a load. In an ideal system, 100% of the energy is transmitted which corresponds to a VSWR of 1:1.

The RIPL delivers superior performance across all bands with a VSWR of 2.5:1 or better.

*VSWR measured with a 2m low loss cable.

GAIN (EXCLUDING CABLE LOSS): WI-FI

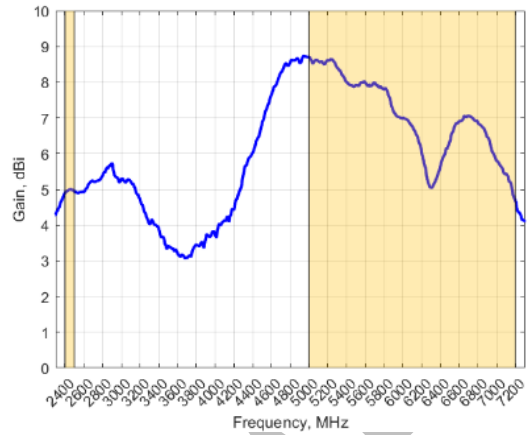

Gain* in dBi

8.5 dBi is the peak gain across all bands from 2400 – 7200 MHz

Gain @ 2400 – 2500 MHz:

5 dBi

Gain @ 5000 – 7200 MHz:

8.5 dBi

*Antenna gain measured with polarisation aligned standard antenna

Technical Drawings

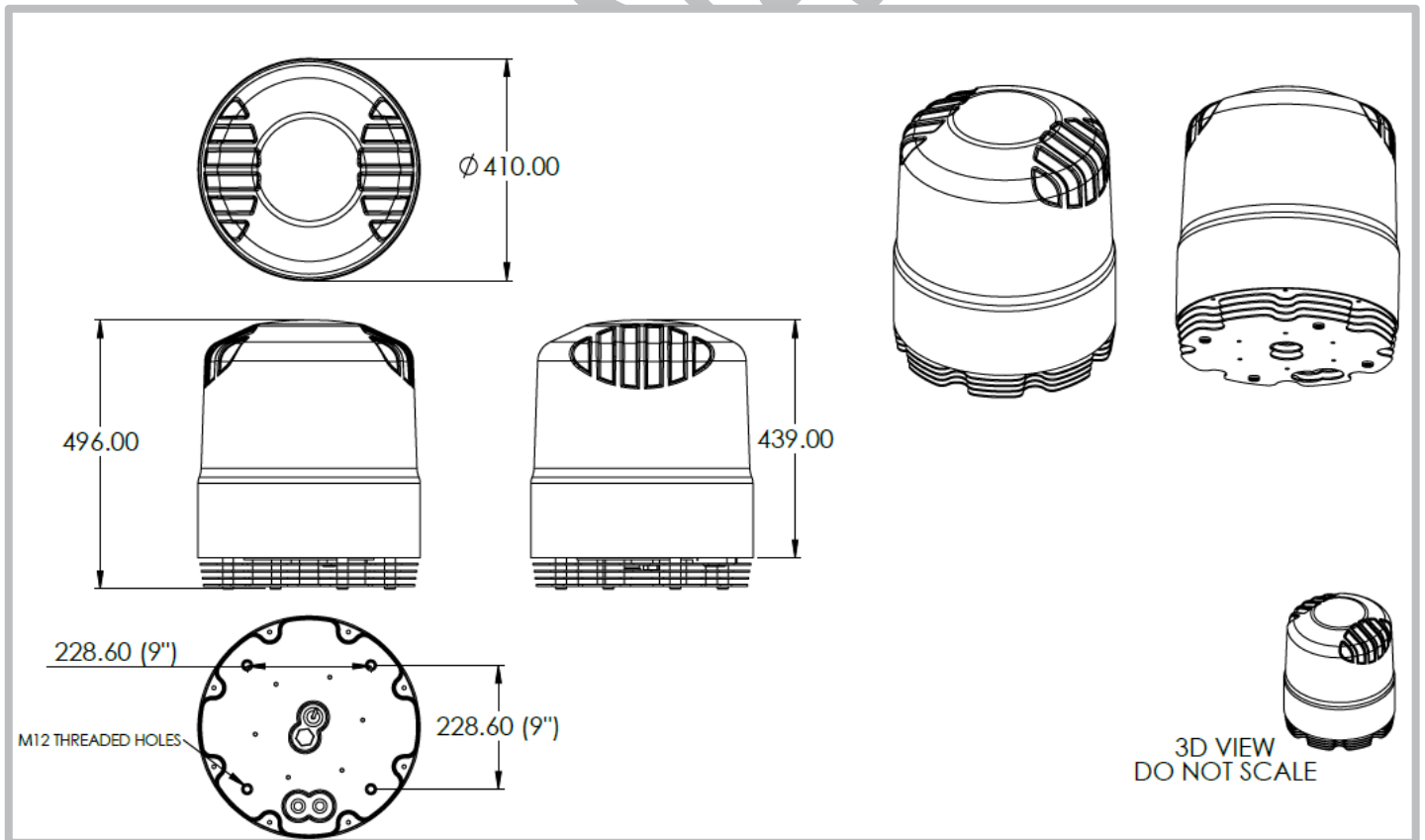

Radiation Patterns - Cellular Vertical

Azimuth: 617 – 968 MHz

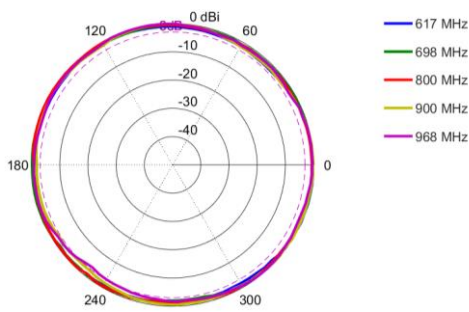

Azimuth: 1427 – 1517 MHz

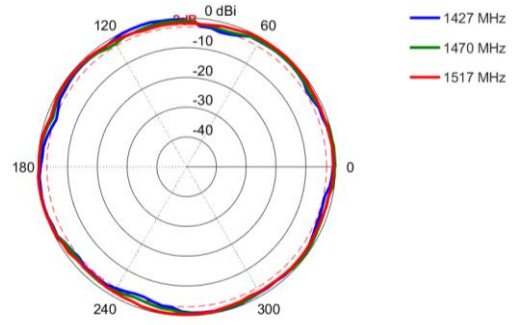

Azimuth: 1710 – 2700 MHz

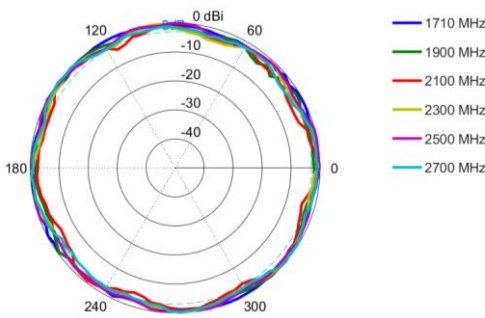

Azimuth: 3400 – 4200 MHz

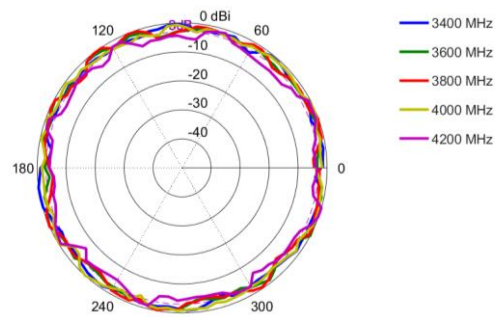

Azimuth: 5000 – 6000 MHz

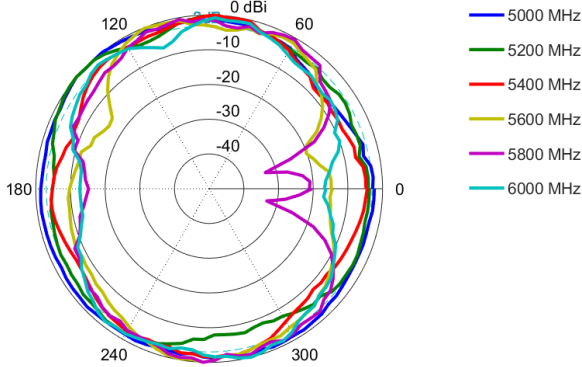

Azimuth: 6000 – 7200 MHz

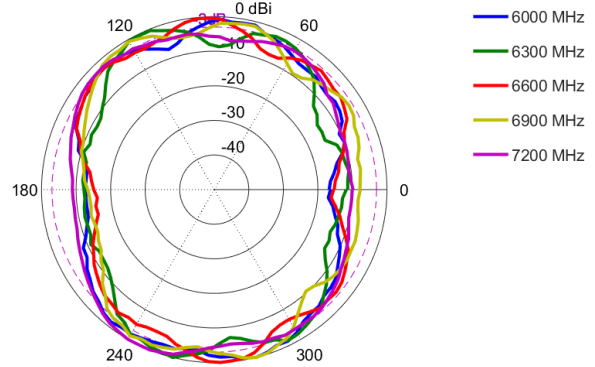

Elevation: 617 – 968 MHz

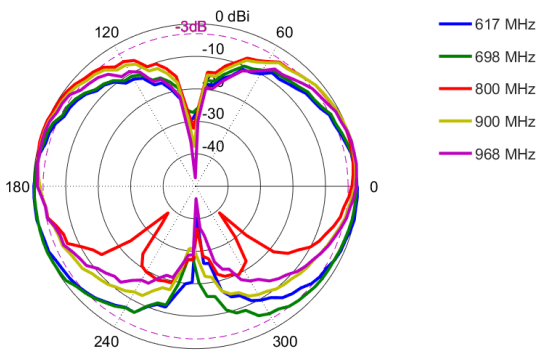

Elevation: 1427 – 1517 MHz

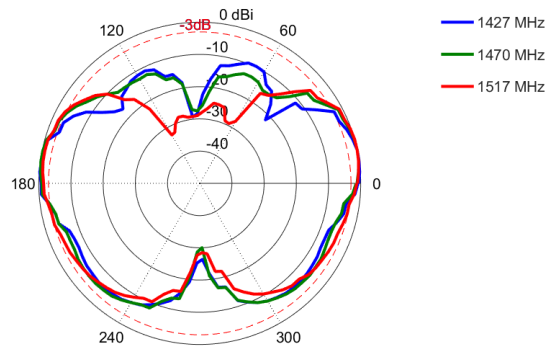

Elevation: 1710 – 2700 MHz

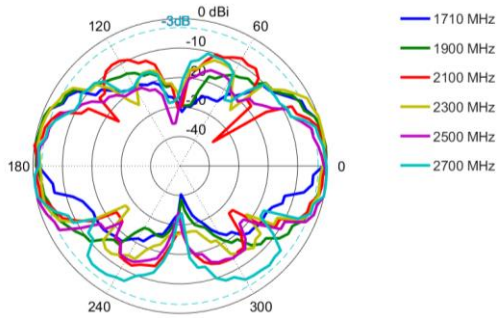

Elevation: 3400 – 4200 MHz

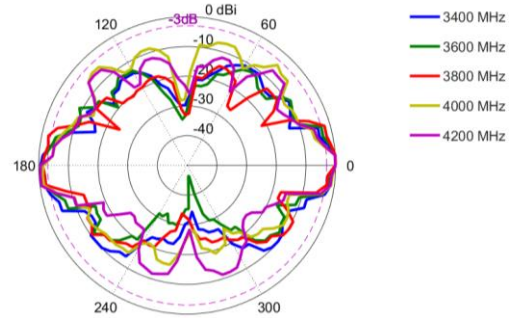

Elevation: 5000 – 6000 MHz

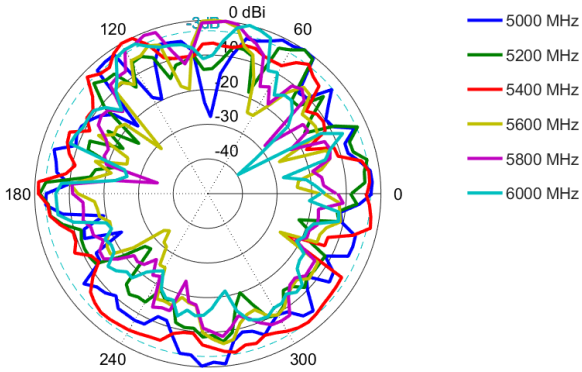

Elevation: 6000 – 7200 MHz

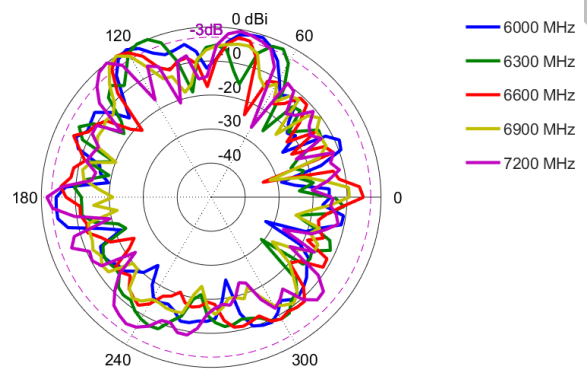

Radiation Patterns - Cellular Horizontal

Azimuth: 617 – 968 MHz

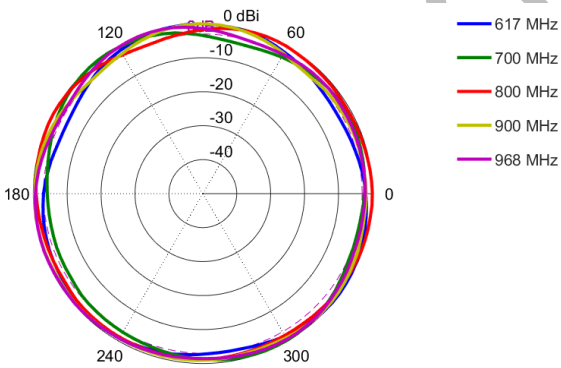

Azimuth: 1427 – 1517 MHz

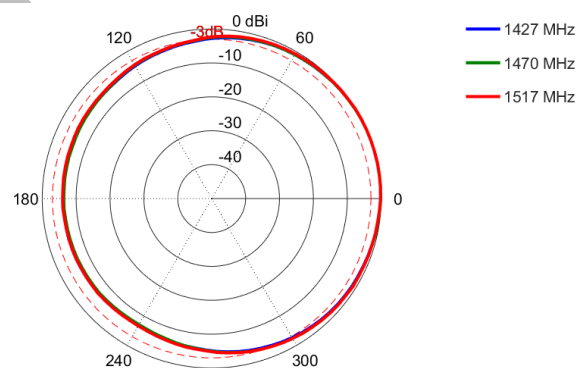

Azimuth: 1710 – 2700 MHz

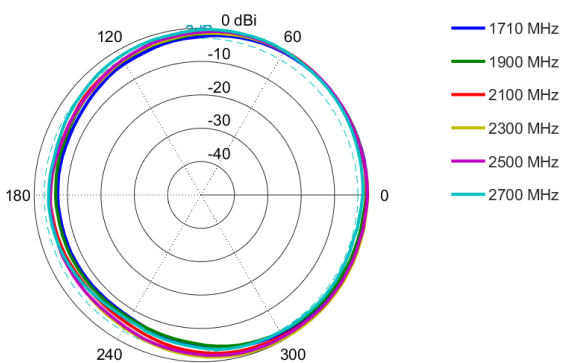

Azimuth: 3400 – 4200 MHz

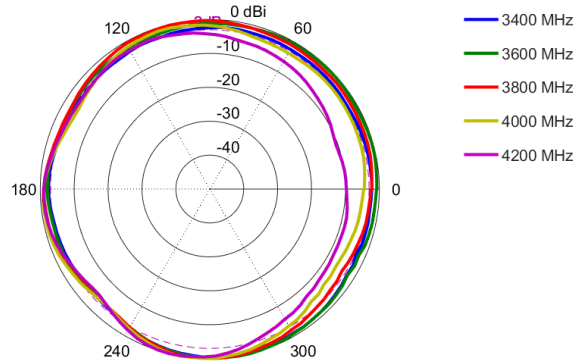

Azimuth: 5000 – 6000 MHz

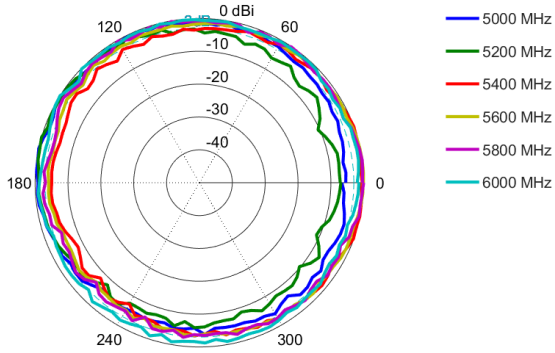

Azimuth: 6000 – 7200 MHz

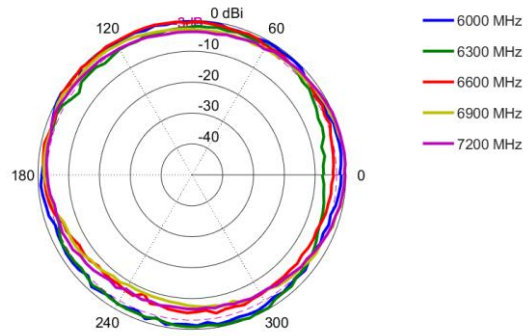

Elevation: 617 – 968 MHz

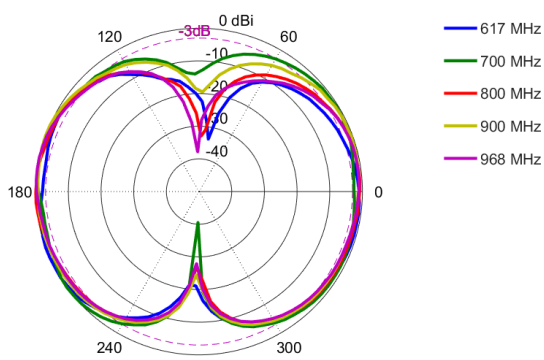

Elevation: 1427 – 1517 MHz

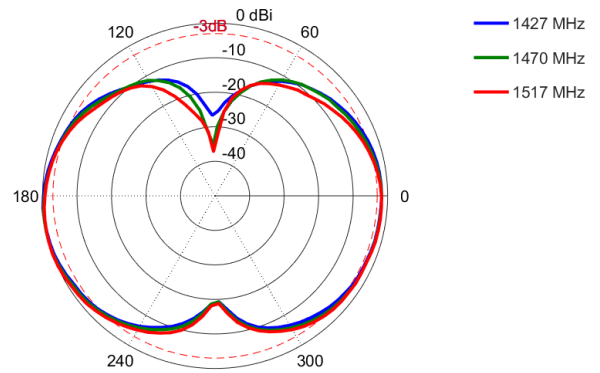

Elevation: 1710 – 2700 MHz

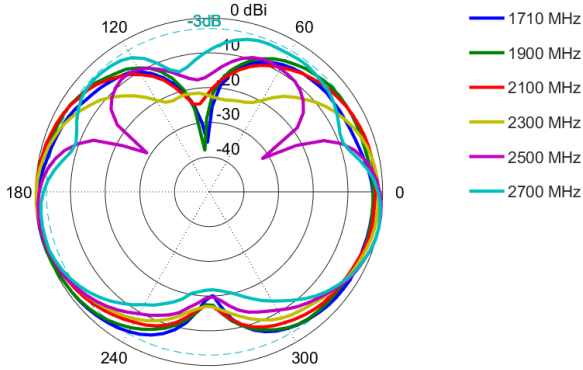

Elevation: 3400 – 4200 MHz

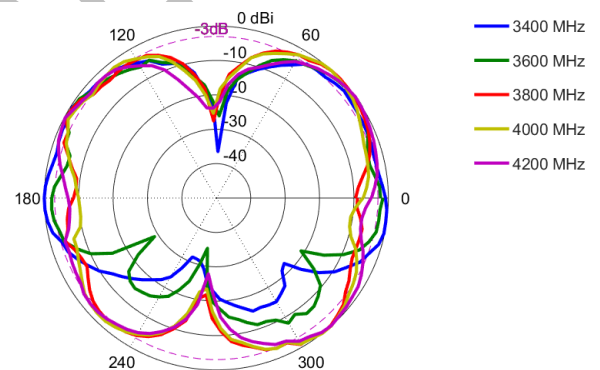

Elevation: 5000 – 6000 MHz

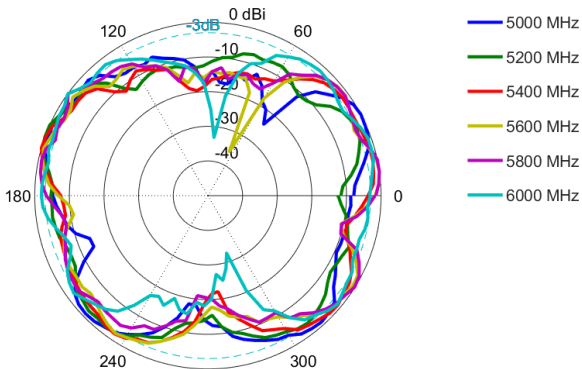

Elevation: 6000 – 7200 MHz

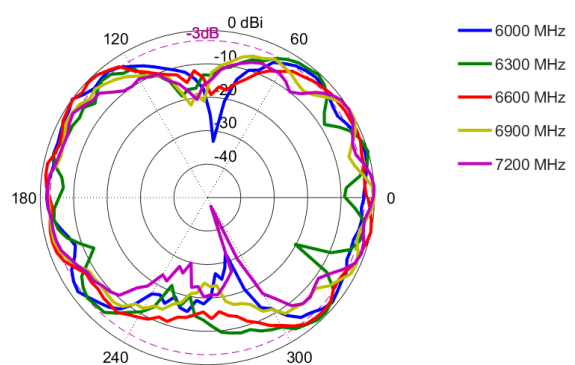

Radiation Patterns - WI-FI

Azimuth: 2400 - 2500 MHz

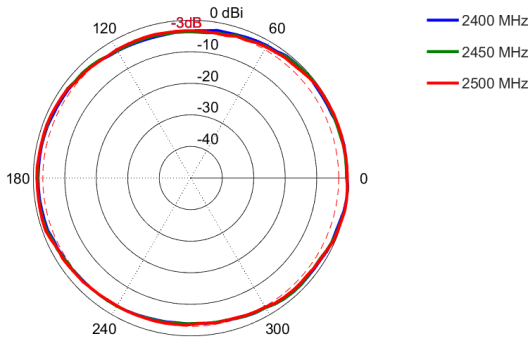

Azimuth: 5000 - 6000 MHz

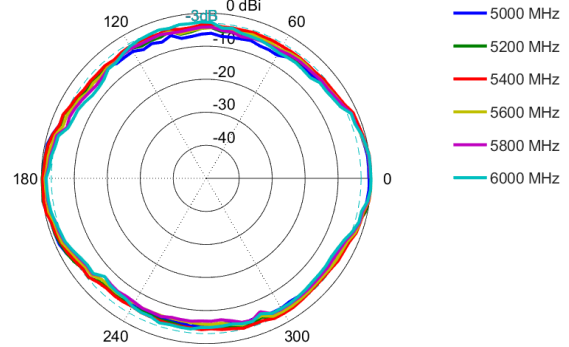

Azimuth: 6000 - 7200 MHz

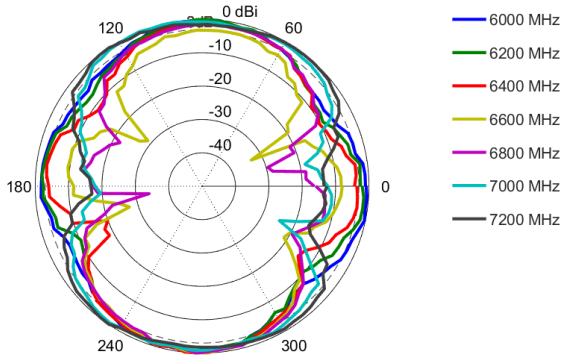

Elevation: 2400 - 2500 MHz

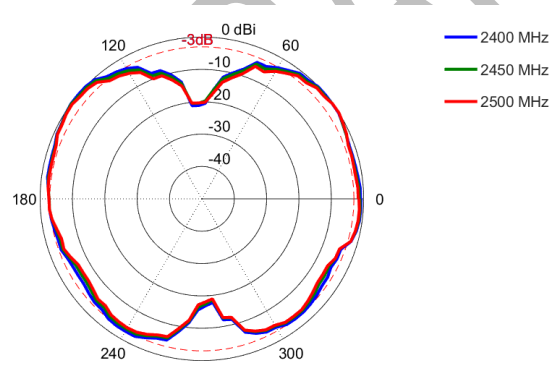

Elevation: 5000 - 6000 MHz

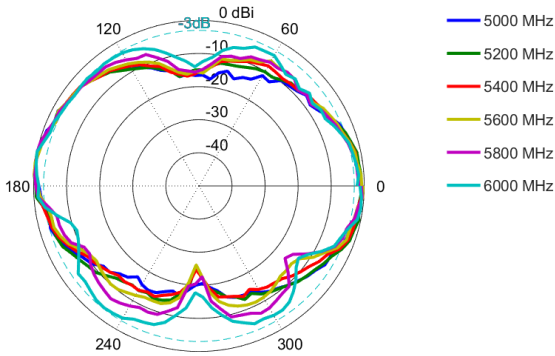

Elevation: 6000 - 7200 MHz

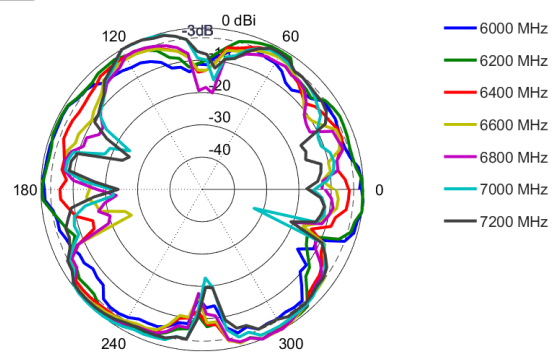

Mounting Options

Surface Mount



PROVISIONAL DRAFT

Additional Accessories

See accessories technical specifications on www.poynting.tech

CONTACT POYNTING

Poynting Antennas (Pty) Ltd - Head Office

Unit 4, N1 Industrial Park,
Landmarks Avenue,
Samrand, 0157, South Africa

Phone: +27 (0) 12 657 0050

E-mail: info@poynting.tech

International Email: sales-global@poynting.tech

Poynting Europe

Regus Business Center Neue Messe Riem
Kronstadter Straße 4
81677 München
Germany

Phone: +49 89 7453 9002

E-mail: sales-europe@poynting.tech

Poynting USA

1804 Owen Court, Suite 104,
Mansfield,
TX 76063
USA

Phone: +1 817 533-8130

E-mail: sales-us@poynting.tech