

ANTENNAS | MIMO-3-17 SERIES

7-IN-1 TRANSPORTATION & AUTOMOTIVE ANTENNA

410 – 3800 MHz; 4x4 LTE (MIMO), 6.2 dBi; 2x2 Wi-Fi (MIMO), 7 dBi; GPS/GLONASS, 21 dBi

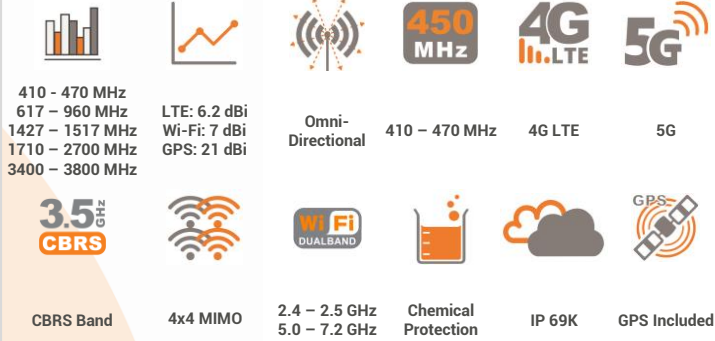

APPLICATION AREAS

- 7-in-1 High performance multi frequency 2G/3G/4G/LTE/5G antenna
- 4x4 MIMO LTE, 2x2 MIMO Wi-Fi & GPS / GLONASS
- Ultra-wideband, includes 450 MHz and 3.5 GHz CBRS bands
- Robust and water-resistant antenna (IP69K)
- Ideal for transportation and marine use
- Multi mounting options for easy installation

Product Overview

The MIMO-3-17 is a 7-in-1 high performance multi frequency antenna within a single housing, providing four cellular, two Wi-Fi and a GPS/GLONASS antenna. The four cellular MIMO antennas (for 2G/3G/4G) covers the contemporary 617 MHz to 2700 MHz bands, as well as the new emerging LTE and 5G spectrum for 450MHz and 3.5GHz CBRS bands, which is becoming popular across the various international cellular network operators for LTE. The ultra-wideband performance of the antenna allows it to be used across different operators and technologies and is ready for future cellular technologies up to 3.8 GHz for 5G applications. The antenna also provides two separate dual-band Wi-Fi antennas, providing concurrent 2.4 GHz and 5 GHz on each antenna with 2x2 MIMO capability. The seventh antenna is a high-performance active GPS/GLONASS system operating down to -40°C.

The MIMO-3-17 exceeds the performance of most competitors due to the attention to the design of this high-performance antenna. The radiation patterns of all radiating elements provide an excellent balance between omnidirectionality, pattern diversity and good radiation abilities at the desired elevation. This is an important criterion for the transportation and marine market. which the antenna was specifically designed for. Main applications are for commercial/industrial vehicles, marine, M2M and other IoT systems using a wide range of radio technologies, while remaining futureproof over the wide frequency band.

Features

- Ultra-wideband from 410 to 470 MHz, 617 to 2700 MHz and 3400 to 3800 MHz bands
- Cleverly designed decorrelated antennas give superior MIMO performance in both Wi-Fi bands and cellular bands
- Includes high-performance GPS/GLONASS antenna
- Careful mechanical design provides ruggedness, corrosion, water and dust resistance (IP69K)
- Ground plane independent: MIMO-3 is designed with an internal ground plane, making the antenna suitable for implementation on all surface types

Application Areas

- Transport broadband and Wi-Fi distribution, automation and telemetry for buses, utility, trucks and public safety vehicles
- Industrial factory automation, robotic machinery and other M2M systems telemetry
- Farming & agricultural automation such as M2M & IoT
- Broadband cellular to Wi-Fi distribution for marine / boats (inland and near coastal vessels)
- Mining vehicles and machinery communications, telemetry and automation (M2M & IoT)



Frequency Bands

The MIMO-3-17 is an Omni-directional antenna that works from | 410 - 470 MHz | 617 - 960 MHz | 1427 - 1517 MHz | 1710 - 2700 MHz | 3400 - 3800 MHz | and the following Wi-Fi frequency bands | 2400 - 2500 MHz | and | 5000 - 7200 MHz |

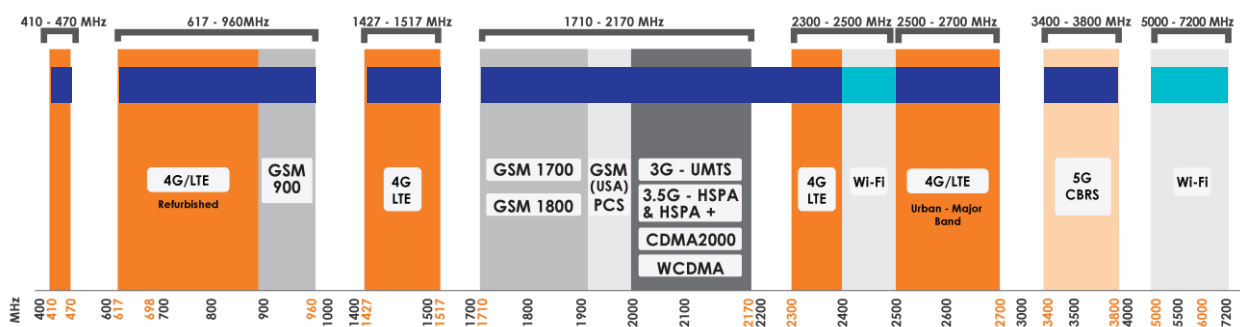

Indicates the LTE bands on which MIMO-3-17 works

Indicates the WI-FI bands on which MIMO-3-17 works

Antenna Derivatives

Product Order Code (SKU)	A-MIMO-0003-V2-17	A-MIMO-0003-V2-17-B
Radome Colour	White	Black
Ports	1 - 4 - LTE, 5 & 6 - Wi-Fi 7 - GPS	1 - 4 - LTE, 5 & 6 - Wi-Fi 7 - GPS
SISO / MIMO	4x4 MIMO - LTE 2x2 MIMO - Wi-Fi	4x4 MIMO - LTE 2x2 MIMO - Wi-Fi
Coax Cable Type	RTK-031 - LTE, Wi-Fi & GPS	RTK-031 - LTE, Wi-Fi & GPS
Coax Cable Length	2m - LTE, Wi-Fi & GPS	2m - LTE, Wi-Fi & GPS
Connector Type	SMA (M) - LTE, Wi-Fi & GPS	SMA (M) - LTE, Wi-Fi & GPS
EAN	6009710920848	6009710922125
EU Homologation Number	E1*10R06/01*9550*00	E1*10R06/01*9550*00

*The coax cable & connector are factory mounted to the antenna

MIMO-3-17

©2022 Poynting Antennas (Pty) Ltd. All rights reserved
Product Specifications may change without prior notice
Revised: June 2022

Electrical Specifications - Cellular

Frequency Bands:	410 - 470 MHz 617 - 960 MHz 1427 - 1517 MHz 1710 - 2700 MHz 3400 - 3800 MHz
Gain (max):	1.5 dBi @ 410 - 470 MHz 2.2 dBi @ 617 - 960 MHz 4.2 dBi @ 1427 - 1517 MHz 6.2 dBi @ 1710 - 2700 MHz 4.8 dBi @ 3400 - 3800 MHz
VSWR:	≤2.5:1 across 90% of the bands
Feed Power Handling:	10 W
Input Impedance:	50 Ohm (nominal)
Polarisation:	Linear Vertical
Coax Cable Loss:	0.350 dB/m @ 400 MHz 0.560 dB/m @ 900 MHz 0.71 dB/m @ 1500 MHz 0.785 dB/m @ 1800 MHz 1.20 dB/m @ 3000 MHz
DC short:	Yes

GPS/Glonass Antenna Electrical Specifications

Frequency Range (GPS):	1575.42MHz/1600MHz
Gain (Max):	21+/-2dBi
VSWR:	≤1.5:1
DC Voltage:	2.7-3.3 V
DC Current:	5-15mA
Noise Figure:	≤1.5 dB
Nominal Impedance:	50 Ω
Polarisation:	RHCP
Filter Out Band Attenuation:	12dB Min f0+50MHz, 16dBi Min f0-50MHz
Voltage:	2.7 - 3.3V
Max. Power:	50 W
Coax Cable Loss:	0.71 dB/m @ 1500 MHz

Wi-Fi Electrical Specifications

Frequency:	2400 - 2500 MHz 5000 - 7200 MHz
Gain (Max):	3 dBi @ 2400 - 2500 MHz 7 dBi @ 5000 - 7200 MHz
VSWR:	≤ 2.5:1 over 95% of the band
Feed Power Handling:	10 W
Nominal Input Impedance:	50 Ohm (nominal)
Coax Cable Loss:	0.91 dB/m @ 2400 MHz 1.65 dB/m @ 5800 MHz
Path to Ground:	Yes

Product Box Contents

Antenna:	A-MIMO-0003-V2-17 or A-MIMO-0003-V2-17-B
Mounting Bracket:	Threaded spigots (up to 60mm clamping thickness), adhesive surface mounting & optional magnetic mount
Adapters:	RPSMA(M) to SMA (F)

Mechanical Specifications

Product Dimensions:	253 mm x 128 mm x 144 mm
Packaged Dimensions:	265 mm x 211 mm x 204 mm
Weight:	1.51 kg
Packaged Weight:	1.61 kg
Radome Material:	UV Stable ASA
Mounting Type:	Spigot, Surface and Magnetic mount options

Environmental Specifications, Certification & Approvals

Wind Survival:	≤220 km/h
Temperature Range (Operating):	-40°C to +80°C
Environmental Conditions:	Outdoor/Indoor
Water Ingress Protection Ratio/Standard:	IP69K
Salt Spray:	MIL-STD 810G/ASTM B117
Operating Relative Humidity:	Up to 98%
Storage Humidity:	5% to 95% - non-condensing
Storage Temperature:	-40°C to +80°C
Enclosure Flammability Rating:	UL 94-HB
Impact Resistance:	IK 10
Product Safety & Environmental:	Complies with CE and RoHS standards



Antenna Performance Plots

VSWR: Cellular Antenna

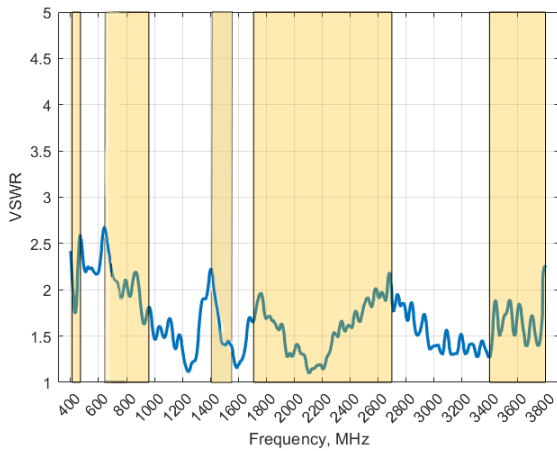

Voltage Standing Wave Ratio (VSWR)*

VSWR is a measure of how efficiently radio-frequency power is transmitted from a power source, through a transmission line, into a load. In an ideal system, 100% of the energy is transmitted which corresponds to a VSWR of 1:1.

The MIMO-3-17 delivers superior performance across all bands with a VSWR of $\leq 2.5:1$ across 90% of the band.

**VSWR measured with a 2m low loss cable, 650 x 650 mm ground plane and unused ports terminated with 50Ω load.*

GAIN (EXCLUDING CABLE LOSS): Cellular Antenna

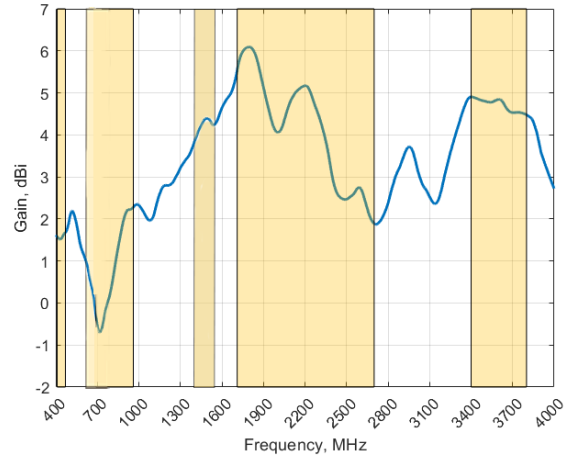

Gain* in dBi

6.2 dBi is the peak gain across all bands from 410 – 3800 MHz

Gain @ 410 - 470 MHz:	1.5 dBi
Gain @ 617 - 960 MHz:	2.2 dBi
Gain @ 1427 - 1517 MHz:	4.2 dBi
Gain @ 1710 - 2700 MHz:	6.2 dBi
Gain @ 3400 - 3800 MHz:	4.8 dBi

**Antenna gain measured with a 650 x 650 mm ground plane and polarisation aligned standard antenna*

VSWR: Wi-Fi Antenna

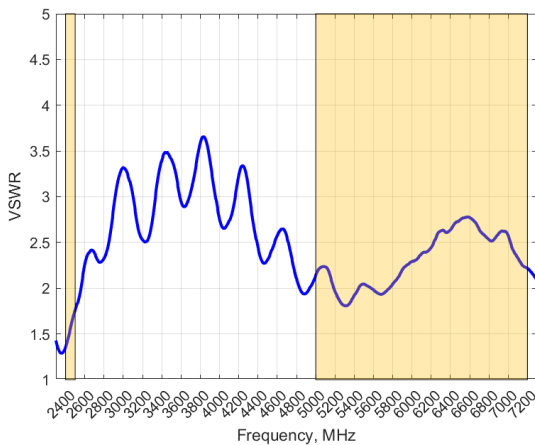

Voltage Standing Wave Ratio (VSWR)*

VSWR is a measure of how efficiently radio-frequency power is transmitted from a power source, through a transmission line, into a load. In an ideal system, 100% of the energy is transmitted which corresponds to a VSWR of 1:1.

The MIMO-3-17 delivers superior performance across all bands with a VSWR of $\leq 2.5:1$ across 90% of the band.

**VSWR measured with a 2m low loss cable, 650 x 650 mm ground plane and unused ports terminated with 50Ω load.*

GAIN (EXCLUDING CABLE LOSS): Wi-Fi Antenna

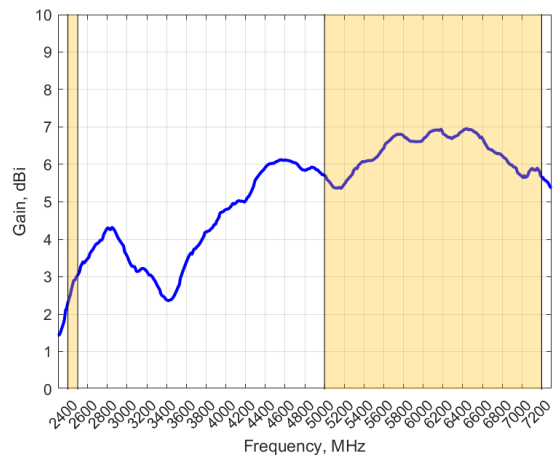

Gain* in dBi

7 dBi is the peak gain across all bands from 2400 – 2500 MHz and 5000 – 7200 MHz

Gain @ 2400 - 2500 MHz:	3 dBi
Gain @ 5000 - 7200 MHz:	7 dBi

**Antenna gain measured with a 650 x 650 mm ground plane and polarisation aligned standard antenna*

Technical Drawings

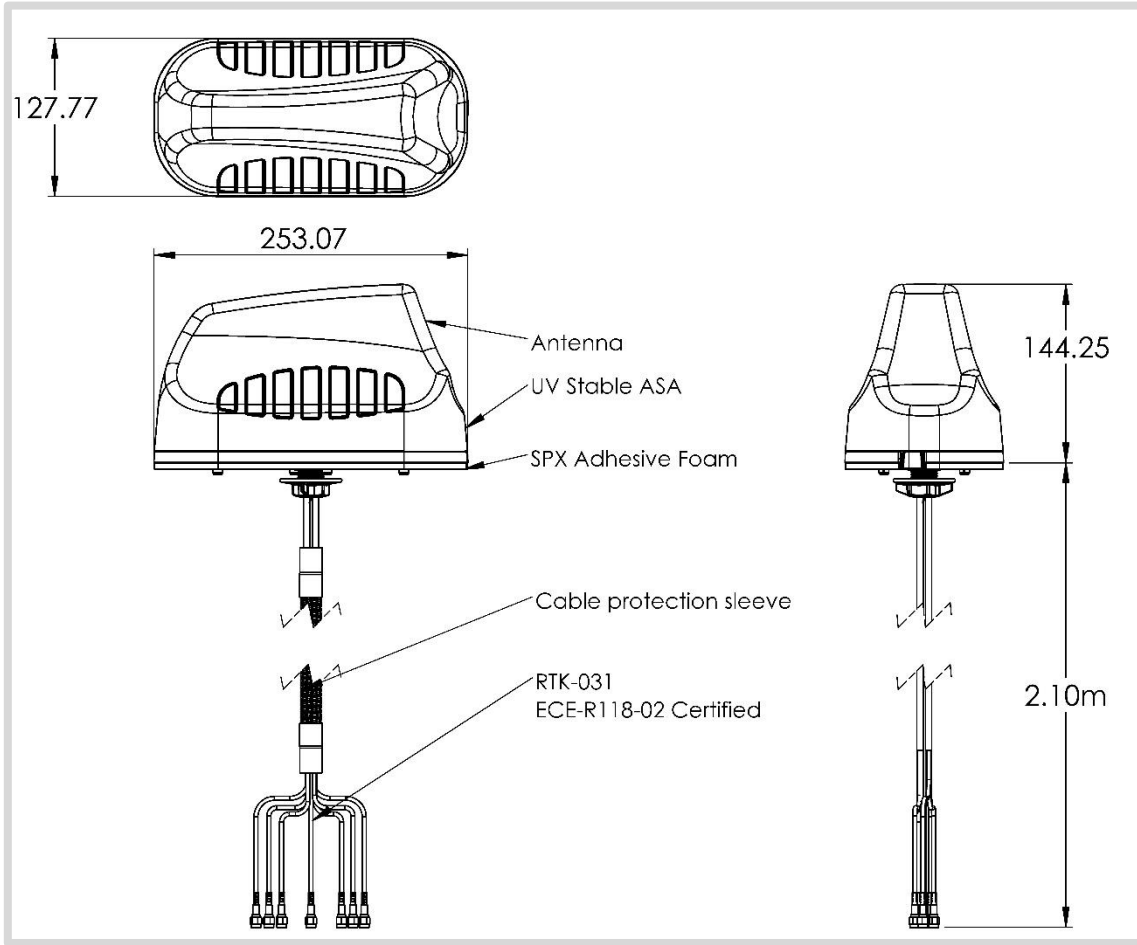

Radiation Patterns – Cellular

Azimuth (Top View): 410–470 MHz

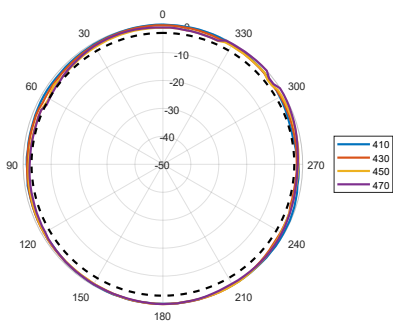

Azimuth (Top View): 698–960 MHz

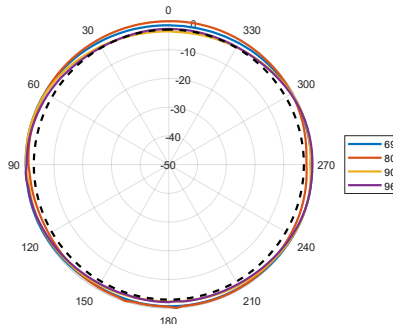

Azimuth (Top View): 1710–2100 MHz

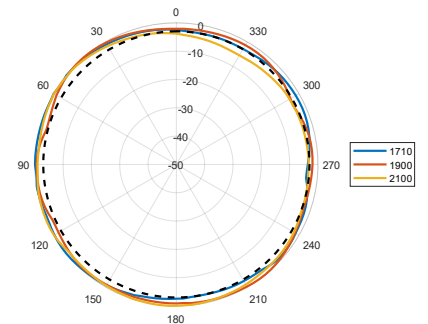

Azimuth (Top View): 2300–2700 MHz

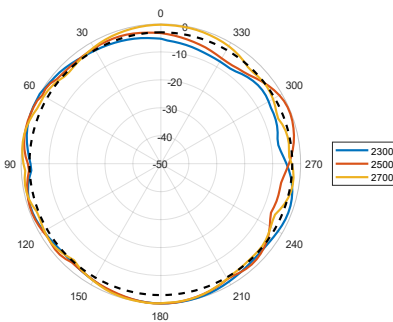

Azimuth (Top View): 3400–3800 MHz

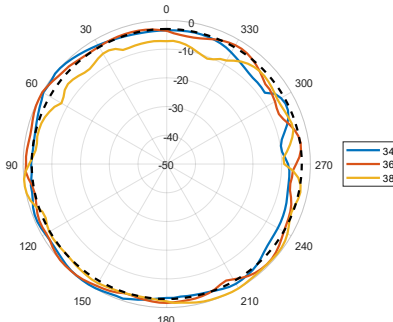

Elevation1 (Side View): 410–470 MHz

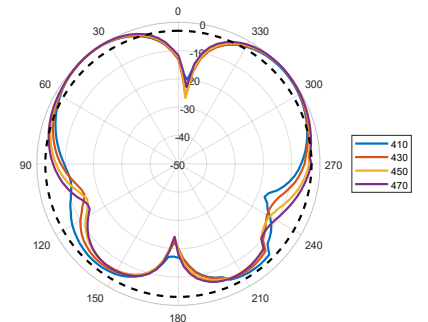

Elevation1 (Side View): 698-960 MHz

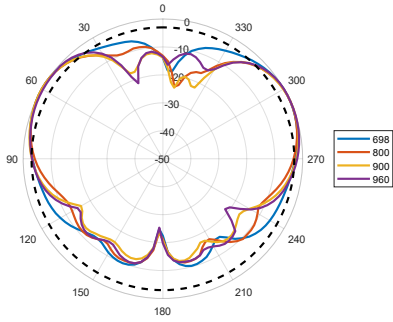

Elevation1 (Side View): 1710-2100 MHz

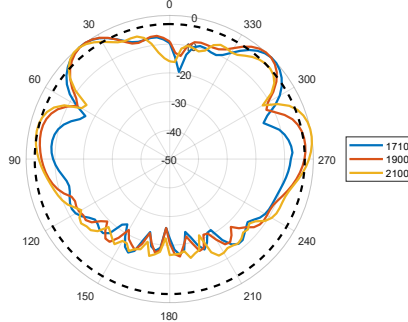

Elevation1 (Side View): 2300-2700 MHz

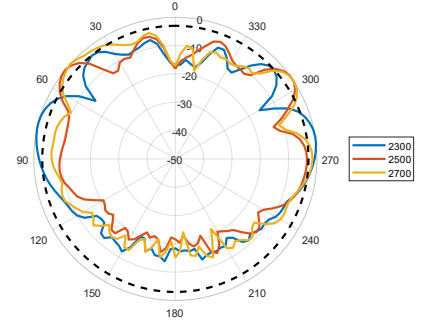

Elevation1 (Side View): 3400-3800 MHz

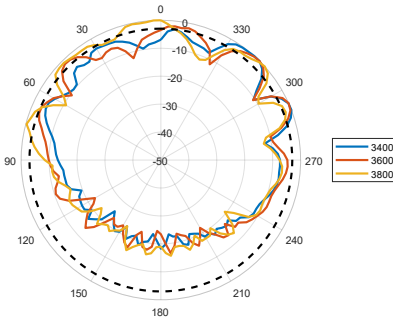

Elevation2 (Side View): 410-470 MHz

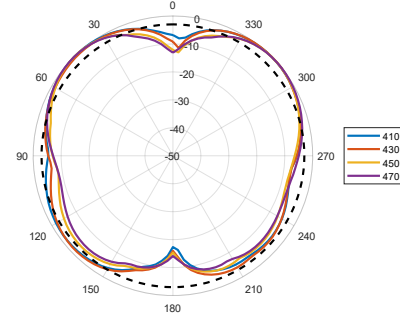

Elevation2 (Side View): 698-960 MHz

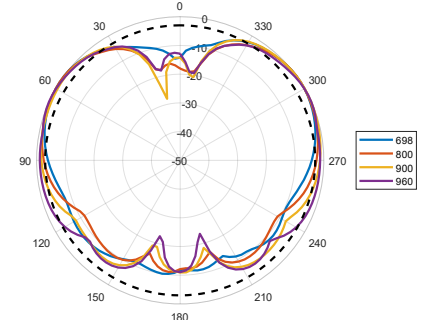

Elevation2 (Side View): 1710-2100 MHz

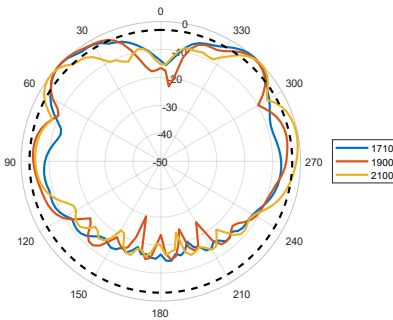

Elevation2 (Side View): 2300-2700 MHz

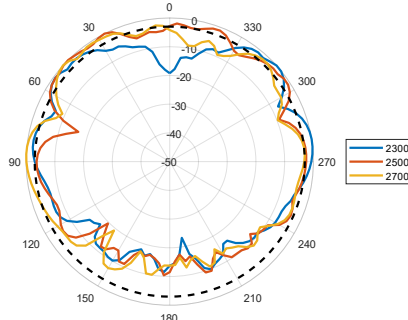

Elevation2 (Side View): 3400-3800 MHz

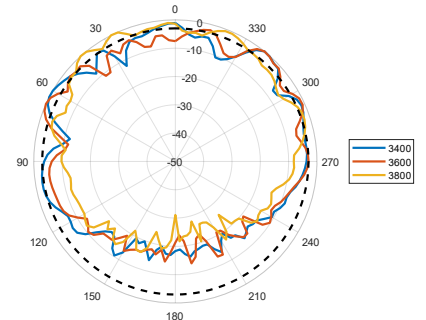

Radiation Patterns – Wi-Fi

Azimuth (Top View): 2400-2500 MHz

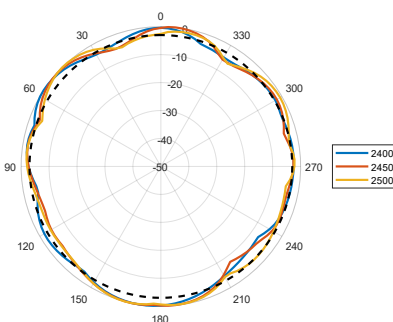

Azimuth (Top View): 5000-5400 MHz

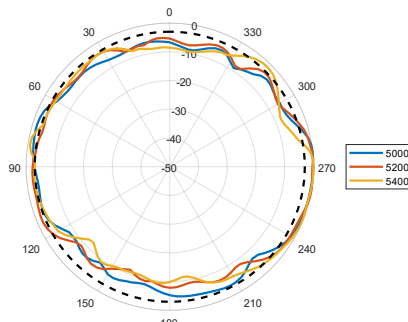

Azimuth (Top View): 5600-5800 MHz

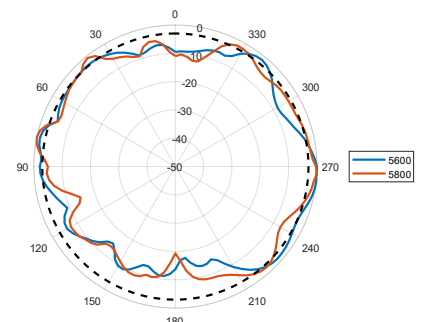

Azimuth (Top View): 6300-7200 MHz

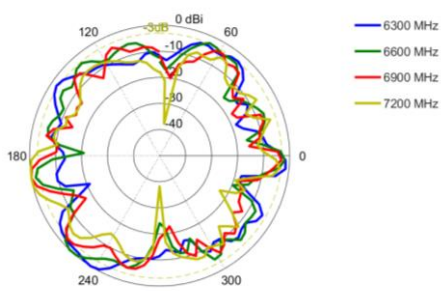

Elevation1 (Side View): 2400-2500 MHz

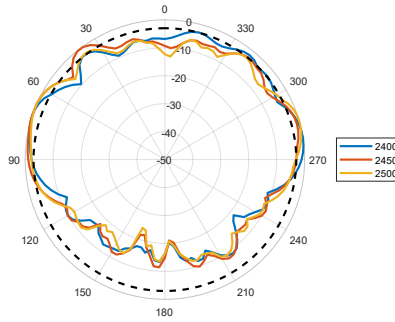

Elevation1 (Side View): 5000-5400 MHz

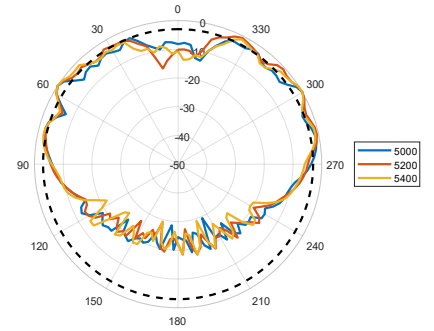

Elevation1 (Side View): 5600-5800 MHz

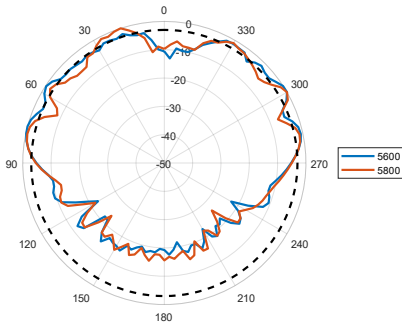

Elevation1 (Side View): 6300-7200 MHz

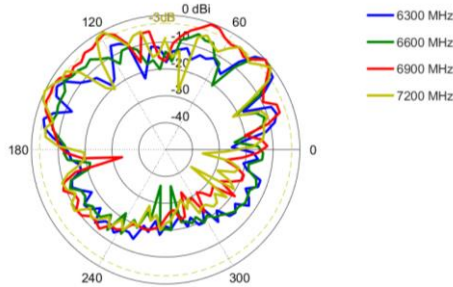

Elevation2 (Side View): 2400-2500 MHz

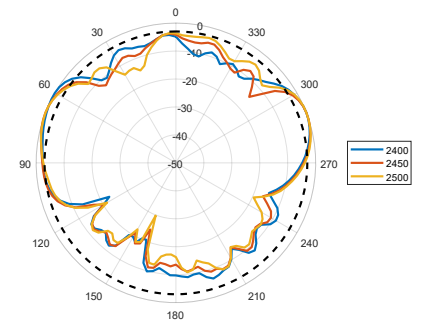

Elevation2 (Side View): 5000-5400 MHz

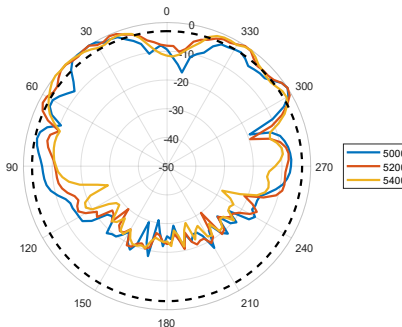

Elevation2 (Side View): 5600-5800 MHz

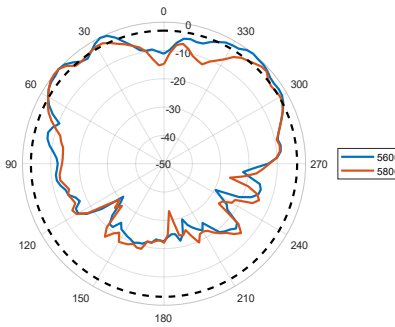

Radiation Patterns – GPS

XY Plane: 1561-1602 MHz

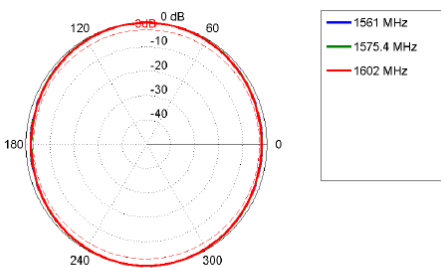

XZ Plane: 1561-1602 MHz

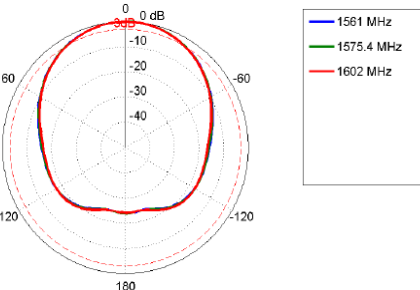

YZ Plane: 1561-1602 MHz

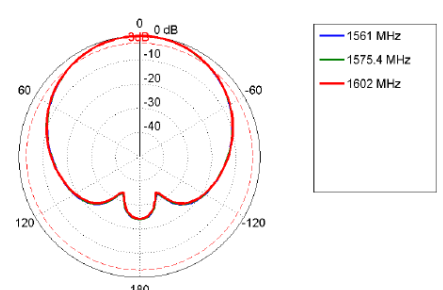

Mounting Options

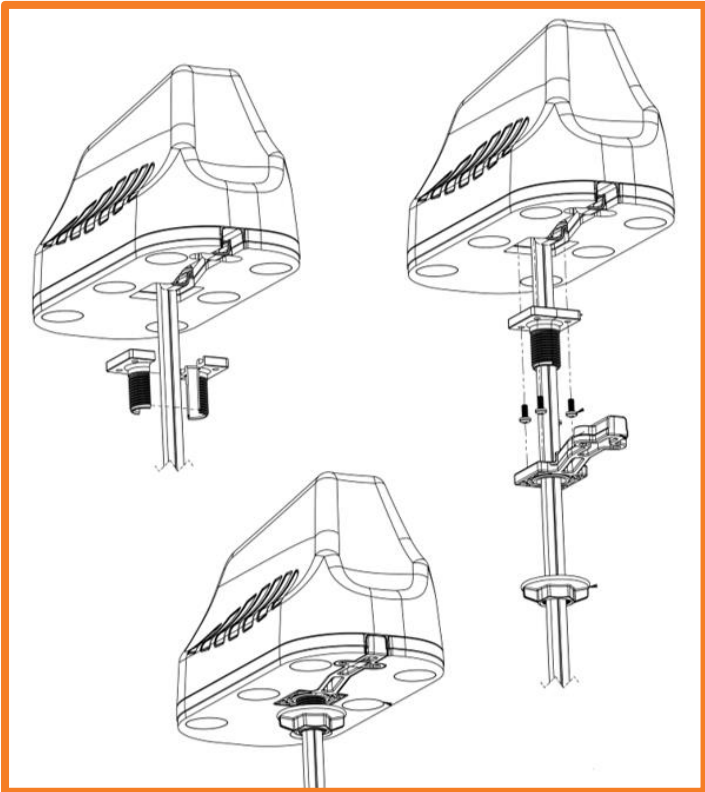

Standard Spigot Mount

Threaded Spigot Mounting

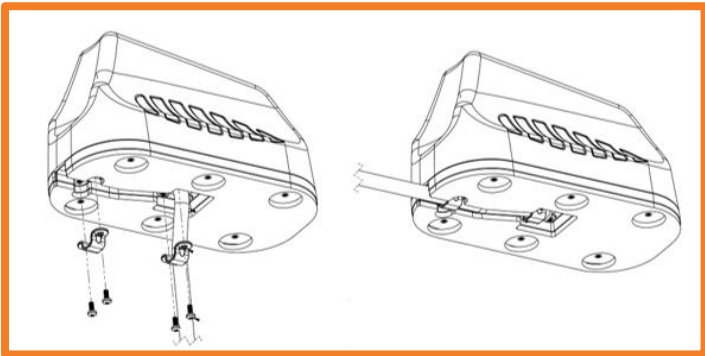

Surface Mount

Adhesive Surface Mounting

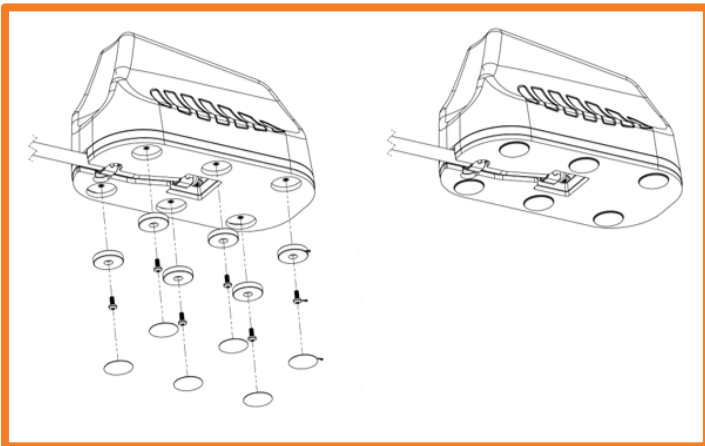

Magnetic Mount

Optional Magnetic Base Kit

Additional Accessories



A-MBK-0001-V1.0

Magnetic Base Kit



A-CAB-118

5 x 5m Extension cables for 5-in-1 Antennas



A-CAB-119

5 x 3m Extension cables for 5-in-1 Antennas

CONTACT POYNTING

Poynting Antennas (Pty) Ltd - Head Office

Unit 4, N1 Industrial Park,
Landmarks Avenue,
Samrand, 0157, South Africa

Phone: +27 (0) 12 657 0050

E-mail: info@poynting.tech

International Email: sales-global@poynting.tech

Poynting Europe

Regus Business Center Neue Messe Riem
Kronstadter Straße 4
81677 München
Germany

Phone: +49 89 7453 9002

E-mail: sales-europe@poynting.tech

Poynting USA

1804 Owen Court, Suite 104,
Mansfield,
TX 76063
USA

Phone: +1 817 533-8130

E-mail: sales-us@poynting.tech